



PCF8531

34 x 128 pixel matrix driver

Rev. 8 — 12 September 2014

Product data sheet

1. General description

The PCF8531 is a low-power CMOS¹ LCD row and column driver, designed to drive dot matrix graphic displays at multiplex rates of 1:17, 1:26, and 1:34. Furthermore, it can drive up to 128 icons. All necessary functions for the display are provided in a single chip, including on-chip generation of V_{LCD} and the LCD bias voltages, resulting in a minimum of external components and low power consumption. The PCF8531 is compatible with most microcontrollers and communicates via a two-line bidirectional I²C-bus. All inputs are CMOS compatible.

Remark: The icon mode is used to reduce current consumption. When only icons are displayed, a much lower operating voltage (V_{LCD}) can be used and the switching frequency of the LCD outputs is reduced. In most applications it is possible to use V_{DD} as V_{LCD} .

For a selection of NXP LCD graphic drivers, see [Table 20 on page 48](#).

2. Features and benefits

- Single-chip LCD controller and driver
- 34 row and 128 column outputs
- Display data RAM 34 × 128 bits
- 128 icons (last row is used for icons)
- Fast-mode I²C-bus interface (400 kbit/s)
- Software selectable multiplex rates: 1:17, 1:26, and 1:34
- Icon mode with multiplex rate 1:2:
 - ◆ Featuring reduced current consumption while displaying icons only
- On-chip:
 - ◆ Generation of V_{LCD} (external supply also possible)
 - ◆ Selectable linear temperature compensation
 - ◆ Oscillator requires no external components (external clock also possible)
 - ◆ Generation of intermediate LCD bias voltages
 - ◆ Power-On Reset (POR)
- No external components required
- Software selectable bias configuration
- Logic supply voltage range V_{DD1} to V_{SS1} : 1.8 V to 5.5 V
- Supply voltage range for on-chip voltage generator V_{DD2} and V_{DD3} to V_{SS1} and V_{SS2} : 2.5 V to 4.5 V
- Display supply voltage range V_{LCD} to V_{SS} :

1. The definition of the abbreviations and acronyms used in this data sheet can be found in [Section 21](#).



- ◆ Normal mode: 4 V to 9 V
- ◆ Icon mode: 3 V to 9 V
- Low-power consumption, suitable for battery operated systems
- CMOS compatible inputs
- Manufactured in silicon gate CMOS process

3. Applications

- Telecommunication systems
- Automotive information systems
- Point-of-sale terminals
- Instrumentation

4. Ordering information

Table 1. Ordering information

Type number	Package		
	Name	Description	Version
PCF8531U/2DA/1	-	chip with bumps in tray	-

4.1 Ordering options

Table 2. Ordering options

Product type number	Orderable part number	Sales item (12NC)	Delivery form	IC revision
PCF8531U/2DA/1	PCF8531U/2DA/1,026	935286602026	chips in tray	1

5. Block diagram

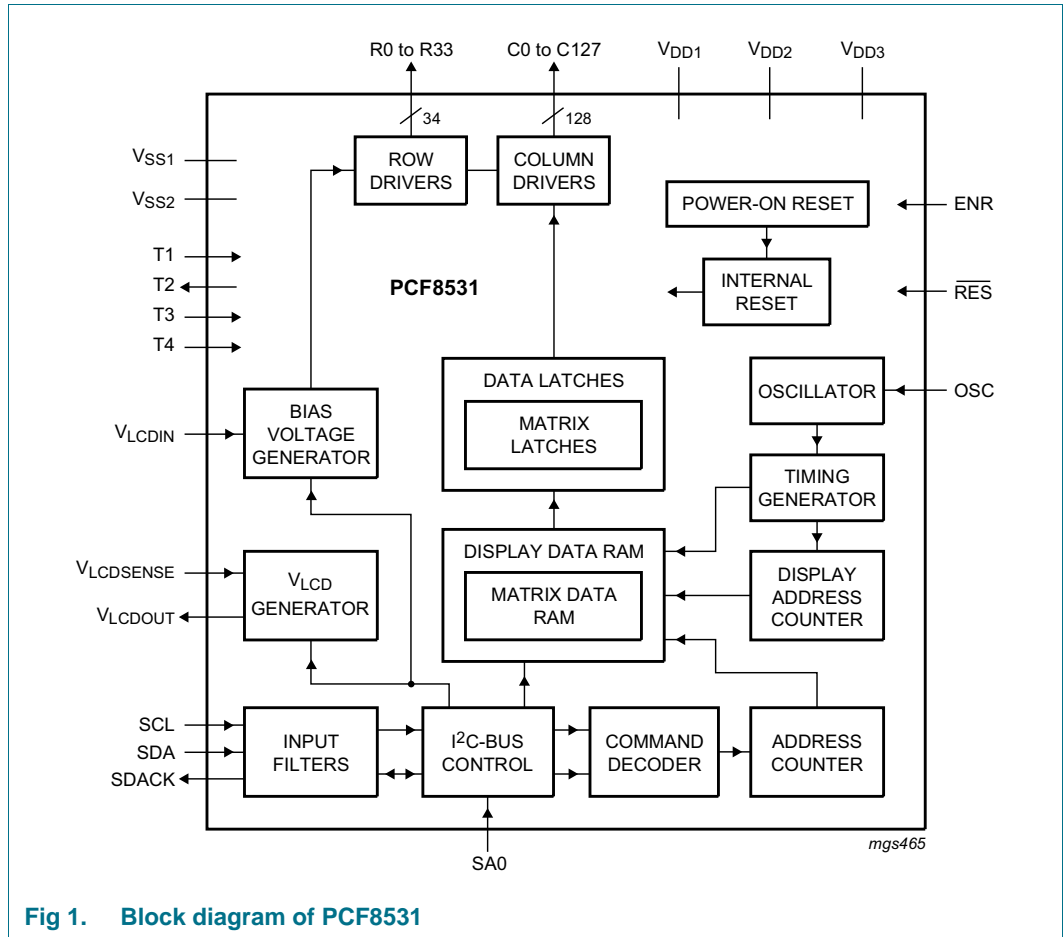

Fig 1. Block diagram of PCF8531

6. Pinning information

6.1 Pinning

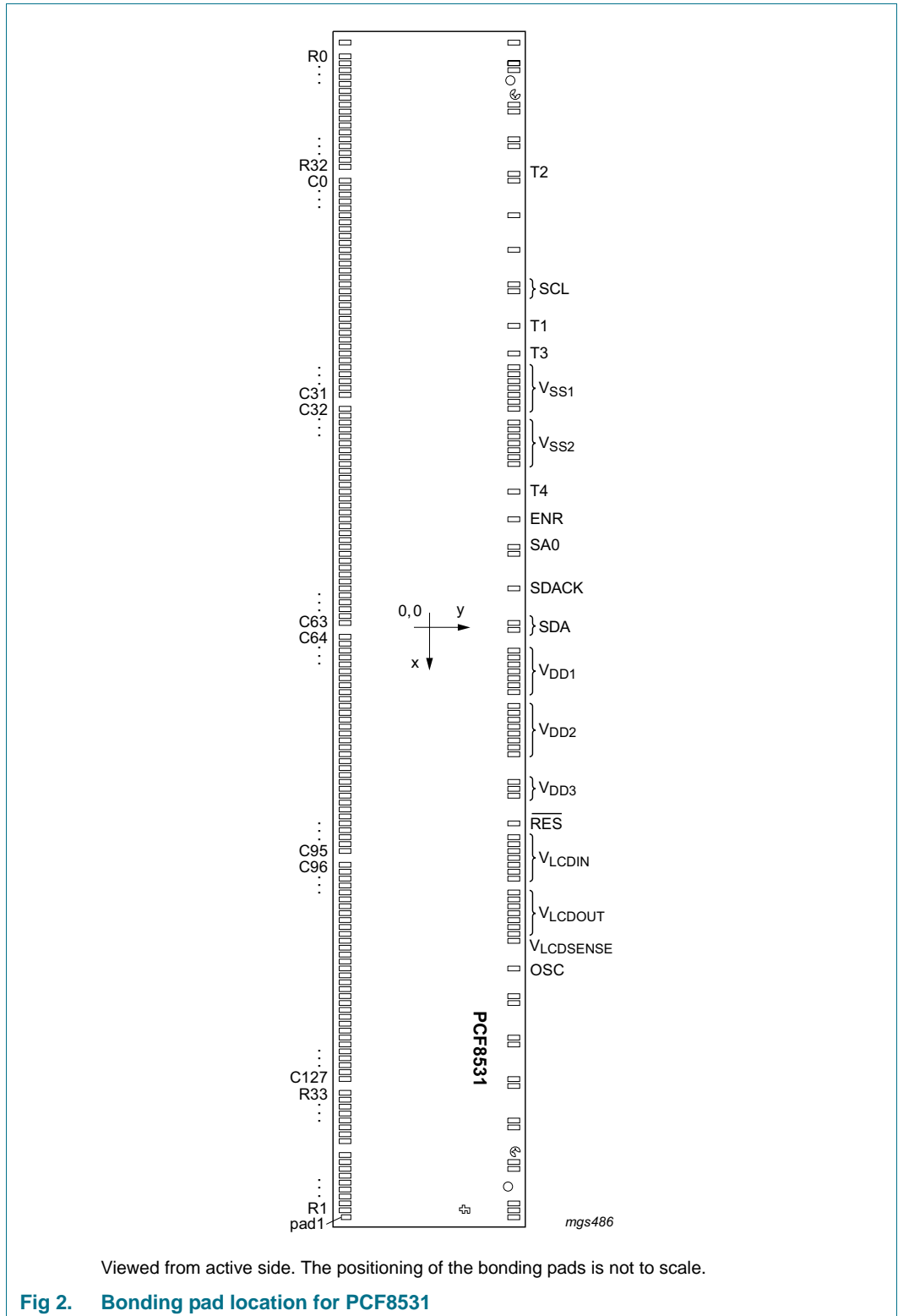

Table 3. Pad allocation table

Input or input/output pins must always be at a defined level (V_{SS} or V_{DD}) unless otherwise specified.

Pad	Symbol	Pad	Symbol
15	OSC	55	ENR
16	$V_{LCDSENSE}$	56	T4
17 to 23	V_{LCDOUT}	57 to 63	V_{SS2}
24 to 30	V_{LCDIN}	64 to 70	V_{SS1}
31	\overline{RES}	71	T3
32 to 34	V_{DD3}	72	T1
35 to 42	V_{DD2}	73 to 74	SCL
43 to 49	V_{DD1}	78	T2
50 to 51	SDA	87 to 103	R0, R2, R4, R6, R8, R10, R12, R14, R16, R18, R20, R22, R24, R26, R28, R30, R32
52	SDACK	104 to 231	C0 to C127
54	SA0	232 to 248	R33, R31, R29, R27, R25, R23, R21, R19, R17, R15, R13, R11, R9, R7, R5, R3, R1

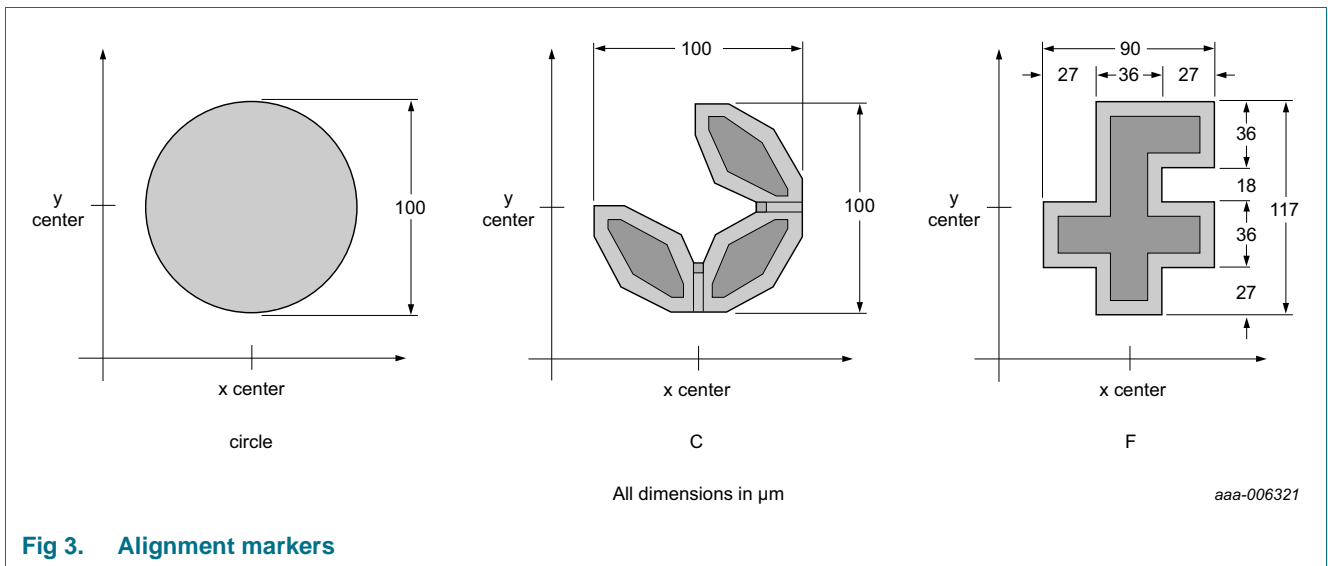

Table 4. Alignment markers for PCF8531

All x/y coordinates represent the position of the center of each pad with respect to the center (x/y = 0) of the chip (see Figure 2).

Alignment marks	x (μm)	y (μm)
C1	-5402.0	823.1
C2	5292.4	823.4
F	5890.3	401.9
circle 1	-5543.0	798.4
circle 2	5637.4	798.4

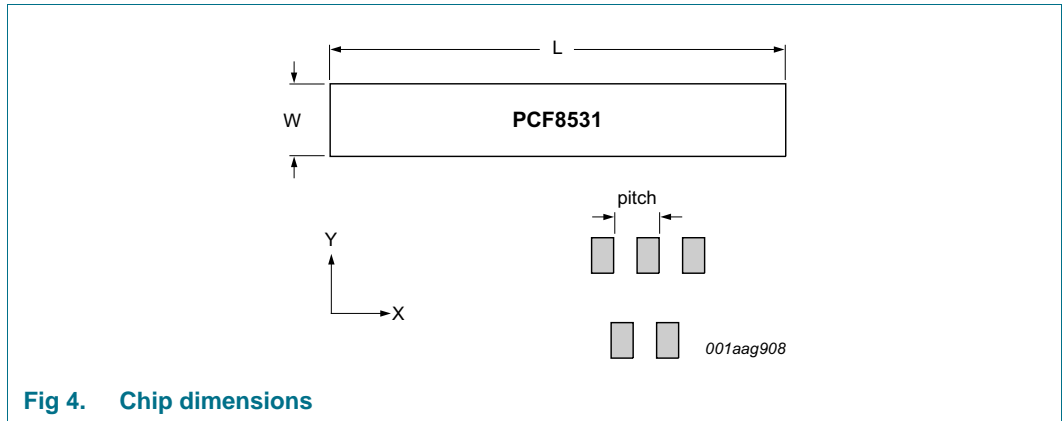

Fig 4. Chip dimensions

Table 5. Bonding pad dimensions

Pad	Size	Unit
pad pitch (minimum)	70	μm
bump dimensions	50 × 90 × 17.5 (±3)	μm
wafer thickness (excluding bumps)	381	μm
die size L × W	12.14 × 1.86 ^[1]	mm

[1] Die size including saw lane of 70 μm.

6.2 Pin description

Table 6. Bonding pad description

All x/y coordinates represent the position of the center of each pad with respect to the center (x/y = 0) of the chip (see [Figure 2](#)).

Symbol	Pad	X (μm)	Y (μm)	Description
-	1	5973.6	-821.7	dummy
-	2	5969.5	823.4	
-	3	5899.5	823.4	
-	4	5829.5	823.4	
-	5	5479.5	823.4	
-	6	5409.5	823.4	
-	7	5059.5	823.4	
-	8	4989.5	823.4	
-	9	4639.5	823.4	
-	10	4569.5	823.4	
-	11	4219.5	823.4	
-	12	4149.5	823.4	
-	13	3799.5	823.4	
-	14	3729.5	823.4	
OSC	15	3449.5	823.4	oscillator input ^[1]
V _{LCDSENSE}	16	3169.5	823.4	voltage multiplier regulation input (V _{LCD}) ^[2]

Table 6. Bonding pad description ...continued

All x/y coordinates represent the position of the center of each pad with respect to the center (x/y = 0) of the chip (see [Figure 2](#)).

Symbol	Pad	X (μm)	Y (μm)	Description	
V _{LCDOUT}	17	3099.5	823.4	voltage multiplier output (V _{LCD})	[3]
V _{LCDOUT}	18	3029.5	823.4		
V _{LCDOUT}	19	2959.5	823.4		
V _{LCDOUT}	20	2889.5	823.4		
V _{LCDOUT}	21	2819.5	823.4		
V _{LCDOUT}	22	2749.5	823.4		
V _{LCDOUT}	23	2679.5	823.4		
V _{LCDIN}	24	2539.5	823.4	LCD supply voltage (V _{LCD})	[2]
V _{LCDIN}	25	2469.5	823.4		
V _{LCDIN}	26	2399.5	823.4		
V _{LCDIN}	27	2329.5	823.4		
V _{LCDIN}	28	2259.5	823.4		
V _{LCDIN}	29	2189.5	823.4		
V _{LCDIN}	30	2119.5	823.4		
RES	31	1979.5	823.4	external reset input (active LOW)	[4]
V _{DD3}	32	1699.5	823.4	supply voltage 3	[5]
V _{DD3}	33	1629.5	823.4		
V _{DD3}	34	1559.5	823.4		
V _{DD2}	35	1279.5	823.4	supply voltage 2	[5]
V _{DD2}	36	1209.5	823.4		
V _{DD2}	37	1139.5	823.4		
V _{DD2}	38	1069.5	823.4		
V _{DD2}	39	999.5	823.4	supply voltage 2	[5]
V _{DD2}	40	929.5	823.4		
V _{DD2}	41	859.5	823.4		
V _{DD2}	42	789.5	823.4		
V _{DD2}	43	649.5	823.4		
V _{DD1}	44	579.5	823.4	supply voltage 1	[5]
V _{DD1}	45	509.5	823.4		
V _{DD1}	46	439.5	823.4		
V _{DD1}	47	369.5	823.4		
V _{DD1}	48	299.5	823.4		
V _{DD1}	49	229.5	823.4		
SDA	50	19.5	823.4	serial data line input of the I ² C-bus	
SDA	51	-50.5	823.4		
SDACK	52	-400.5	823.4	serial data acknowledge output	[6]
-	53	-750.5	823.4	dummy	
SA0	54	-820.5	823.4	I ² C-bus slave address input; bit 0	
ENR	55	-1100.5	823.4	enable internal Power-On Reset (POR) input	[7]

Table 6. Bonding pad description ...continued

All x/y coordinates represent the position of the center of each pad with respect to the center (x/y = 0) of the chip (see [Figure 2](#)).

Symbol	Pad	X (μm)	Y (μm)	Description	
T4	56	-1380.5	823.4	test input 4	[8]
V _{SS2}	57	-1660.5	823.4	ground 2	[9]
V _{SS2}	58	-1730.5	823.4		
V _{SS2}	59	-1800.5	823.4		
V _{SS2}	60	-1870.5	823.4		
V _{SS2}	61	-1940.5	823.4		
V _{SS2}	62	-2010.5	823.4		
V _{SS2}	63	-2080.5	823.4		
V _{SS1}	64	-2220.5	823.4	ground 1	[9]
V _{SS1}	65	-2290.5	823.4		
V _{SS1}	66	-2360.5	823.4		
V _{SS1}	67	-2430.5	823.4		
V _{SS1}	68	-2500.5	823.4		
V _{SS1}	69	-2570.5	823.4		
V _{SS1}	70	-2640.5	823.4		
T3	71	-2780.5	823.4	test 3	[8]
T1	72	-3060.5	823.4	test 1	[8]
SCL	73	-3410.5	823.4	serial clock line input of the I ² C-bus	
SCL	74	-3480.5	823.4		
-	75	-3830.5	823.4	dummy	
-	76	-4180.5	823.4		
-	77	-4530.5	823.4		
T2	78	-4600.5	823.4	test 2 output	[10]
-	79	-4880.5	823.4	dummy	
-	80	-4950.5	823.4		
-	81	-5230.5	823.4		
-	82	-5300.5	823.4		
-	83	-5650.5	823.4		
-	84	-5720.5	823.4		
-	85	-5930.5	823.4		
-	86	-5926.4	-821.7		
R0	87	-5786.4	-821.7	LCD row driver output	
R2	88	-5716.4	-821.7		
R4	89	-5646.4	-821.7		
R6	90	-5576.4	-821.7		
R8	91	-5506.4	-821.7		
R10	92	-5436.4	-821.7		
R12	93	-5366.4	-821.7		
R14	94	-5296.4	-821.7		

Table 6. Bonding pad description ...continued

All x/y coordinates represent the position of the center of each pad with respect to the center (x/y = 0) of the chip (see [Figure 2](#)).

Symbol	Pad	X (μm)	Y (μm)	Description
R16	95	-5226.4	-821.7	LCD row driver output
R18	96	-5156.4	-821.7	
R20	97	-5086.4	-821.7	
R22	98	-5016.4	-821.7	
R24	99	-4946.4	-821.7	
R26	100	-4876.4	-821.7	
R28	101	-4806.4	-821.7	
R30	102	-4736.4	-821.7	
R32	103	-4666.4	-821.7	
C0	104	-4526.4	-821.7	
C1	105	-4456.4	-821.7	
C2	106	-4386.4	-821.7	
C3	107	-4316.4	-821.7	
C4	108	-4246.4	-821.7	
C5	109	-4176.4	-821.7	
C6	110	-4106.4	-821.7	
C7	111	-4036.4	-821.7	
C8	112	-3966.4	-821.7	
C9	113	-3896.4	-821.7	
C10	114	-3826.4	-821.7	
C11	115	-3756.4	-821.7	
C12	116	-3686.4	-821.7	
C13	117	-3616.4	-821.7	
C14	118	-3546.4	-821.7	
C15	119	-3476.4	-821.7	
C16	120	-3406.4	-821.7	
C17	121	-3336.4	-821.7	
C18	122	-3266.4	-821.7	
C19	123	-3196.4	-821.7	
C20	124	-3126.4	-821.7	
C21	125	-3056.4	-821.7	
C22	126	-2986.4	-821.7	
C23	127	-2916.4	-821.7	
C24	128	-2846.4	-821.7	
C25	129	-2776.4	-821.7	
C26	130	-2706.4	-821.7	
C27	131	-2636.4	-821.7	
C28	132	-2566.4	-821.7	
C29	133	-2496.4	-821.7	

Table 6. Bonding pad description ...continued

All x/y coordinates represent the position of the center of each pad with respect to the center (x/y = 0) of the chip (see [Figure 2](#)).

Symbol	Pad	X (μm)	Y (μm)	Description
C30	134	-2426.4	-821.7	LCD column driver output
C31	135	-2356.4	-821.7	
C32	136	-2216.4	-821.7	
C33	137	-2146.4	-821.7	
C34	138	-2076.4	-821.7	
C35	139	-2006.4	-821.7	
C36	140	-1936.4	-821.7	
C37	141	-1866.4	-821.7	
C38	142	-1796.4	-821.7	
C39	143	-1726.4	-821.7	
C40	144	-1656.4	-821.7	
C41	145	-1586.4	-821.7	
C42	146	-1516.4	-821.7	
C43	147	-1446.4	-821.7	
C44	148	-1376.4	-821.7	
C45	149	-1306.4	-821.7	
C46	150	-1236.4	-821.7	
C47	151	-1166.4	-821.7	
C48	152	-1096.4	-821.7	
C49	153	-1026.4	-821.7	
C50	154	-956.4	-821.7	
C51	155	-886.4	-821.7	
C52	156	-816.4	-821.7	
C53	157	-746.4	-821.7	
C54	158	-676.4	-821.7	
C55	159	-606.4	-821.7	
C56	160	-536.4	-821.7	
C57	161	-466.4	-821.7	
C58	162	-396.4	-821.7	
C59	163	-326.4	-821.7	
C60	164	-256.4	-821.7	
C61	165	-186.4	-821.7	
C62	166	-116.6	-821.7	
C63	167	-46.4	-821.7	
C64	168	93.6	-821.7	
C65	169	163.6	-821.7	
C66	170	233.6	-821.7	
C67	171	303.6	-821.7	
C68	172	373.6	-821.7	

Table 6. Bonding pad description ...continued

All x/y coordinates represent the position of the center of each pad with respect to the center (x/y = 0) of the chip (see [Figure 2](#)).

Symbol	Pad	X (μm)	Y (μm)	Description
C69	173	443.6	-821.7	LCD column driver output
C70	174	513.6	-821.7	
C71	175	583.6	-821.7	
C72	176	653.6	-821.7	
C73	177	723.6	-821.7	
C74	178	793.6	-821.7	
C75	179	863.6	-821.7	
C76	180	933.6	-821.7	
C77	181	1003.6	-821.7	
C78	182	1073.6	-821.7	
C79	183	1143.6	-821.7	
C80	184	1213.6	-821.7	
C81	185	1283.6	-821.7	
C82	186	1353.6	-821.7	
C83	187	1423.6	-821.7	
C84	188	1493.6	-821.7	
C85	189	1563.6	-821.7	
C86	190	1633.6	-821.7	
C87	191	1703.6	-821.7	
C88	192	1773.6	-821.7	
C89	193	1843.6	-821.7	
C90	194	1913.6	-821.7	
C91	195	1983.6	-821.7	
C92	196	2053.6	-821.7	
C93	197	2123.6	-821.7	
C94	198	2193.6	-821.7	
C95	199	2263.6	-821.7	
C96	200	2403.6	-821.7	
C97	201	2473.6	-821.7	
C98	202	2543.6	-821.7	
C99	203	2613.6	-821.7	
C100	204	2683.6	-821.7	
C101	205	2753.6	-821.7	
C102	206	2823.6	-821.7	
C103	207	2893.6	-821.7	
C104	208	2963.6	-821.7	
C105	209	3033.6	-821.7	
C106	210	3103.6	-821.7	
C107	211	3173.6	-821.7	

Table 6. Bonding pad description ...continued

All x/y coordinates represent the position of the center of each pad with respect to the center (x/y = 0) of the chip (see [Figure 2](#)).

Symbol	Pad	X (μm)	Y (μm)	Description
C108	212	3243.6	-821.7	LCD column driver output
C109	213	3313.6	-821.7	
C110	214	3383.6	-821.7	
C111	215	3453.6	-821.7	
C112	216	3523.6	-821.7	
C113	217	3593.6	-821.7	
C114	218	3663.6	-821.7	
C115	219	3733.6	-821.7	
C116	220	3803.6	-821.7	
C117	221	3873.6	-821.7	
C118	222	3943.6	-821.7	
C119	223	4013.6	-821.7	
C120	224	4083.6	-821.7	
C121	225	4153.6	-821.7	
C122	226	4223.6	-821.7	
C123	227	4293.6	-821.7	
C124	228	4363.6	-821.7	
C125	229	4433.6	-821.7	
C126	230	4503.6	-821.7	
C127	231	4573.6	-821.7	
R33	232	4713.6	-821.7	LCD row driver output; icon row
R31	233	4783.6	-821.7	LCD row driver output
R29	234	4853.6	-821.7	
R27	235	4923.6	-821.7	
R25	236	4993.6	-821.7	
R23	237	5063.6	-821.7	
R21	238	5133.6	-821.7	
R19	239	5203.6	-821.7	
R17	240	5343.6	-821.7	
R15	241	5413.6	-821.7	
R13	242	5483.6	-821.7	
R11	243	5553.6	-821.7	
R9	244	5623.6	-821.7	
R7	245	5693.6	-821.7	
R5	246	5763.6	-821.7	
R3	247	5833.6	-821.7	
R1	248	5903.6	-821.7	

[1] If the on-chip oscillator is used, this input must be connected to V_{DD1}.

[2] If the internal V_{LCD} generation is used, V_{LCDOUT}, V_{LCDIN}, and V_{LCDSENSE} must be connected together.

- [3] If an external V_{LCD} is used in the application, then pin V_{LCDOUT} must be left open-circuit, otherwise the chip will be damaged.
- [4] If only the internal Power-On Reset (POR) is used, this input must be connected to V_{DD1} .
- [5] V_{DD1} is for the logic supply, V_{DD2} and V_{DD3} are for the voltage multiplier. For split power supplies, V_{DD2} and V_{DD3} must be connected together. If only one supply voltage is available, V_{DD1} , V_{DD2} , and V_{DD3} must be connected together.
- [6] Serial data acknowledge for the I²C-bus. By connecting SDACK to SDA externally, the SDA line becomes fully I²C-bus compatible. Having the acknowledge output separated from the serial data line is advantageous in Chip-On-Glass (COG) applications. In COG applications where the track resistance from the SDACK pad to the system SDA line can be significant, a potential divider is generated by the bus pull-up resistor and the Indium Tin Oxide (ITO) track resistance. It is possible that the PCF8531 will not be able to create a valid logic 0 level during the acknowledge cycle. By splitting the SDA input from the SDACK output, the device could be used in a mode that ignores the acknowledge bit. In COG applications where the acknowledge cycle is required, it is necessary to minimize the track resistance from the SDACK pad to the system SDA line to guarantee a valid LOW level.
- [7] If ENR is connected to V_{SS} , Power-On Reset (POR) is disabled; to enable Power-On Reset (POR) ENR must be connected to V_{DD1} .
- [8] In the application, this input must be connected to V_{SS} .
- [9] V_{SS1} and V_{SS2} must be connected together.
- [10] In the application, T2 must be left open-circuit.

7. Functional description

7.1 Oscillator

The on-chip oscillator provides the clock signal for the display system. No external components are required and the OSC input must be connected to V_{DD} . An external clock signal, if used, is connected to this input.

7.2 Power-On Reset (POR)

The on-chip Power-On Reset (POR) initializes the chip after power-on or power failure.

7.3 I²C-bus controller

The I²C-bus controller receives and executes the commands. The PCF8531 acts as an I²C-bus slave receiver and therefore it cannot control bus communication.

7.4 Input filters

To enhance noise immunity in electrically adverse environments, RC low-pass filters are provided on the SDA and SCL lines.

7.5 Display data RAM

The PCF8531 contains 34×128 bits static RAM for storing the display data, see [Figure 7](#). The RAM is divided into 6 banks of 128 bytes ($6 \times 8 \times 128$ bits). Bank 5 is used for icon data. During RAM access, data is transferred to the RAM via the I²C-bus interface. There is a direct correspondence between the X address and column output number.

7.6 Timing generator

The timing generator produces the various signals required to drive the internal circuitry. Internal chip operation is not affected by operations on the data buses.

7.7 Address counter

The address counter sets the addresses of the display data RAM for writing.

7.8 Display address counter

The display address counter generates the addresses for read out of the display data.

7.9 Command decoder

The command decoder identifies command words that arrive on the I²C-bus and determines the destination for the following data bytes.

7.10 Bias voltage generator

The bias voltage generator generates four buffered intermediate bias voltages. This block contains the generator for the reference voltages and the four buffers. This block can operate in two voltage ranges:

- Normal mode: 4.0 V to 9.0 V
- Power save mode: 3.0 V to 9.0 V.

7.11 V_{LCD} generator

The V_{LCD} voltage generator contains a configurable 2 to 5 times voltage multiplier; this is programmed by software.

7.12 Reset

The PCF8531 has the possibility of two reset modes: internal Power-On Reset (POR) or external reset ($\overline{\text{RES}}$). The reset mode is selected using the ENR signal. After a reset, the chip has the following state:

- All row and column outputs are set to V_{SS} (display off)
- RAM data is undefined
- Power-down mode

7.13 Power-down

During power-down, all static currents are switched off (no internal oscillator, no timing and no LCD segment drive system) and all LCD outputs are internally connected to V_{SS} . The I²C-bus function remains operational.

7.14 Column driver outputs

The LCD drive section includes 128 column outputs (C0 to C127) which must be connected directly to the LCD. The column output signals are generated in accordance with the multiplexed row signals and with the data in the display latch. When less than 128 columns are required, the unused column outputs must be left open-circuit.

7.15 Row driver outputs

The LCD drive section includes 34 row outputs (R0 to R33), which must be connected directly to the LCD. The row output signals are generated in accordance with the selected LCD drive mode. If less than 34 rows or lower multiplex rates are required, the unused outputs must be left open-circuit. The row signals are interlaced i.e. the selection order is R0, R2, ..., R1, R3, etc.

8. LCD waveforms and DDRAM to data mapping

The LCD waveforms and the DDRAM to display data mapping are shown in [Figure 5](#), [Figure 6](#) and [Figure 7](#).

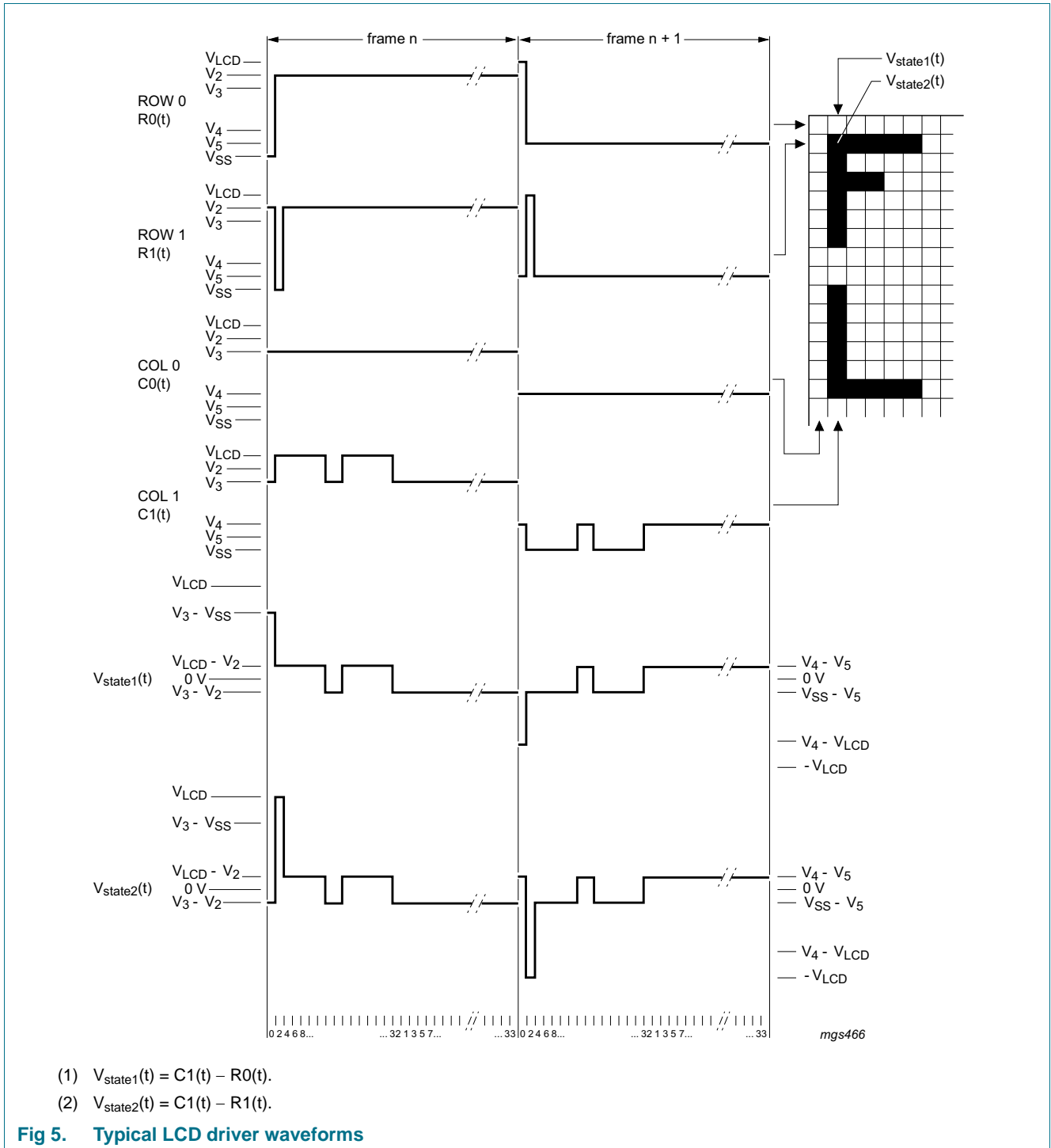

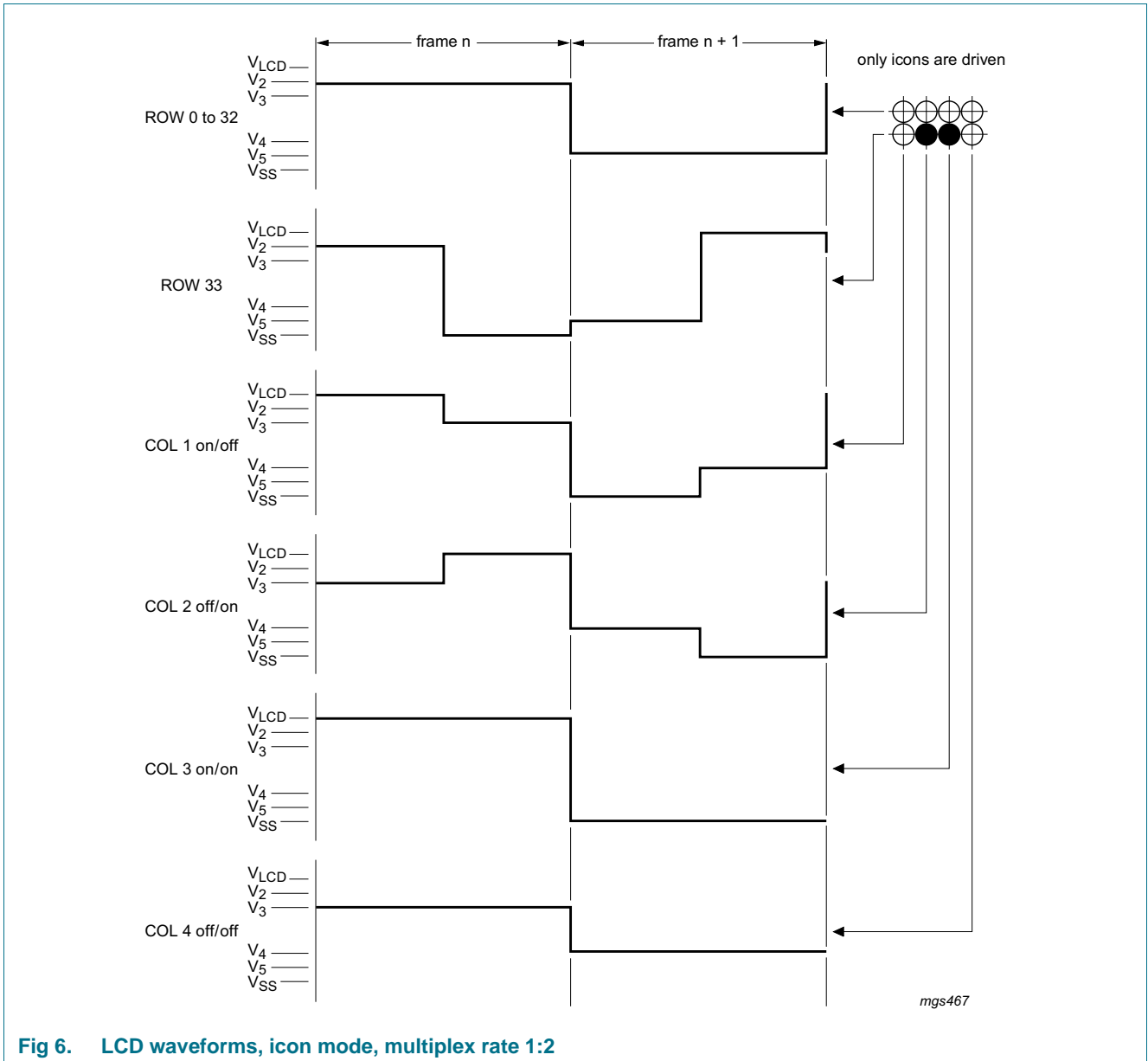

Fig 6. LCD waveforms, icon mode, multiplex rate 1:2

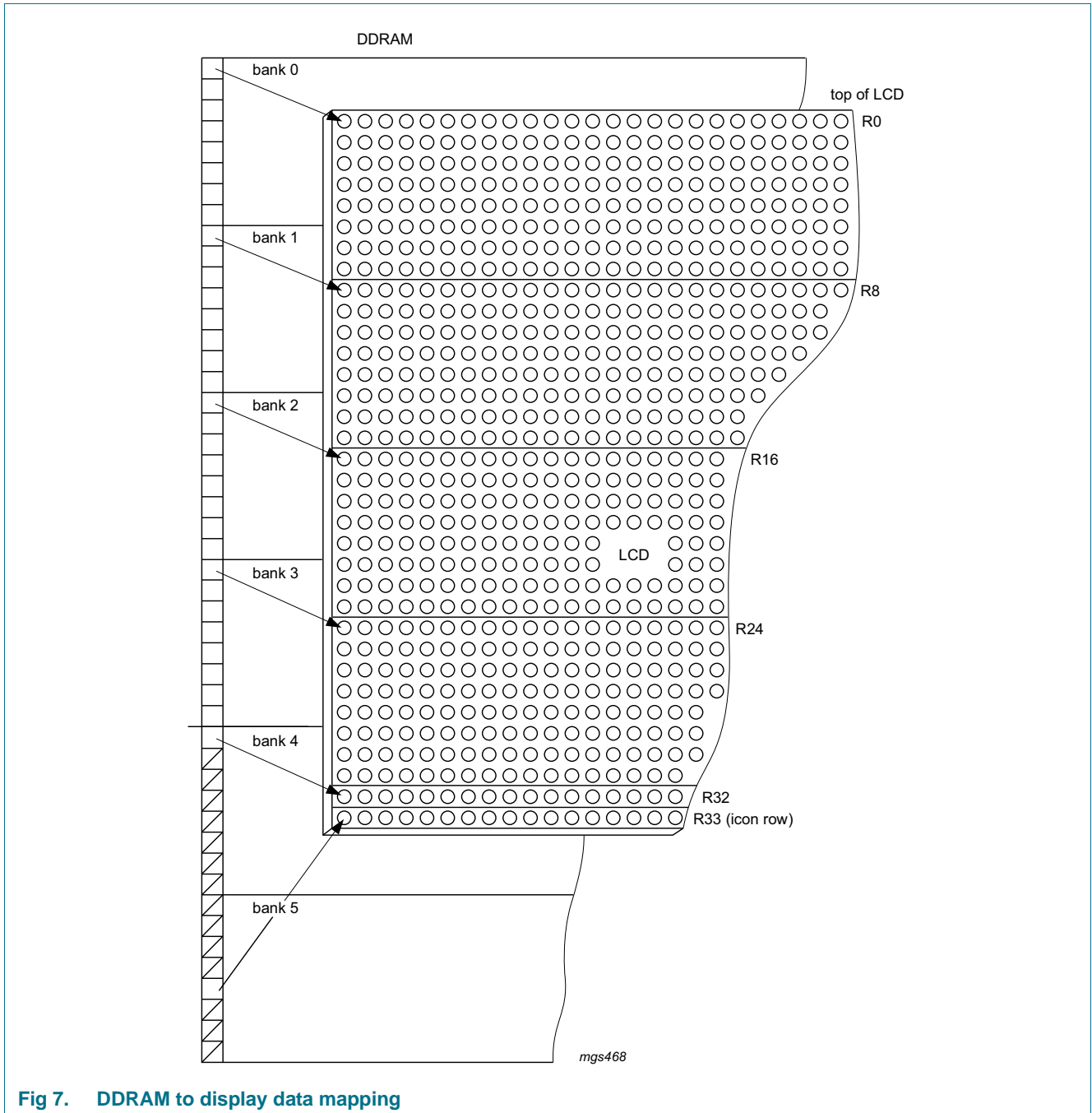

Fig 7. DDRAM to display data mapping

8.1 Addressing

Data is written in bytes into the RAM matrix of the PCF8531 as shown in [Figure 8](#), [Figure 9](#) and [Figure 10](#). The display RAM has a matrix of 34 × 128 bits. The columns are addressed by the address pointer. The address ranges are X 0 to X 127 (7Fh) and Y 0 to Y 5 (5h). Addresses outside of these ranges are not allowed. In vertical addressing mode (V = 1), the Y address increments after each byte (see [Figure 9](#)). After the last Y address (Y = 4), Y wraps around to 0 and X increments to address the next column. In horizontal addressing mode (V = 0), the X address increments after each byte (see [Figure 10](#)). After the last X address (X = 127), X wraps around to 0 and Y increments to address the next

row. After the very last address (X = 127 and Y = 4), the address pointers wrap around to address (X = 0 and Y = 0). The Y address 5 is reserved for icon data and is not affected by the addressing mode. Please note that in bank 4 only the LSB (DB0) of the data is written into the RAM and in bank 5 only the 5th data bit (DB4) is written into the RAM.

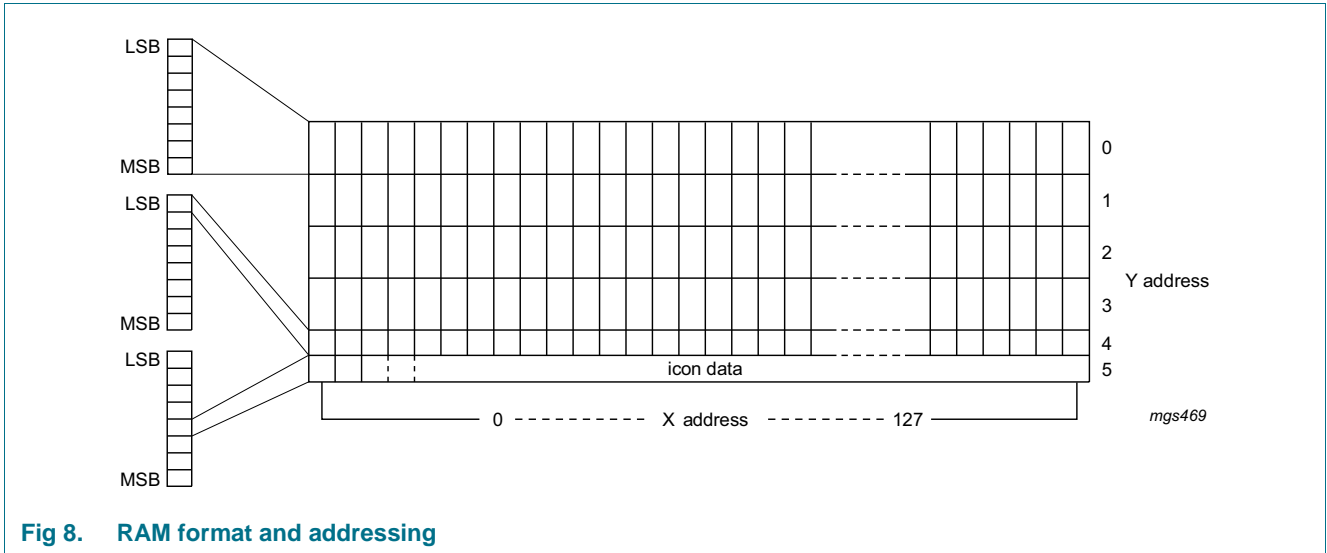

Fig 8. RAM format and addressing

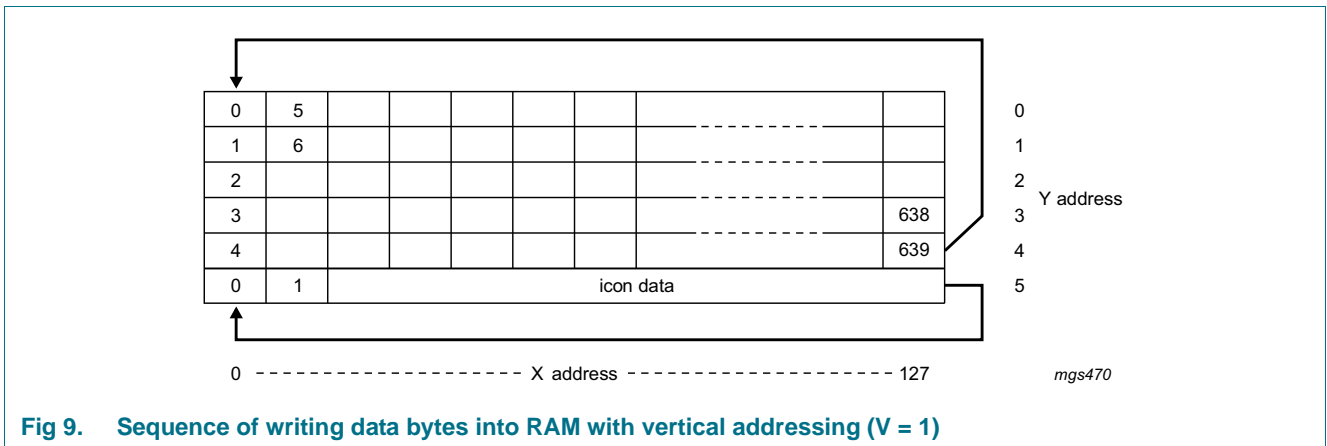

Fig 9. Sequence of writing data bytes into RAM with vertical addressing (V = 1)

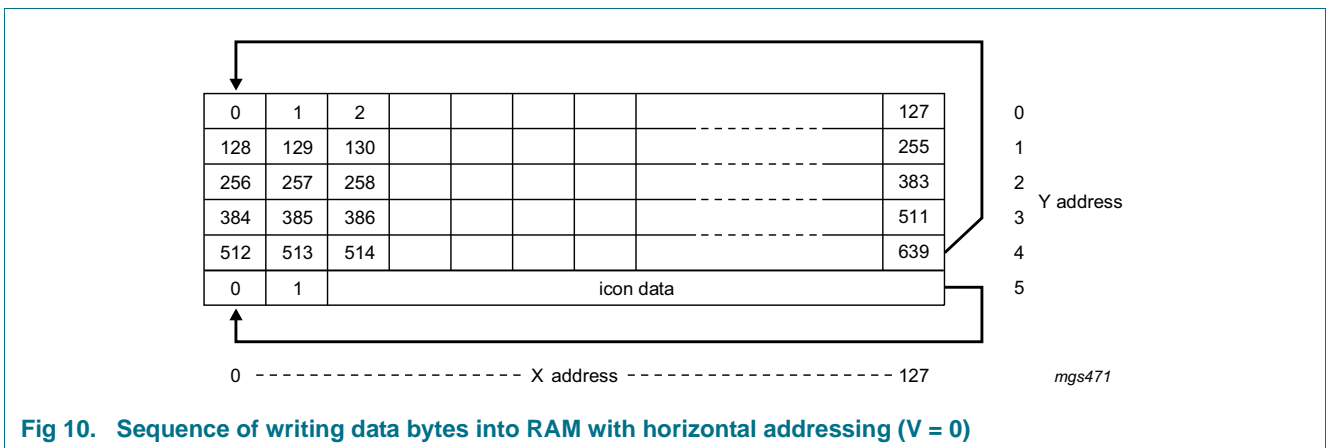

Fig 10. Sequence of writing data bytes into RAM with horizontal addressing (V = 0)

9. Instructions

Only two PCF8531 registers, the instruction register and the data register can be directly controlled by the MPU. Before internal operation, control information is stored temporarily in these registers to allow interfacing to various types of MPUs which operate at different speeds or to allow interfacing to peripheral control ICs. The PCF8531 operation is controlled by the instructions given in [Table 12](#).

Instructions are of four types:

- Those that define PCF8531 functions e.g. display configuration, etc.
- Those that set internal RAM addresses
- Those that perform data transfer to/from the internal RAM
- Others

In normal mode instructions which perform data transfer to/from the internal RAM are used most frequently. Automatic incrementing by 1 of internal RAM addresses after each data write reduces the MPU program load.

9.1 Reset

After reset or internal Power-On Reset (POR) (depending on the application), the LCD driver is set to the following state:

- Power-down mode (PD = 1)
- Horizontal addressing (V = 0)
- Display blank (D = 0; E = 0), no icon mode (IM = 0)
- Address counter X[6:0] = 0; Y[2:0] = 0
- Bias system BS[2:0] = 0
- Multiplex rate M[1:0] = 0 (multiplex rate 1:17)
- Temperature control mode TC[2:0] = 0
- HV-gen control, HVE = 0 the high voltage (HV) generator is switched off, PRS = 0 and S[1:0] = 0
- $V_{\text{LCD}} = 0 \text{ V}$
- RAM data is undefined
- Command page definition H[1:0] = 0

9.2 Function set

9.2.1 PD

When PD = 1, the power-down mode of the LCD driver is active:

- All LCD outputs at V_{SS} (display off)
- Power-On Reset (POR) detection active, oscillator off
- V_{LCD} can be disconnected
- I²C-bus is operational, commands can be executed
- RAM contents not cleared; RAM data can be written
- Register settings remain unchanged

9.2.2 V

When V = 0 the horizontal addressing is selected. The data is written into the DDRAM as shown in [Figure 10](#). When V = 1 the vertical addressing is selected. The data is written into the DDRAM as shown in [Figure 9](#). Icon data is written independently of V when Y address is 5.

9.3 Set Y address

Bits Y2, Y1, and Y0 define the Y address vector of the display RAM (see [Table 7](#)).

Table 7. Y address

Y2	Y1	Y0	Bank
0	0	0	0
0	0	1	1
0	1	0	2
0	1	1	3
1	0	0	4
1	0	1	5 (icons)

9.4 Set X address

The X address points to the columns. The range of X is 0 to 127 (7Fh).

9.5 Set multiplex rate

M[1:0] selects the multiplex rate (see [Table 8](#)).

Table 8. Multiplex rates

Multiplex rate	M1	M0
1:17	0	0
1:26	1	0
1:34	0	1

9.6 Display control (D, E, and IM)

Bits D and E select the display mode (see [Table 14](#)). Bit IM (see [Table 13](#)) sets the display to icon mode.

9.7 Set bias system

The bias voltage levels are set in the ratio of R – R – n × R – R – R (see [Figure 11](#)).

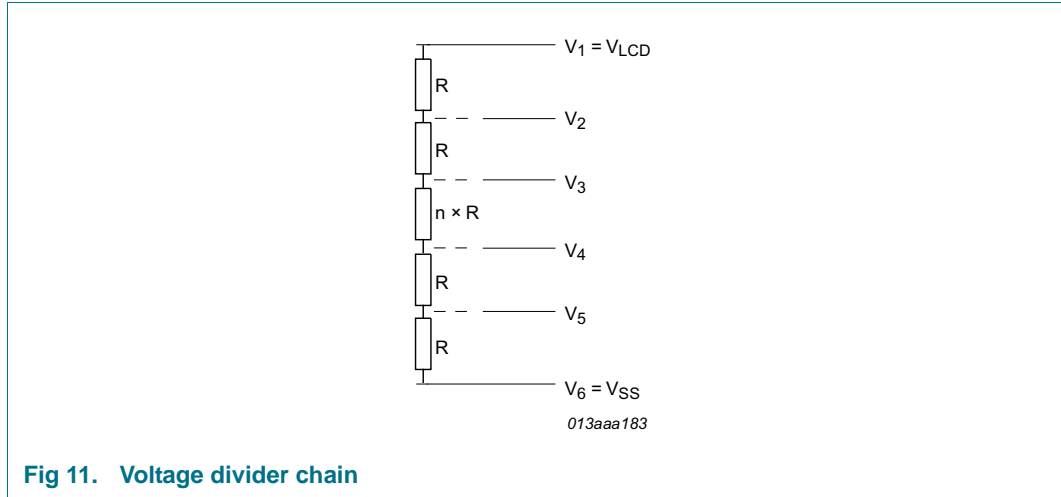

Fig 11. Voltage divider chain

Different multiplex rates require different bias settings. Bias settings are programmed by BS[2:0], which sets the binary number n. The optimum value for n is given by:

$$n = \sqrt{\text{muxrate}} - 3$$

Supported values of n are given in [Table 9](#). [Table 10](#) shows the intermediate bias voltages.

Table 9. Programming the required bias system

BS[2:0]	n	Bias system	Comment
000	7	1/11	-
001	6	1/10	-
010	5	1/9	-
011	4	1/8	-
100	3	1/7	recommended for 1:34
101	2	1/6	recommended for 1:26
110	1	1/5	recommended for 1:17
111	0	1/4	recommended for icon mode

9.8 LCD bias voltage

Table 10. Intermediate LCD bias voltages

Symbol	Bias voltage	Example for 1/7 bias
V1	V _{LCD}	V _{LCD}
V2	$\frac{n+3}{n+4} \times V_{LCD}$	$\frac{6}{7} \times V_{LCD}$
V3	$\frac{n+2}{n+4} \times V_{LCD}$	$\frac{5}{7} \times V_{LCD}$
V4	$\frac{2}{n+4} \times V_{LCD}$	$\frac{2}{7} \times V_{LCD}$
V5	$\frac{1}{n+4} \times V_{LCD}$	$\frac{1}{7} \times V_{LCD}$
V6	V _{SS}	V _{SS}

9.9 Set V_{LCD} value

V_{LCD} can be set by software. The voltage at intersection temperature [V_{LCD} (T = T_{ints})] can be calculated as: V_{LCD} (T_{ints}) = a + V_{LCD} × b

The generated voltage is dependent on the temperature, programmed Temperature Coefficient (TC) and the programmed voltage at intersection temperature (T_{ints}).

$$V_{LCD} = V_{LCD} (T_{ints}) \times [1 + TC \times (T - T_{ints})]$$

The parameter values are given in [Table 11](#). Two overlapping V_{LCD} ranges can be selected via the command HV-gen control (see [Table 11](#) and [Figure 12](#)). The maximum voltage which can be generated depends on the V_{DD2} and V_{DD3} voltages and the display load current. For multiplex rate 1:34, the optimum V_{LCD} can be calculated as:

$$V_{LCD} = \frac{1 + \sqrt{34}}{\sqrt{2 \times \left(1 - \frac{1}{\sqrt{34}}\right)}} \times V_{th} = 5.30 \times V_{th}$$

Where V_{th} is the threshold voltage of the liquid crystal material used.

The practical value for V_{LCD} is determined by equating V_{off(RMS)} with a defined LCD threshold voltage (V_{th}), typically when the LCD exhibits approximately 10 % contrast.

As the programming range for the internally generated V_{LCD} allows values above the maximum allowed V_{LCD}, the user must ensure, while setting the VOP register and selecting the temperature compensation, that the V_{LCD} limit maximum of 9.0 V is never exceeded under all conditions and including all tolerances.

Table 11. Parameter values for the HV generator programming

Symbol	Value		Unit
	PRS = 0	PRS = 1	
T _{ints}	27	27	°C
a	2.94	6.75	V
b	0.03	0.03	V
programming range	2.94 to 6.75	6.75 to 10.56	V

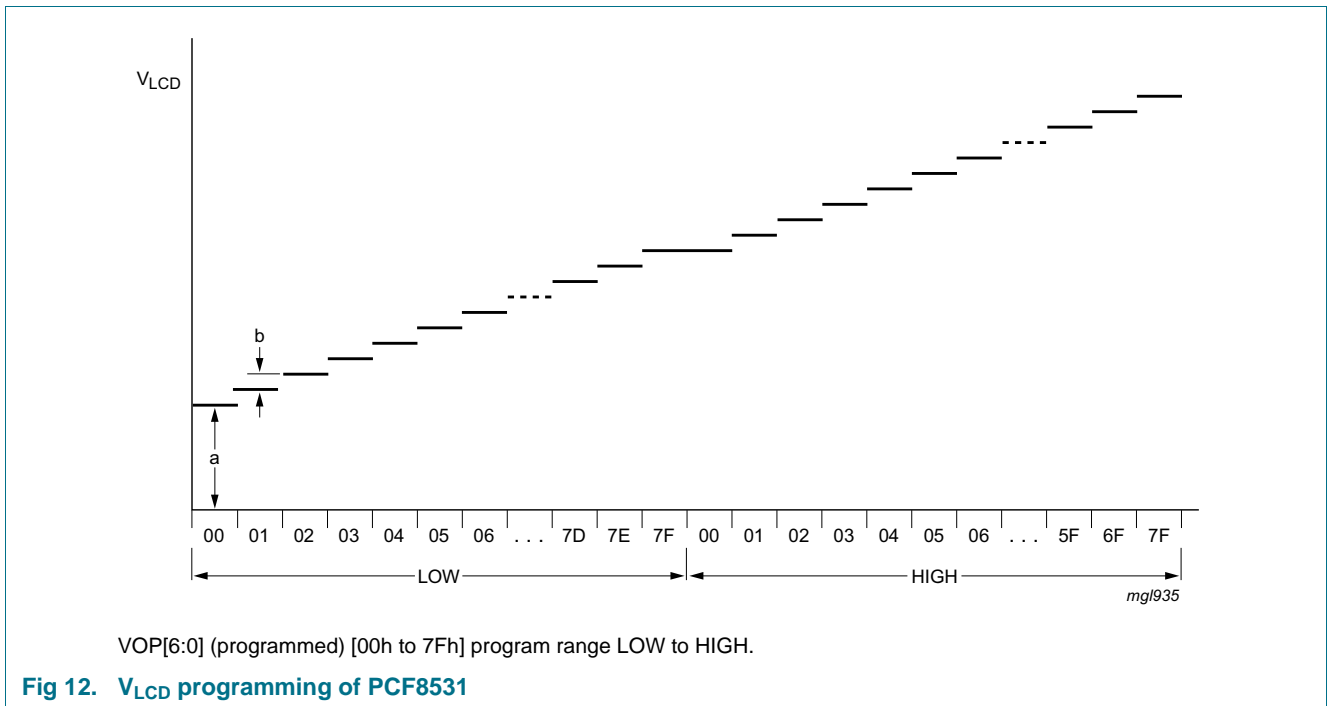

9.10 Voltage multiplier control S[1:0]

The PCF8531 incorporates a software configurable voltage multiplier. After reset (internal or external), the voltage multiplier is set to $2 \times V_{DD2}$. The voltage multiplier factors are set by setting bits S[1:0] (see [Table 14](#)).

9.11 Temperature compensation

Due to the temperature dependency of the viscosity of the liquid crystals, the LCD controlling voltage V_{LCD} should usually be increased at lower temperatures to maintain optimum contrast. [Figure 13](#) shows V_{LCD} for high multiplex rates.

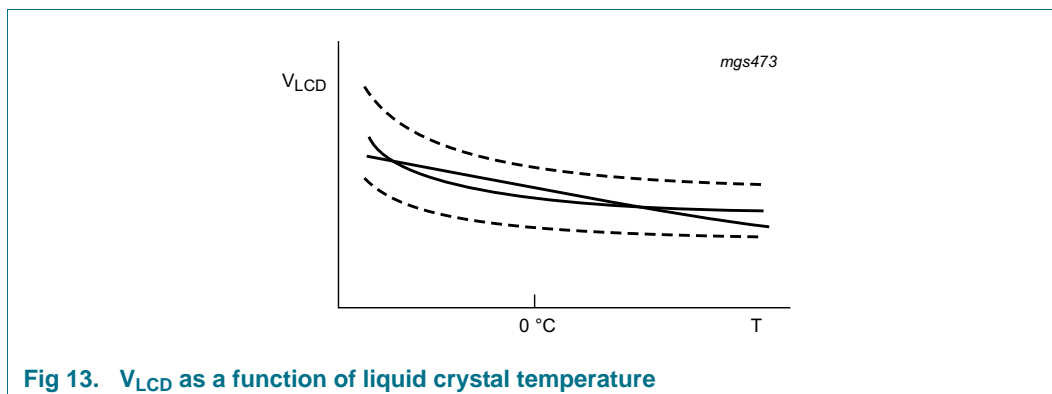

Fig 13. V_{LCD} as a function of liquid crystal temperature

Linear temperature compensation is supported in the PCF8531. The temperature coefficient of V_{LCD} can be selected from eight values by setting bits TC[2:0] (see [Table 14](#)).

Table 12. Instruction set

Instruction	I ² C-bus command ^[1]		I ² C-bus command byte								Description
	RS	R/W	DB7	DB6	DB5	DB4	DB3	DB2	DB1	DB0	
H1 and H0 = don't care (H independent command page)											
NOP	0	0	0	0	0	0	0	0	0	0	no operation
write data	1	0	D7	D6	D5	D4	D3	D2	D1	D0	write data to display RAM
set default H[1:0]	0	0	0	0	0	0	0	0	0	1	select H[1:0] = 0
H1 = 0 and H0 = 0 (function and RAM command page)											
instruction set	0	0	0	0	0	0	1	0	H1	H0	select command page
function set	0	0	0	0	1	0	0	PD	V	0	power-down control; entry mode
set Y address of RAM	0	0	0	1	0	0	0	Y2	Y1	Y0	set Y address of RAM; $0 \leq Y \leq 5$
set X address of RAM	0	0	1	X6	X5	X4	X3	X2	X1	X0	set X address of RAM; $0 \leq X \leq 127$
H1 = 0 and H0 = 1 (display setting command page)											
multiplex rate	0	0	0	0	0	0	0	1	M1	M0	set multiplex rate
display control	0	0	0	0	0	0	1	D	IM	E	set display configuration
bias system	0	0	0	0	0	1	0	BS2	BS1	BS0	set bias system (BSx)
H1 = 1 and H0 = 0 (HV-gen command page)											
HV-gen control	0	0	0	0	0	0	0	1	PRS	HVE	set V_{LCD} programming range
HV-gen configuration	0	0	0	0	0	0	1	0	S1	S0	set voltage multiplication factor

Table 12. Instruction set ...continued

Instruction	I ² C-bus command ^[1]		I ² C-bus command byte								Description
	RS	R/W	DB7	DB6	DB5	DB4	DB3	DB2	DB1	DB0	
temperature control	0	0	0	0	1	0	0	TC2	TC1	TC0	set temperature coefficient
test modes	0	0	0	1	X	X	X	X	X	X	do not use (reserved for test)
V _{LCD} control	0	0	1	VOP6	VOP5	VOP4	VOP3	VOP2	VOP1	VOP0	set V _{LCD} register

[1] R/W is set to the slave address byte; Co and RS are set in the control byte.

Table 13. Explanation for symbols in Table 12

Bit	0	1
PD	chip is active	chip is in power-down mode
V	horizontal addressing	vertical addressing
IM	normal mode; full display + icons	icon mode; only icons are displayed
H[1:0]	^[1] see Table 14	
D and E	see Table 14	
HVE	voltage multiplier disabled	voltage multiplier enabled
PRS	V _{LCD} programming range LOW	V _{LCD} programming range HIGH
TC[2:0]	see Table 14	
S[1:0]	see Table 14	

[1] The bits H[1:0] identify the command page (use set default H[1:0] command to set H[1:0] = 0).

Table 14. Description of bits H, D and E, TC and S

Bits	Value	Description
Command page (H)		
H[1:0]	00	function and RAM command page
	01	display setting command page
	10	HV-gen command page
Display modes (D, E)		
D and E	00	display blank
	10	normal mode
	01	all display segments
	11	inverse video mode

Table 14. Description of bits H, D and E, TC and S ...continued

Bits	Value	Description
Temperature coefficient (TC)		
TC[2:0]	000	temperature coefficient TC ₀
	001	temperature coefficient TC ₁
	010	temperature coefficient TC ₂
	011	temperature coefficient TC ₃
	100	temperature coefficient TC ₄
	101	temperature coefficient TC ₅
	110	temperature coefficient TC ₆
	111	temperature coefficient TC ₇
Voltage multiplier factor (S)		
S[1:0]	00	2 × voltage multiplier
	01	3 × voltage multiplier
	10	4 × voltage multiplier
	11	5 × voltage multiplier

10. I²C-bus interface

10.1 Characteristics of the I²C-bus

The I²C-bus is for bidirectional, two-line communication between different ICs or modules. The two lines are a Serial Data line (SDA) and a Serial Clock line (SCL). Both lines must be connected to a positive supply via a pull-up resistor. Data transfer may be initiated only when the bus is not busy.

10.1.1 Bit transfer

One data bit is transferred during each clock pulse. The data on the SDA line must remain stable during the HIGH period of the clock pulse as changes in the data line at this time will be interpreted as a control signal (see [Figure 14](#)).

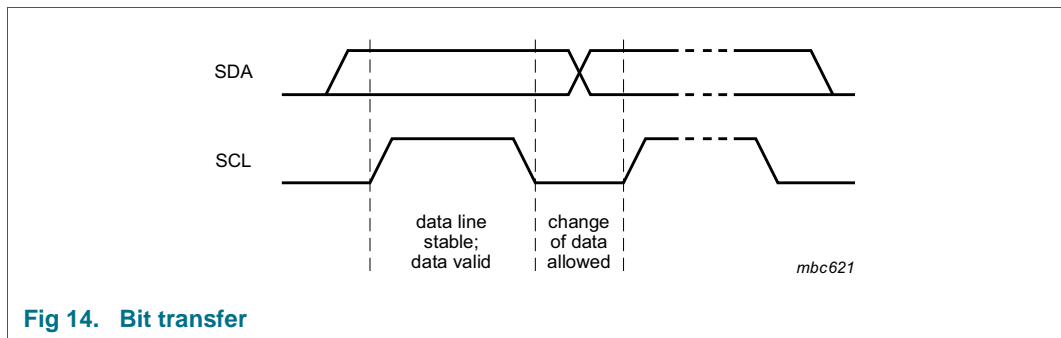

Fig 14. Bit transfer

10.1.2 START and STOP conditions

Both data and clock lines remain HIGH when the bus is not busy. A HIGH-to-LOW transition of the data line, while the clock is HIGH is defined as the START condition (S). A LOW-to-HIGH transition of the data line while the clock is HIGH is defined as the STOP condition (P). The START and STOP conditions are shown in [Figure 15](#).

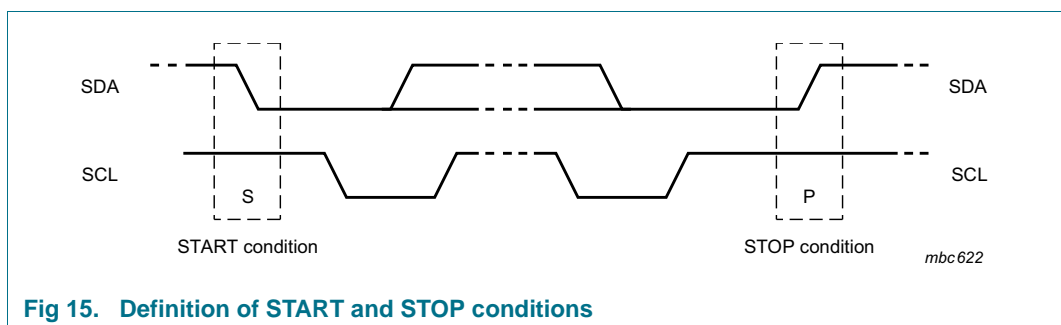

Fig 15. Definition of START and STOP conditions

10.1.3 System configuration

The system configuration is shown in [Figure 16](#).

- Transmitter: the device that sends the data to the bus
- Receiver: the device that receives the data from the bus
- Master: the device that initiates a transfer, generates clock signals and terminates a transfer
- Slave: the device addressed by a master

- Multi-master: more than one master can attempt to control the bus at the same time without corrupting the message
- Arbitration: procedure to ensure that, if more than one master simultaneously tries to control the bus, only one is allowed to do so and the message is not corrupted
- Synchronization: procedure to synchronize the clock signals of two or more devices.

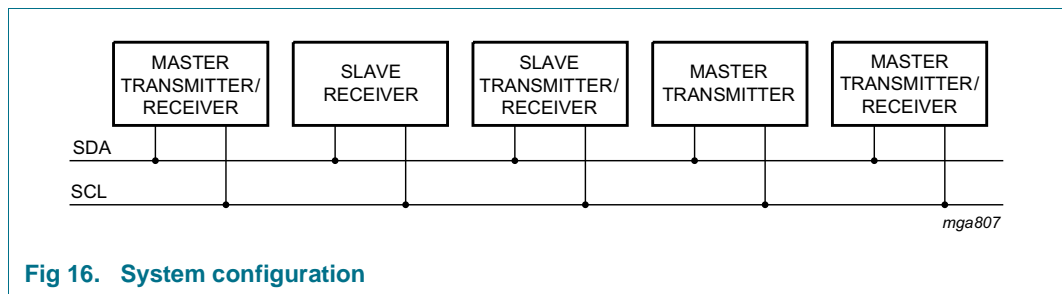

Fig 16. System configuration

10.1.4 Acknowledge

The number of data bytes transferred between the START and STOP conditions from transmitter to receiver is unlimited. Each byte of eight bits is followed by an acknowledge cycle.

- A slave receiver which is addressed must generate an acknowledge after the reception of each byte.
- Also a master receiver must generate an acknowledge after the reception of each byte that has been clocked out of the slave transmitter.
- The device that acknowledges must pull-down the SDA line during the acknowledge clock pulse, so that the SDA line is stable LOW during the HIGH period of the acknowledge related clock pulse (set-up and hold times must be taken into consideration).
- A master receiver must signal an end of data to the transmitter by not generating an acknowledge on the last byte that has been clocked out of the slave. In this event the transmitter must leave the data line HIGH to enable the master to generate a STOP condition.

Acknowledgement on the I²C-bus is shown in [Figure 17](#).

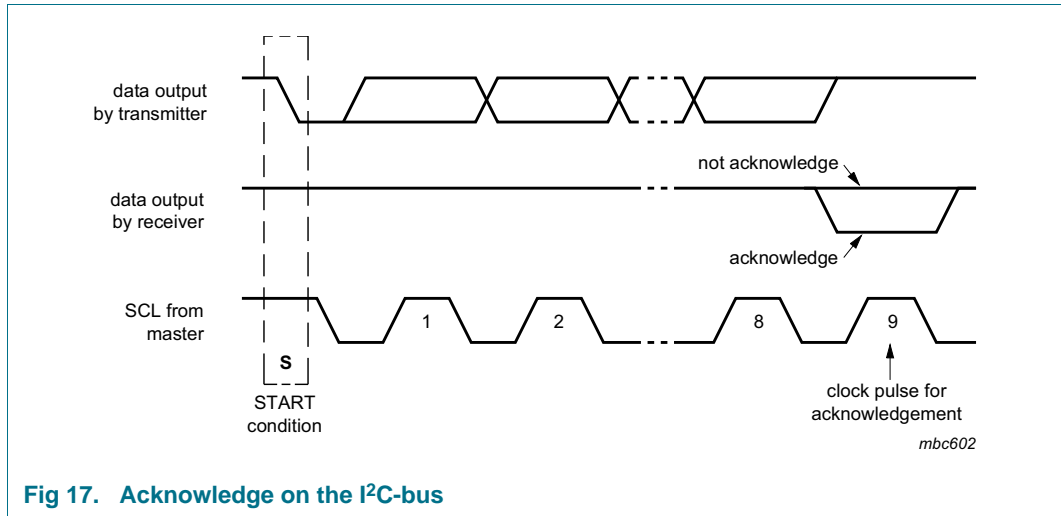

Fig 17. Acknowledge on the I²C-bus

10.2 I²C-bus protocol

This driver does not support read. The PCF8531 is a slave receiver. Therefore, it only responds when R/W = 0 in the slave address byte.

Before any data is transmitted on the I²C-bus, the device that must respond is addressed first. Two 7-bit slave addresses (0111100 and 0111101) are reserved for the PCF8531. The least significant bit of the slave address is set by connecting the input SA0 to either logic 0 (V_{SS}) or logic 1 (V_{DD}).

The I²C-bus protocol is shown in [Figure 18](#).

The sequence is initiated with a START condition (S) from the I²C-bus master, and is followed by the slave address. All slaves with the corresponding address acknowledge in parallel, all others ignore the I²C-bus transfer. After acknowledgement, one or more command words follow, which define the status of the addressed slaves. A command word consists of a control byte, which defines Co and RS, plus a data byte (see [Figure 19](#) and [Table 12](#)).

The last control byte is tagged with a cleared most significant bit, the continuation bit Co. The control and data bytes are also acknowledged by all addressed slaves on the bus.

After the last control byte, depending on the RS bit setting, either a series of display data bytes or command data bytes may follow. If the RS bit was set logic 1, these display bytes are stored in the display RAM at the address specified by the data pointer.

The data pointer is automatically updated and the data is directed to the intended PCF8531 device. If the RS bit of the last control byte was set logic 0, these command bytes will be decoded and the setting of the device will be changed according to the received commands. The acknowledgement after each byte is made only by the addressed PCF8531. At the end of the transmission, the I²C-bus master issues a STOP condition (P).

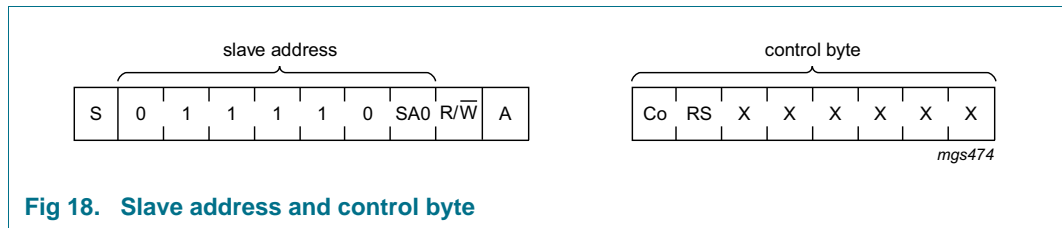

Fig 18. Slave address and control byte

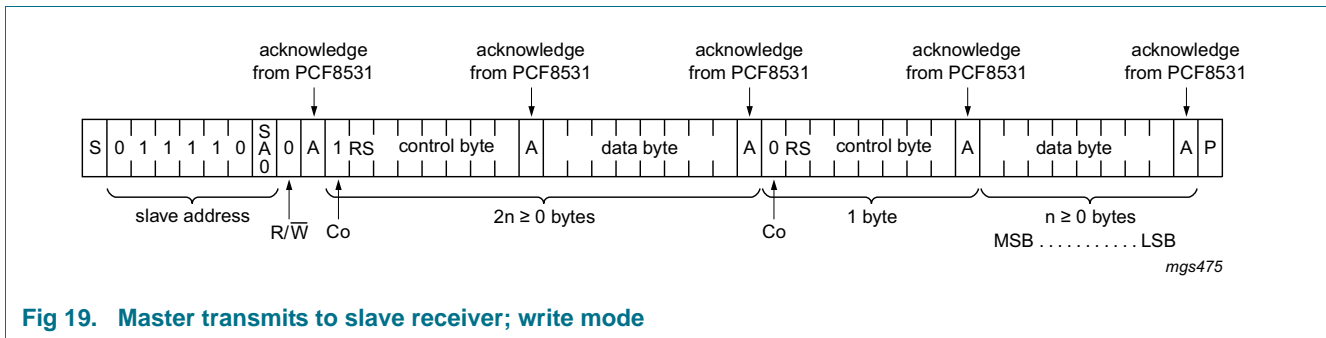

Fig 19. Master transmits to slave receiver; write mode

10.3 Command decoder

The command decoder identifies command words that arrive on the I²C-bus. The most significant bit of a control byte is the continuation bit Co. If this bit is logic 1, it indicates that only one data byte (either command or RAM data) will follow. If this bit is logic 0, it indicates that a series of data bytes (either command or RAM data) may follow. The DB6 bit of a control byte is the RAM data/command bit RS. When this bit is logic 1, it indicates that another RAM data byte will be transferred next. If the bit is logic 0, it indicates that another command byte will be transferred next.

- Pairs of bytes; information in the second byte, the first byte determines whether information is display or instruction data
- Stream of information bytes after Co = 0; display or instruction data, depending on last RS.

11. Internal circuitry

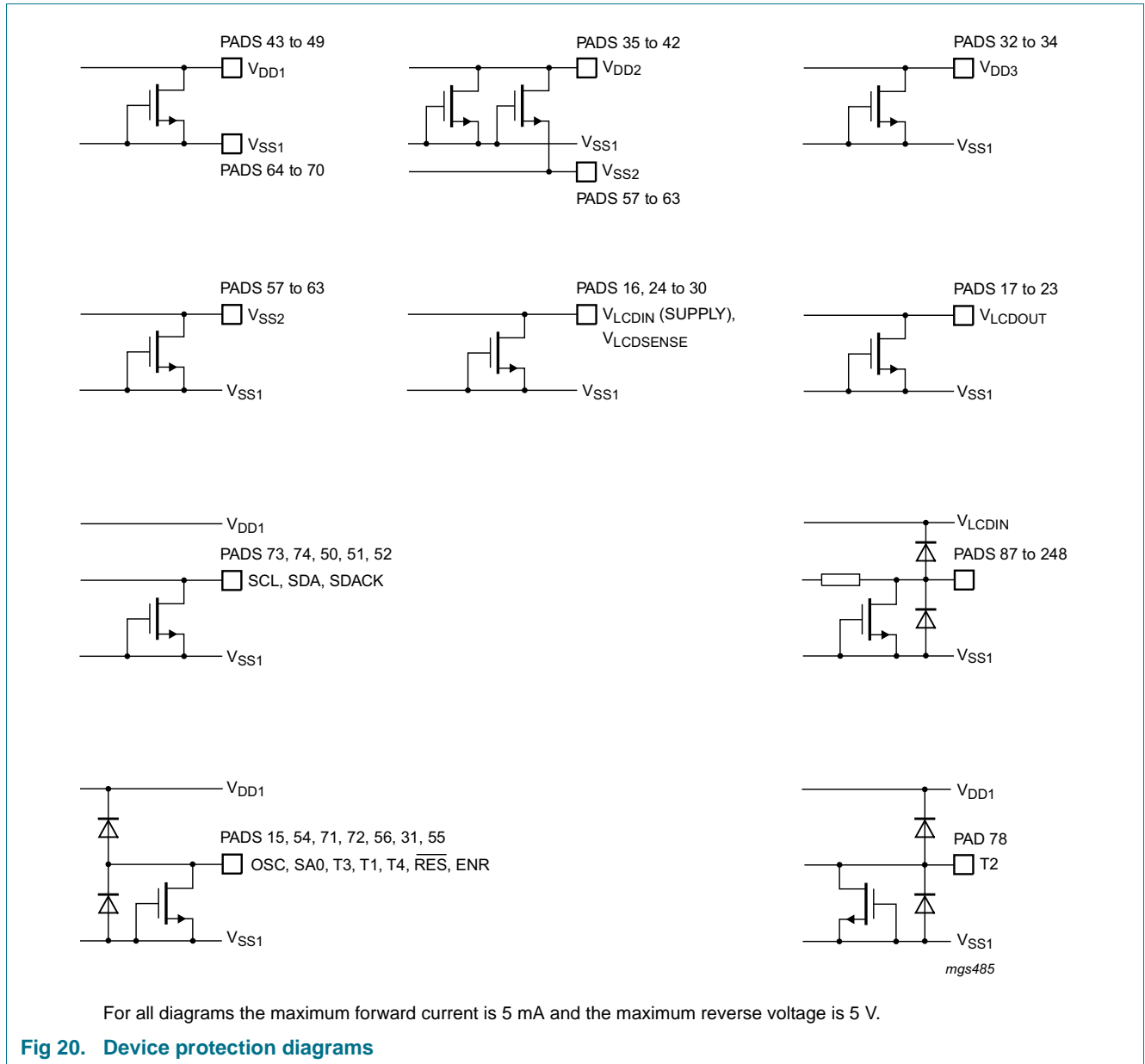

12. Safety notes

CAUTION



This device is sensitive to ElectroStatic Discharge (ESD). Observe precautions for handling electrostatic sensitive devices.

Such precautions are described in the *ANSI/ESD S20.20*, *IEC/ST 61340-5*, *JESD625-A* or equivalent standards.

CAUTION



Static voltages across the liquid crystal display can build up when the LCD supply voltage (V_{LCD}) is on while the IC supply voltage (V_{DD}) is off, or vice versa. This may cause unwanted display artifacts. To avoid such artifacts, V_{LCD} and V_{DD} must be applied or removed together.

CAUTION



Semiconductors are light sensitive. Exposure to light sources can cause the IC to malfunction. The IC must be protected against light. The protection must be applied to all sides of the IC.

13. Limiting values

Table 15. Limiting values [\[1\]](#)

In accordance with the Absolute Maximum Rating System (IEC 60134).

Symbol	Parameter	Conditions	Min	Max	Unit
V _{DD1}	supply voltage 1	logic supply	-0.5	+6.5	V
V _{DD2}	supply voltage 2	multiplier supply	-0.5	+6.5	V
V _{DD3}	supply voltage 3	multiplier supply	-0.5	+6.5	V
V _{LCD}	LCD supply voltage		-0.5	+10.0	V
V _I	input voltage		-0.5	V _{DD} + 0.5	V
V _O	output voltage		-0.5	V _{DD} + 0.5	V
I _{DD}	supply current		-50	+50	mA
I _{DD(LCD)}	LCD supply current		-50	+50	mA
I _{SS}	ground supply current		-50	+50	mA
I _I	input current		-10	+10	mA
I _O	output current		-10	+10	mA
P _{tot}	total power dissipation		-	300	mW
P/out	power dissipation per output		-	30	mW
V _{ESD}	electrostatic discharge voltage	HBM [2]	-	±1500	V
		MM [3]	-	±200	V
I _{Iu}	latch-up current		[4]	200	mA
T _j	junction temperature		-	+150	°C
T _{stg}	storage temperature		[5]	+150	°C
T _{amb}	ambient temperature	operating device	-40	+85	°C

- [1] Parameters are valid over the whole operating temperature range unless otherwise specified. All voltages are referenced to V_{SS} unless otherwise specified.
- [2] Pass level; Human Body Model (HBM), according to [Ref. 7 "JESD22-A114"](#).
- [3] Pass level; Machine Model (MM), according to [Ref. 8 "JESD22-A115"](#).
- [4] Pass level; latch-up testing according to [Ref. 9 "JESD78"](#) at maximum ambient temperature (T_{amb(max)}).
- [5] According to the store and transport requirements (see [Ref. 11 "UM10569"](#)) the devices have to be stored at a temperature of +8 °C to +45 °C and a humidity of 25 % to 75 %.

14. Static characteristics

Table 16. Static characteristics

$V_{DD1} = 1.8\text{ V (1.9 V) to } 5.5\text{ V}$; V_{DD2} and $V_{DD3} = 2.5\text{ V to } 4.5\text{ V}$; $V_{SS1} = V_{SS2} = 0\text{ V}$; V_{DD1} to $V_{DD3} \leq V_{LCD} \leq 9.0\text{ V}$;
 $T_{amb} = -40\text{ }^{\circ}\text{C to } +85\text{ }^{\circ}\text{C}$; unless otherwise specified.

Symbol	Parameter	Conditions	Min	Typ	Max	Unit
Supplies						
V_{LCD}	LCD supply voltage		[1] 4.0	-	9.0	V
		icon mode	[1] 3.0	-	9.0	V
V_{DD1}	supply voltage 1	logic supply	1.9	-	5.5	V
		$T_{amb} \geq -25\text{ }^{\circ}\text{C}$	1.8	-	5.5	V
V_{DD2}	supply voltage 2	multiplier supply; LCD voltage internally generated	2.5	-	5.5	V
V_{DD3}	supply voltage 3	multiplier supply; LCD voltage internally generated	2.5	-	5.5	V
I_{DD}	supply current	power-down mode; internal V_{LCD}	-	2	10	μA
		normal mode; internal V_{LCD}	[2][3] -	170	350	μA
		normal mode; external V_{LCD}	[2] -	10	50	μA
$I_{DD(LCD)}$	LCD supply current	normal mode; external V_{LCD}	[2][4] -	25	100	μA
		icon mode; external V_{LCD}	[2][5] -	15	70	μA
V_{POR}	power-on reset voltage		[6] 0.9	1.2	1.6	V
Logic						
V_{IL}	LOW-level input voltage		V_{SS}	-	$0.3V_{DD}$	V
V_{IH}	HIGH-level input voltage		$0.7V_{DD}$	-	V_{DD}	V
$I_{OL(SDA)}$	LOW-level output current on pin SDA	$V_{OL} = 0.4\text{ V}$; $V_{DD} = 5.0\text{ V}$	3.0	-	-	mA
I_{LI}	input leakage current	$V_I = V_{DD}$ or V_{SS}	-1	-	+1	μA
Column and row outputs						
R_O	output resistance	column outputs: C0 to C127	[7] -	12	20	$\text{k}\Omega$
		row outputs: R0 to R33	-	12	20	$\text{k}\Omega$
ΔV_{bias}	bias voltage variation	outputs R0 to R33 and C0 to C127	-100	0	+100	mV
ΔV_{LCD}	LCD voltage variation	TC ₁ to TC ₇	[8] -	-	± 3.9	%
TC	temperature coefficient	$T_{amb} = -20\text{ }^{\circ}\text{C to } +70\text{ }^{\circ}\text{C}$				
		TC ₀ ; TC[2:0] = 000	-	0	-	%/K
		TC ₁ ; TC[2:0] = 001	-	-0.026	-	%/K
		TC ₂ ; TC[2:0] = 010	-	-0.039	-	%/K
		TC ₃ ; TC[2:0] = 011	-	-0.052	-	%/K
		TC ₄ ; TC[2:0] = 100	-	-0.078	-	%/K
		TC ₅ ; TC[2:0] = 101	-	-0.13	-	%/K
		TC ₆ ; TC[2:0] = 110	-	-0.19	-	%/K
T_{ints}	intersection temperature		-	27	-	$^{\circ}\text{C}$

- [1] As the programming range for the internally generated V_{LCD} allows values above the maximum allowed V_{LCD} , the user must ensure, while setting the VOP register and selecting the temperature compensation, that the V_{LCD} maximum limit of 9 V will never be exceeded under all conditions and including all tolerances.
- [2] LCD outputs are open circuit, inputs at V_{DD} or V_{SS} ; bus inactive.
- [3] V_{DD1} to $V_{DD3} = 2.85$ V; $V_{LCD} = 7.0$ V; voltage multiplier = $3 \times V_{DD}$; $f_{osc} = 34$ kHz.
- [4] V_{DD1} to $V_{DD3} = 2.75$ V; $V_{LCD} = 9.0$ V; $f_{osc} = 34$ kHz.
- [5] V_{DD1} to $V_{DD3} = 2.75$ V; $V_{LCD} = 3.5$ V; $f_{osc} = 34$ kHz.
- [6] Resets all logic when $V_{DD1} < V_{POR}$.
- [7] $I_{load} \leq 50$ μ A; outputs are tested one at a time.
- [8] $V_{LCD} \leq 7.7$ V.

15. Dynamic characteristics

Table 17. Dynamic characteristics

$V_{DD1} = 1.8$ V (1.9 V) to 5.5 V; V_{DD2} and $V_{DD3} = 2.5$ V to 4.5 V; $V_{SS1} = V_{SS2} = 0$ V; V_{DD1} to $V_{DD3} \leq V_{LCD} \leq 9.0$ V; $T_{amb} = -40$ °C to +85 °C; unless otherwise specified.

Symbol	Parameter	Conditions	Min	Typ	Max	Unit
$f_{fr(LCD)}$	LCD frame frequency	$V_{DD} = 3.0$ V [1]	40	66	135	Hz
f_{osc}	oscillator frequency		20	34	65	kHz
$f_{clk(ext)}$	external clock frequency		20	-	65	kHz
$t_{w(RESL)}$	RES LOW pulse width	[2]	300	-	-	ns
$t_{su(RESL)}$	RES LOW set-up time		-	-	30	μ s
Serial bus interface (see Figure 22)^[3]						
f_{SCL}	SCL clock frequency		0	-	400	kHz
t_{LOW}	LOW period of the SCL clock		1.3	-	-	μ s
t_{HIGH}	HIGH period of the SCL clock		0.6	-	-	μ s
$t_{SU,DAT}$	data set-up time		100	-	-	ns
$t_{HD,DAT}$	data hold time		0	-	0.9	μ s
t_r	rise time of both SDA and SCL signals	[4]	$20 + 0.1C_b$	-	300	ns
t_f	fall time of both SDA and SCL signals	[4]	$20 + 0.1C_b$	-	300	ns
C_b	capacitive load for each bus line		-	-	400	pF
$t_{SU,STA}$	set-up time for a repeated START condition		0.6	-	-	μ s
$t_{HD,STA}$	hold time (repeated) START condition		0.6	-	-	μ s
$t_{SU,STO}$	set-up time for STOP condition		0.6	-	-	μ s
t_{SP}	pulse width of spikes that must be suppressed by the input filter	on bus	-	-	50	ns
t_{BUF}	bus free time between a STOP and START condition		1.3	-	-	μ s

- [1] $t_{fr} = f_{clk(ext)}/480$ or $f_{osc}/480$.
- [2] A reset is generated if $t_{w(RESL)} > 3$ ns (see [Figure 21](#)).
- [3] All timing values are valid within the operating supply voltage and ambient temperature range and are referenced to V_{IL} and V_{IH} , with an input voltage swing of V_{SS} to V_{DD} .
- [4] C_b = total capacitance of one bus line in pF.

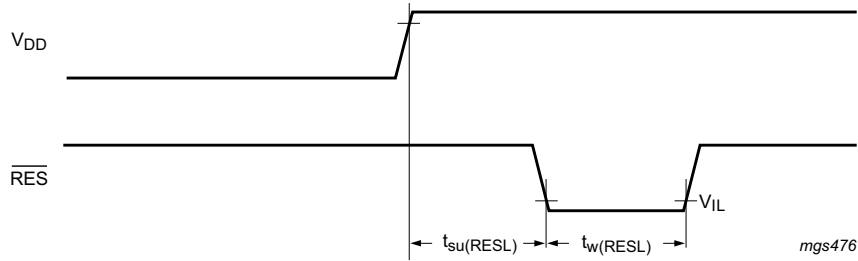

Fig 21. Reset timing

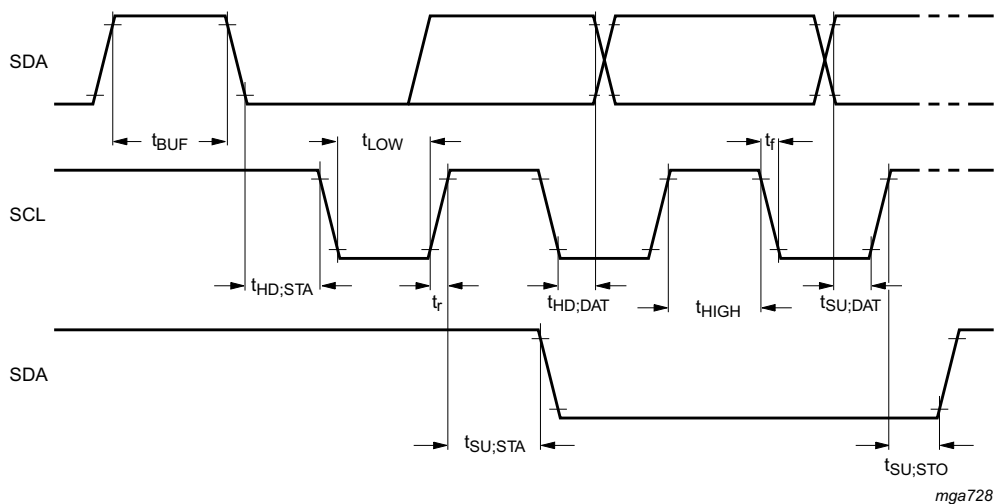
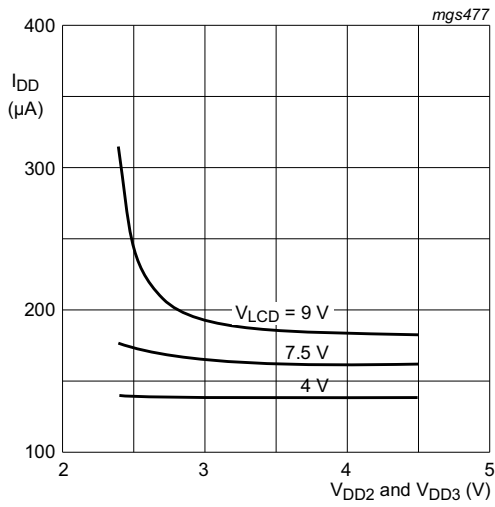
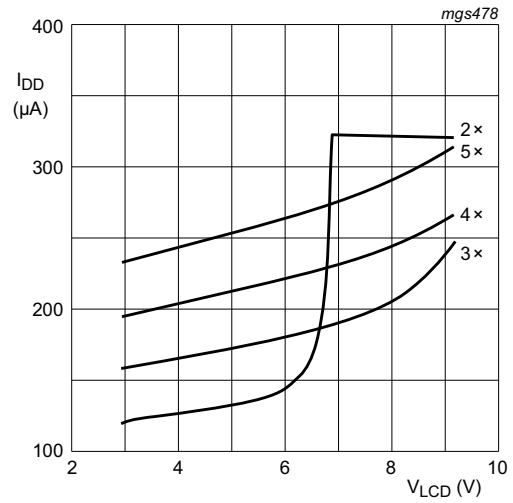

Fig 22. I²C-bus timing



$V_{DD1} = 2\text{ V}$; $4\times$ voltage multiplier; $T_{amb} = 27\text{ }^{\circ}\text{C}$; $TC = 0$; $BS = 100$; no V_{LCD} load.

Fig 23. Supply current as a function of supply voltage 2 and supply voltage 3



$V_{DD1} = 1.8\text{ V}$; V_{DD2} and $V_{DD3} = 2.6\text{ V}$; $T_{amb} = 27\text{ }^{\circ}\text{C}$; $f_{osc} = 34\text{ kHz}$; no V_{LCD} load.

Fig 24. Supply current as a function of LCD supply voltage; different multiplication factors

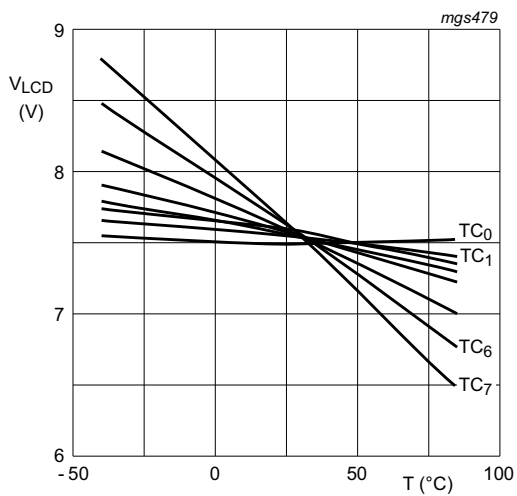

$V_{LCD} = 7.5\text{ V}$; V_{DD1} to $V_{DD3} = 2.7\text{ V}$; $T_{amb} = 27\text{ }^{\circ}\text{C}$; no V_{LCD} load.

Fig 25. LCD supply voltage as a function of temperature

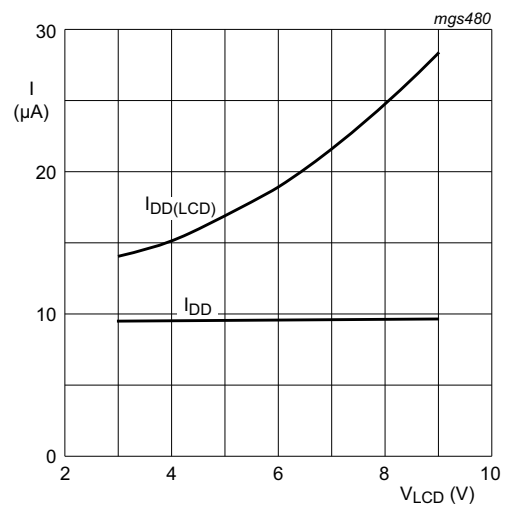

$V_{DD1} = 1.8\text{ V}$; V_{DD2} and $V_{DD3} = 2.5\text{ V}$; external V_{LCD} ; $T_{amb} = 27\text{ }^{\circ}\text{C}$; $TC = 0$; $BS = 100$; no V_{LCD} load.

Fig 26. Supply current as a function of LCD supply voltage

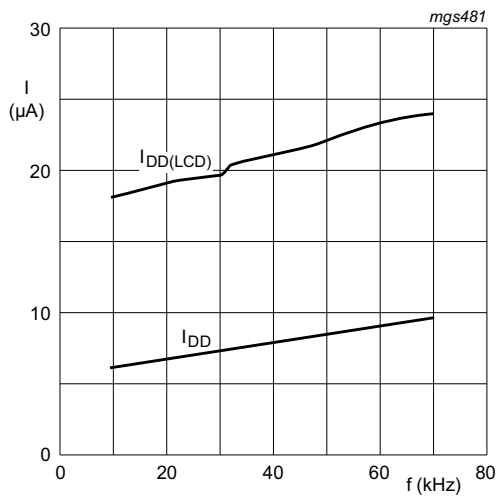

$V_{DD1} = 2.5\text{ V}$; V_{DD2} and $V_{DD3} = 2.5\text{ V}$; external V_{LCD} ;
 $T_{amb} = 27\text{ °C}$; $TC = 0$; $BS = 100$; no V_{LCD} load.

Fig 27. Supply current as a function of frequency

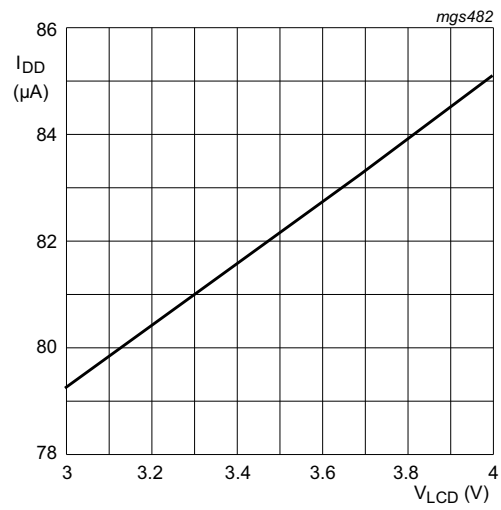

$V_{DD1} = 1.8\text{ V}$; $V_{DD2} = 2.5\text{ V}$; 2 × voltage multiplier;
 $T_{amb} = 27\text{ °C}$; $TC = 0$; $BS = 111$; no V_{LCD} load.

Fig 28. Supply current as a function of LCD supply voltage

16. Application information

16.1 Typical system configuration

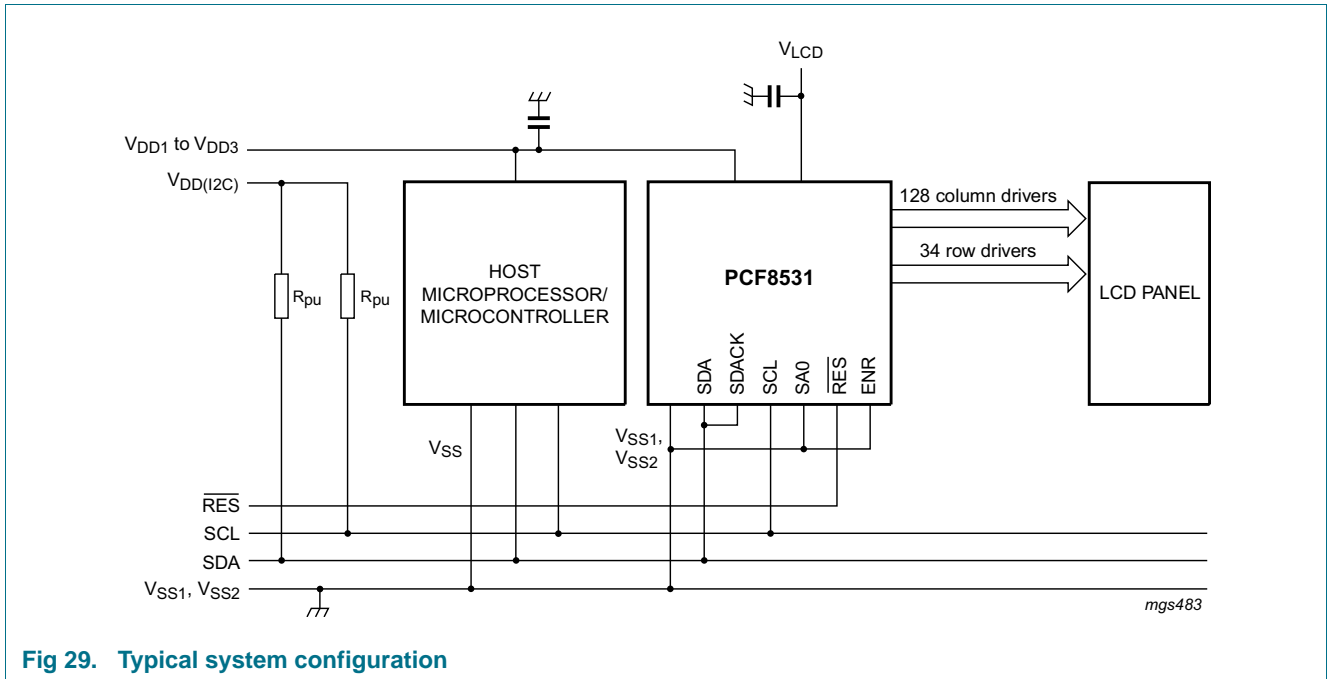

Fig 29. Typical system configuration

The host microprocessor/microcontroller and the PCF8531 are both connected to the I²C-bus. The SDA and SCL lines must be connected to the positive power supply via pull-up resistors. The internal oscillator requires no external components. The appropriate intermediate biasing voltage for the multiplexed LCD waveforms are generated on-chip. The only other connections required to complete the system are to the power supplies (V_{DD} , V_{SS} , and V_{LCD}) and suitable capacitors for decoupling V_{LCD} and V_{DD} .

16.2 Power supply connections for internal V_{LCD} generation

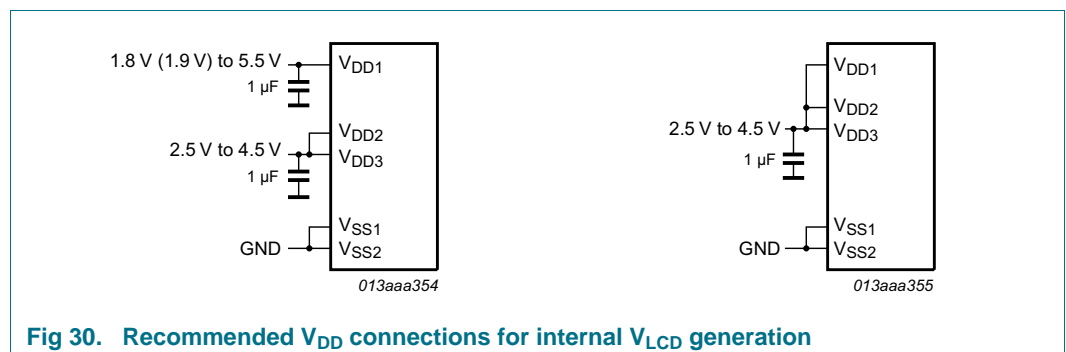

Fig 30. Recommended V_{DD} connections for internal V_{LCD} generation

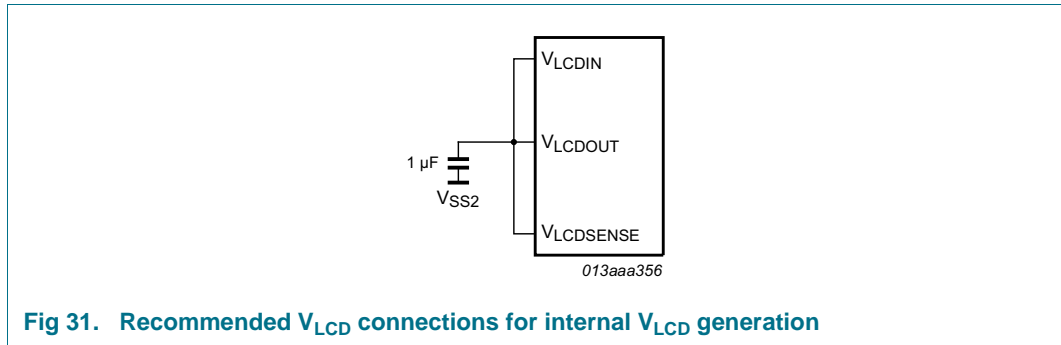
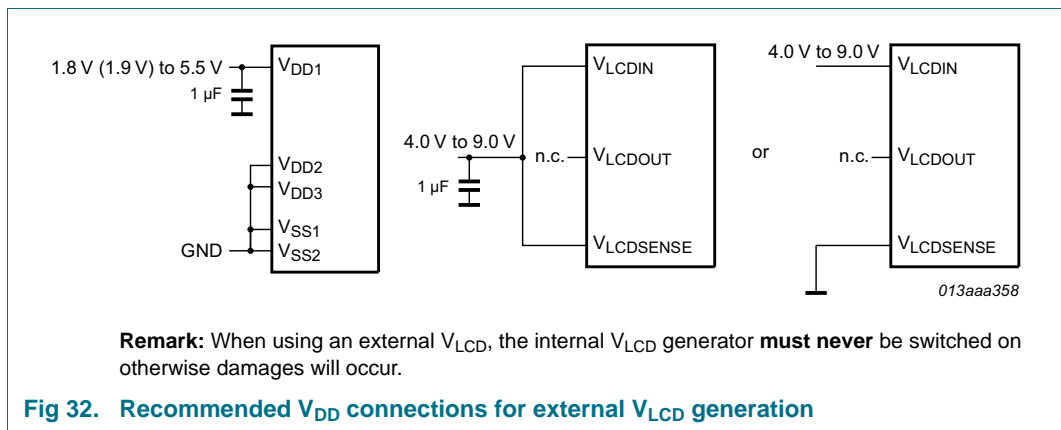

Fig 31. Recommended V_{LCD} connections for internal V_{LCD} generation

16.3 Power supply connections for external V_{LCD} generation



Remark: When using an external V_{LCD} , the internal V_{LCD} generator **must never** be switched on otherwise damages will occur.

Fig 32. Recommended V_{DD} connections for external V_{LCD} generation

16.4 Information about V_{LCD} connections

V_{LCDIN} — This input is used for generating the 5 LCD bias levels. It is the power supply for the bias level buffers.

V_{LCDOUT} — This is the V_{LCD} output if V_{LCD} is generated internally. It is the output of the charge pump. In this case pin V_{LCDOUT} must be connected to V_{LCDIN} and to $V_{LCDSENSE}$ (see [Figure 31](#)). V_{LCDOUT} must be left open circuit when V_{LCD} is supplied from an external source (see [Figure 32](#)).

$V_{LCDSENSE}$ — When using the internal V_{LCD} generation, this pin must be connected to V_{LCDOUT} and V_{LCDIN} (see [Figure 31](#)). When using an external V_{LCD} supply it must be connected to V_{LCDIN} or to ground (see [Figure 32](#)).

16.5 Chip-on-glass application

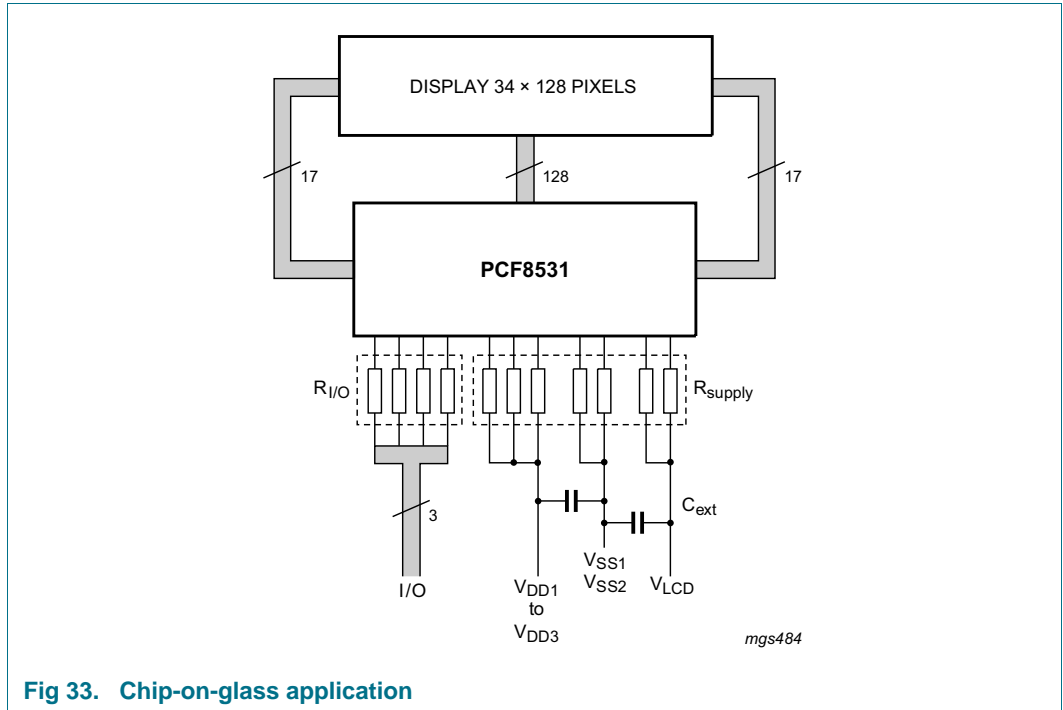

Fig 33. Chip-on-glass application

The required minimum values for the external capacitors in a chip-on-glass application are:

- $C_{ext} = 100 \text{ nF}$ between V_{LCD} and V_{SS1}, V_{SS2} ; $C_{ext} = 470 \text{ nF}$ between $V_{DD1}, V_{DD2}, V_{DD3}$ and V_{SS1}, V_{SS2} .
- Higher capacitor values are recommended for ripple reduction.
- For COG applications, the recommended ITO track resistance must be minimized for the I/O and supply connections. Optimized values for these tracks are below 50Ω for the supply (R_{supply}) and below 100Ω for the I/O connections ($R_{I/O}$).
- To reduce the sensitivity of the reset to ESD/EMC disturbances for a COG application, NXP strongly recommended implementing a series input resistance in the reset line (recommended minimum value $8 \text{ k}\Omega$) on the glass (ITO). If the reset input is not used, this input must be connected to V_{DD1} using a short connection.

16.6 Programming example

Table 18. Programming example for PCF8531

Step	Serial bus byte								Display	Operation
	DB7	DB6	DB5	DB4	DB3	DB2	DB1	DB0		
1	0	1	1	1	1	0	SA0	0		start; slave address; $R/\overline{W} = 0$
2	1	0	0	0	0	0	0	0		control byte; Co = 1; RS = 0
3	0	0	0	0	0	0	0	1		H[1:0] independent command; select function and RAM command page (H[1:0] = 00)
4	1	0	0	0	0	0	0	0		control byte; Co = 1; RS = 0
5	0	0	1	0	0	0	1	0		function and RAM command page PD = 0 and V = 1
6	1	0	0	0	0	0	0	0		control byte; Co = 1; RS = 0
7	0	0	0	0	1	0	0	1		function and RAM command page select display setting command page H[1:0] = 01
8	1	0	0	0	0	0	0	0		control byte; Co = 1; RS = 0
9	0	0	0	0	1	1	0	0		display setting command page; set normal mode (D = 1; IM = 0 and E = 0)
10	1	0	0	0	0	0	0	0		control byte; Co = 1; RS = 0
11	0	0	0	0	0	1	0	1		select multiplex rate 1:34
12	1	0	0	0	0	0	0	0		control byte; Co = 1; RS = 0
13	0	0	0	0	0	0	0	1		H[2:0] independent command; select function and RAM command page H[1:0] = 00
14	1	0	0	0	0	0	0	0		control byte; Co = 1; RS = 0
15	0	0	0	0	1	0	1	0		function and RAM command page; select HV-gen command page H[1:0] = 10
16	1	0	0	0	0	0	0	0		control byte; Co = 1; RS = 0
17	0	0	0	0	1	0	1	1		HV-gen command page; select voltage multiplication factor 5 S[1:0] = 11
18	1	0	0	0	0	0	0	0		control byte; Co = 1; RS = 0
19	0	0	1	0	0	0	1	0		HV-gen command page; select temperature coefficient 2 TC[2:0] = 010
20	1	0	0	0	0	0	0	0		control byte; Co = 1; RS = 0
21	0	0	0	0	0	1	1	1		HV-gen command page; select high V_{LCD} programming range (PRS = 1); voltage multiplier off (HVE = 1)
22	1	0	0	0	0	0	0	0		control byte; Co = 1; RS = 0

Table 18. Programming example for PCF8531 ...continued







Step	Serial bus byte								Display	Operation
	DB7	DB6	DB5	DB4	DB3	DB2	DB1	DB0		
23	1	0	1	0	0	0	0	0		HV-gen command page; set $V_{LCD} = 7.71\text{ V}$; $VOP[6:0] = 0100000$
24	0	1	0	0	0	0	0	0		control byte; $Co = 0$; $RS = 1$
25	0	0	0	1	1	1	1	1	 <i>mgs405</i>	data write; Y and X are initialized to 0 by default, so they are not set here
26	0	0	0	0	0	1	0	1	 <i>mgs406</i>	data write
27	0	0	0	0	0	1	1	1	 <i>mgs407</i>	data write
28	0	0	0	0	0	0	0	0	 <i>mgs407</i>	data write
29	0	0	0	1	1	1	1	1	 <i>mgs409</i>	data write
30	0	0	0	0	0	1	0	0	 <i>mgs410</i>	data write
31	0	0	0	1	1	1	1	1	 <i>mgs411</i>	data write; last data and stop transmission
32	0	1	1	1	1	0	SA0	0	 <i>mgs411</i>	repeated start; slave address; $R/\bar{W} = 0$

Table 18. Programming example for PCF8531 ...continued

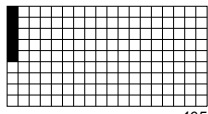
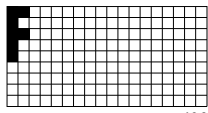
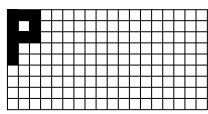
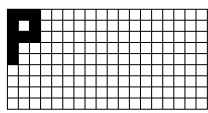
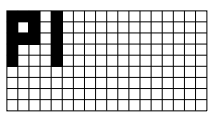
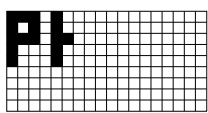
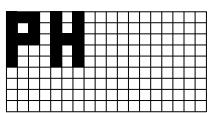
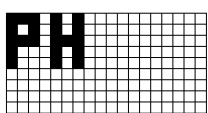
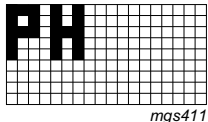
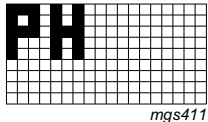
Step	Serial bus byte								Display	Operation
	DB7	DB6	DB5	DB4	DB3	DB2	DB1	DB0		
33	1	0	0	0	0	0	0	0		control byte; Co = 1; RS = 0
34	0	0	0	0	0	0	0	1		H[1:0] independent command; select function and RAM command page H[1:0] = 00
35	1	0	0	0	0	0	0	0		control byte; Co = 1; RS = 0
36	0	0	0	0	1	0	0	1		function and RAM command page; select display setting command page H[1:0] = 01
37	1	0	0	0	0	0	0	0		control byte; Co = 1; RS = 0
38	0	0	0	0	0	0	0	1		H[1:0] independent command; select function and RAM command page H[1:0] = 00
39	1	0	0	0	0	0	0	0		control byte; Co = 1; RS = 0
40	0	0	0	0	1	1	0	1		display control; set inverse video mode (D = 1; E = 1 and IM = 0)
41	1	0	0	0	0	0	0	0		control byte; Co = 1; RS = 0
42	1	0	0	0	0	0	0	0		set X address of RAM; set address to '0000000'
43	0	1	0	0	0	0	0	0		control byte; Co = 0; RS = 1
44	0	0	0	0	0	0	0	0		data write

17. Package outline

Not applicable.

18. Handling information

All input and output pins are protected against ElectroStatic Discharge (ESD) under normal handling. When handling Metal-Oxide Semiconductor (MOS) devices ensure that all normal precautions are taken as described in *JESD625-A*, *IEC 61340-5* or equivalent standards.

19. Packing information

Table 19. Tray dimensions (see [Figure 34](#))

Symbol	Description	Value
A	pocket pitch in x direction	13.72 mm
B	pocket pitch in y direction	4.17 mm
C	pocket width in x direction	12.34 mm
D	pocket width in y direction	2.05 mm
E	tray width in x direction	50.8 mm
F	tray width in y direction	50.8 mm
x	number of pockets, x direction	3
y	number of pockets, y direction	10

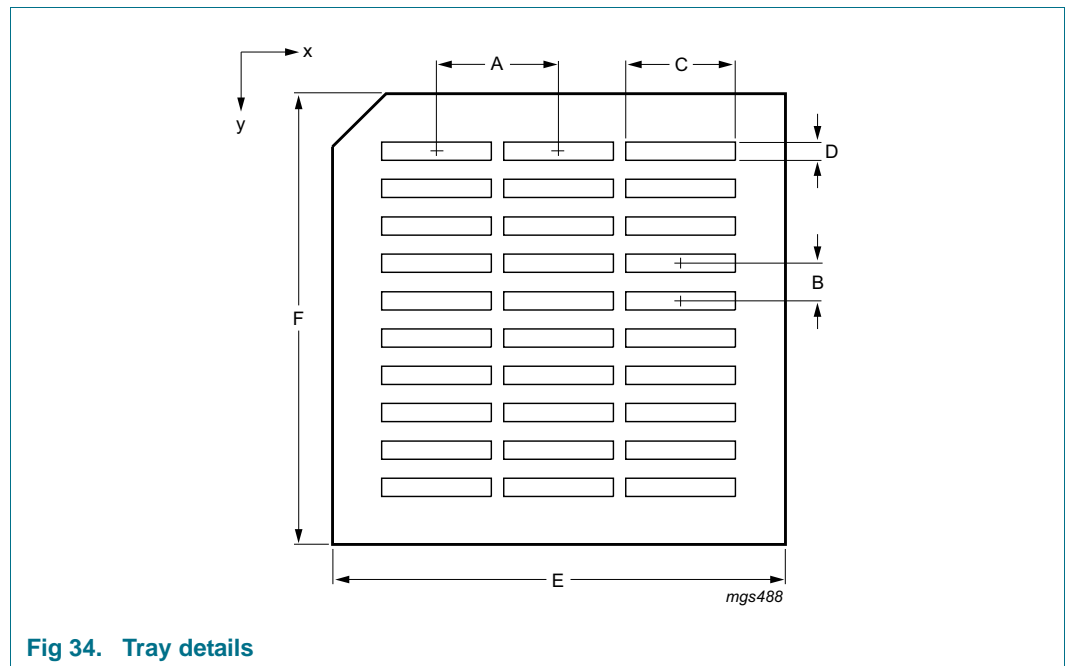
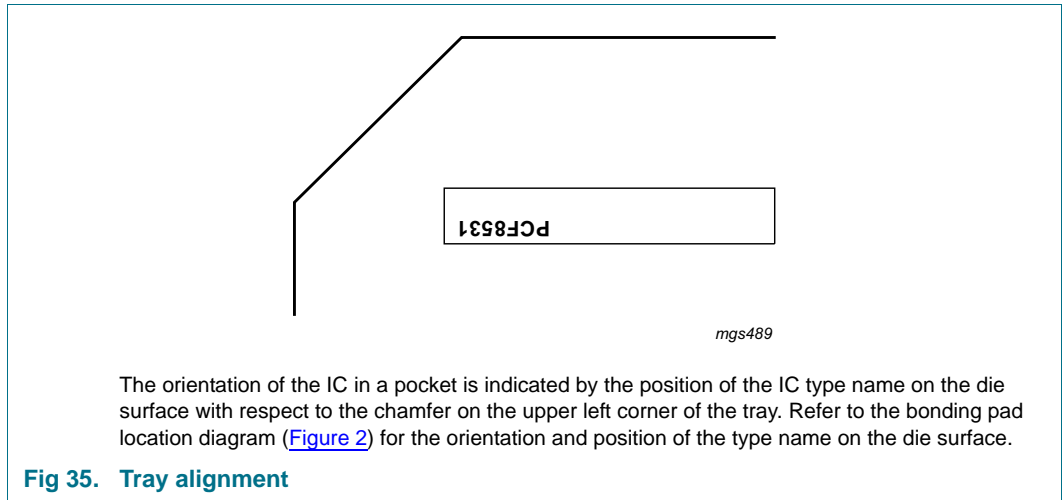

Fig 34. Tray details



20. Appendix

20.1 LCD graphic driver selection

Table 20. Selection of LCD graphic drivers

Type name	Max display resolution rows × col.	Multiplex rates	V _{DD1} (V)	V _{DD2} (V)	V _{LCD} (V)	f _{fr} (Hz)	V _{LCD} (V) charge pump	V _{LCD} (V) temperature compensat.	T _{amb} (°C)	Interface	Package	AEC-Q100
PCA8539DUG	18 × 100	1:12, 1:18	2.5 to 5.5	2.5 to 5.5	4 to 16	45 to 360 ^[1]	Y	Y	−40 to 105	I ² C, SPI	bare die	Y
PCF8539DUG	18 × 100	1:12, 1:18	2.5 to 5.5	2.5 to 5.5	4 to 16	45 to 360 ^[1]	Y	Y	−40 to 85	I ² C, SPI	bare die	N
PCF8531U	34 × 128 or 33 × 128 plus 128 icons	1:17, 1:26, 1:34	1.8 to 5.5	2.5 to 4.5	4 to 9	66	Y	Y	−40 to 85	I ² C	bare die	N
PCF8811U	80 × 128 or 79 × 129 plus 128 icons	1:16 to 1:80 in steps of 8	2 to 3.3	1.8 to 3.3	3 to 9	30 to 60 ^[1]	Y	Y	−40 to 85	I ² C, SPI, parallel	bare die	N

[1] Can be selected by command.

21. Abbreviations

Table 21. Abbreviations

Acronym	Description
CDM	Charged Device Model
CMOS	Complementary Metal-Oxide Semiconductor
COG	Chip-On-Glass
DDRAM	Double Data Random Access Memory
EMC	ElectroMagnetic Compatibility
ESD	ElectroStatic Discharge
HBM	Human Body Model
HV	High Voltage
IC	Integrated Circuit
ITO	Indium Tin Oxide
LCD	Liquid Crystal Display
LSB	Least Significant Bit
MM	Machine Model
MPU	MicroProcessor Unit
POR	Power-On Reset
RAM	Random Access Memory
RC	Resistance-Capacitance
TC	Temperature Coefficient
SCL	Serial CLock line
SDA	Serial DATa line

22. References

- [1] **AN10170** — Design guidelines for COG modules with NXP monochrome LCD drivers
- [2] **AN10706** — Handling bare die
- [3] **AN10853** — ESD and EMC sensitivity of IC
- [4] **AN11267** — EMC and system level ESD design guidelines for LCD drivers
- [5] **IEC 60134** — Rating systems for electronic tubes and valves and analogous semiconductor devices
- [6] **IEC 61340-5** — Protection of electronic devices from electrostatic phenomena
- [7] **JESD22-A114** — Electrostatic Discharge (ESD) Sensitivity Testing Human Body Model (HBM)
- [8] **JESD22-A115** — Electrostatic Discharge (ESD) Sensitivity Testing Machine Model (MM)
- [9] **JESD78** — IC Latch-Up Test
- [10] **JESD625-A** — Requirements for Handling Electrostatic-Discharge-Sensitive (ESDS) Devices
- [11] **UM10569** — Store and transport requirements
- [12] **UM10204** — I²C-bus specification and user manual

23. Revision history

Table 22. Revision history

Document ID	Release date	Data sheet status	Change notice	Supersedes
PCF8531 v.8	20140912	Product data sheet	-	PCF8531 v.7
Modifications:	<ul style="list-style-type: none"> • The format of this data sheet has been redesigned to comply with the new identity guidelines of NXP Semiconductors. • Legal texts have been adapted to the new company name where appropriate. • Increased V_{LCD}, V_{DD1}, V_{DD2}, V_{DD3} max values in Table 15 • Increased V_{DD2}, V_{DD3} max values in Table 16 			
PCF8531 v.7	20131212	Product data sheet	-	PCF8531 v.6
PCF8531 v.6	20110516	Product data sheet	-	PCF8531 v.5
PCF8531 v.5	20100810	Product data sheet	-	PCF8531_4
PCF8531_4	20080613	Product data sheet	-	PCF8531_3
PCF8531_3	20000211	Product data sheet	-	PCF8531_2
PCF8531_2	19990810	Product data sheet	-	PCF8531_SDS_1
PCF8531_SDS_1	19990322	Product data sheet	-	-

24. Legal information

24.1 Data sheet status

Document status ^{[1][2]}	Product status ^[3]	Definition
Objective [short] data sheet	Development	This document contains data from the objective specification for product development.
Preliminary [short] data sheet	Qualification	This document contains data from the preliminary specification.
Product [short] data sheet	Production	This document contains the product specification.

[1] Please consult the most recently issued document before initiating or completing a design.

[2] The term 'short data sheet' is explained in section "Definitions".

[3] The product status of device(s) described in this document may have changed since this document was published and may differ in case of multiple devices. The latest product status information is available on the Internet at URL <http://www.nxp.com>.

24.2 Definitions

Draft — The document is a draft version only. The content is still under internal review and subject to formal approval, which may result in modifications or additions. NXP Semiconductors does not give any representations or warranties as to the accuracy or completeness of information included herein and shall have no liability for the consequences of use of such information.

Short data sheet — A short data sheet is an extract from a full data sheet with the same product type number(s) and title. A short data sheet is intended for quick reference only and should not be relied upon to contain detailed and full information. For detailed and full information see the relevant full data sheet, which is available on request via the local NXP Semiconductors sales office. In case of any inconsistency or conflict with the short data sheet, the full data sheet shall prevail.

Product specification — The information and data provided in a Product data sheet shall define the specification of the product as agreed between NXP Semiconductors and its customer, unless NXP Semiconductors and customer have explicitly agreed otherwise in writing. In no event however, shall an agreement be valid in which the NXP Semiconductors product is deemed to offer functions and qualities beyond those described in the Product data sheet.

24.3 Disclaimers

Limited warranty and liability — Information in this document is believed to be accurate and reliable. However, NXP Semiconductors does not give any representations or warranties, expressed or implied, as to the accuracy or completeness of such information and shall have no liability for the consequences of use of such information. NXP Semiconductors takes no responsibility for the content in this document if provided by an information source outside of NXP Semiconductors.

In no event shall NXP Semiconductors be liable for any indirect, incidental, punitive, special or consequential damages (including - without limitation - lost profits, lost savings, business interruption, costs related to the removal or replacement of any products or rework charges) whether or not such damages are based on tort (including negligence), warranty, breach of contract or any other legal theory.

Notwithstanding any damages that customer might incur for any reason whatsoever, NXP Semiconductors' aggregate and cumulative liability towards customer for the products described herein shall be limited in accordance with the *Terms and conditions of commercial sale* of NXP Semiconductors.

Right to make changes — NXP Semiconductors reserves the right to make changes to information published in this document, including without limitation specifications and product descriptions, at any time and without notice. This document supersedes and replaces all information supplied prior to the publication hereof.

Suitability for use — NXP Semiconductors products are not designed, authorized or warranted to be suitable for use in life support, life-critical or safety-critical systems or equipment, nor in applications where failure or malfunction of an NXP Semiconductors product can reasonably be expected to result in personal injury, death or severe property or environmental damage. NXP Semiconductors and its suppliers accept no liability for inclusion and/or use of NXP Semiconductors products in such equipment or applications and therefore such inclusion and/or use is at the customer's own risk.

Applications — Applications that are described herein for any of these products are for illustrative purposes only. NXP Semiconductors makes no representation or warranty that such applications will be suitable for the specified use without further testing or modification.

Customers are responsible for the design and operation of their applications and products using NXP Semiconductors products, and NXP Semiconductors accepts no liability for any assistance with applications or customer product design. It is customer's sole responsibility to determine whether the NXP Semiconductors product is suitable and fit for the customer's applications and products planned, as well as for the planned application and use of customer's third party customer(s). Customers should provide appropriate design and operating safeguards to minimize the risks associated with their applications and products.

NXP Semiconductors does not accept any liability related to any default, damage, costs or problem which is based on any weakness or default in the customer's applications or products, or the application or use by customer's third party customer(s). Customer is responsible for doing all necessary testing for the customer's applications and products using NXP Semiconductors products in order to avoid a default of the applications and the products or of the application or use by customer's third party customer(s). NXP does not accept any liability in this respect.

Limiting values — Stress above one or more limiting values (as defined in the Absolute Maximum Ratings System of IEC 60134) will cause permanent damage to the device. Limiting values are stress ratings only and (proper) operation of the device at these or any other conditions above those given in the Recommended operating conditions section (if present) or the Characteristics sections of this document is not warranted. Constant or repeated exposure to limiting values will permanently and irreversibly affect the quality and reliability of the device.

Terms and conditions of commercial sale — NXP Semiconductors products are sold subject to the general terms and conditions of commercial sale, as published at <http://www.nxp.com/profile/terms>, unless otherwise agreed in a valid written individual agreement. In case an individual agreement is concluded only the terms and conditions of the respective agreement shall apply. NXP Semiconductors hereby expressly objects to applying the customer's general terms and conditions with regard to the purchase of NXP Semiconductors products by customer.

No offer to sell or license — Nothing in this document may be interpreted or construed as an offer to sell products that is open for acceptance or the grant, conveyance or implication of any license under any copyrights, patents or other industrial or intellectual property rights.

Export control — This document as well as the item(s) described herein may be subject to export control regulations. Export might require a prior authorization from competent authorities.

Non-automotive qualified products — Unless this data sheet expressly states that this specific NXP Semiconductors product is automotive qualified, the product is not suitable for automotive use. It is neither qualified nor tested in accordance with automotive testing or application requirements. NXP Semiconductors accepts no liability for inclusion and/or use of non-automotive qualified products in automotive equipment or applications.

In the event that customer uses the product for design-in and use in automotive applications to automotive specifications and standards, customer (a) shall use the product without NXP Semiconductors' warranty of the product for such automotive applications, use and specifications, and (b) whenever customer uses the product for automotive applications beyond NXP Semiconductors' specifications such use shall be solely at customer's own risk, and (c) customer fully indemnifies NXP Semiconductors for any liability, damages or failed product claims resulting from customer design and use of the product for automotive applications beyond NXP Semiconductors' standard warranty and NXP Semiconductors' product specifications.

Translations — A non-English (translated) version of a document is for reference only. The English version shall prevail in case of any discrepancy between the translated and English versions.

Bare die — All die are tested on compliance with their related technical specifications as stated in this data sheet up to the point of wafer sawing and are handled in accordance with the NXP Semiconductors storage and transportation conditions. If there are data sheet limits not guaranteed, these will be separately indicated in the data sheet. There are no post-packing tests performed on individual die or wafers.

NXP Semiconductors has no control of third party procedures in the sawing, handling, packing or assembly of the die. Accordingly, NXP Semiconductors assumes no liability for device functionality or performance of the die or systems after third party sawing, handling, packing or assembly of the die. It is the responsibility of the customer to test and qualify their application in which the die is used.

All die sales are conditioned upon and subject to the customer entering into a written die sale agreement with NXP Semiconductors through its legal department.

24.4 Trademarks

Notice: All referenced brands, product names, service names and trademarks are the property of their respective owners.

I²C-bus — logo is a trademark of NXP Semiconductors N.V.

25. Contact information

For more information, please visit: <http://www.nxp.com>

For sales office addresses, please send an email to: salesaddresses@nxp.com

26. Tables

Table 1.	Ordering information	2
Table 2.	Ordering options	2
Table 3.	Pad allocation table	5
Table 4.	Alignment markers for PCF8531	5
Table 5.	Bonding pad dimensions	6
Table 6.	Bonding pad description	6
Table 7.	Y address	21
Table 8.	Multiplex rates	21
Table 9.	Programming the required bias system	22
Table 10.	Intermediate LCD bias voltages	23
Table 11.	Parameter values for the HV generator programming	24
Table 12.	Instruction set	25
Table 13.	Explanation for symbols in Table 12	26
Table 14.	Description of bits H, D and E, TC and S	26
Table 15.	Limiting values [1]	34
Table 16.	Static characteristics	35
Table 17.	Dynamic characteristics	36
Table 18.	Programming example for PCF8531	43
Table 19.	Tray dimensions (see Figure 34)	46
Table 20.	Selection of LCD graphic drivers	48
Table 21.	Abbreviations	49
Table 22.	Revision history	51

27. Figures

Fig 1.	Block diagram of PCF8531	3
Fig 2.	Bonding pad location for PCF8531	4
Fig 3.	Alignment markers	5
Fig 4.	Chip dimensions	6
Fig 5.	Typical LCD driver waveforms	16
Fig 6.	LCD waveforms, icon mode, multiplex rate 1:2	17
Fig 7.	DDRAM to display data mapping	18
Fig 8.	RAM format and addressing	19
Fig 9.	Sequence of writing data bytes into RAM with vertical addressing ($V = 1$)	19
Fig 10.	Sequence of writing data bytes into RAM with horizontal addressing ($V = 0$)	19
Fig 11.	Voltage divider chain	22
Fig 12.	V_{LCD} programming of PCF8531	24
Fig 13.	V_{LCD} as a function of liquid crystal temperature	25
Fig 14.	Bit transfer	28
Fig 15.	Definition of START and STOP conditions	28
Fig 16.	System configuration	29
Fig 17.	Acknowledge on the I ² C-bus	30
Fig 18.	Slave address and control byte	31
Fig 19.	Master transmits to slave receiver; write mode	31
Fig 20.	Device protection diagrams	32
Fig 21.	Reset timing	37
Fig 22.	I ² C-bus timing	37
Fig 23.	Supply current as a function of supply voltage 2 and supply voltage 3	38
Fig 24.	Supply current as a function of LCD supply voltage; different multiplication factors	38
Fig 25.	LCD supply voltage as a function of temperature	38
Fig 26.	Supply current as a function of LCD supply voltage	38
Fig 27.	Supply current as a function of frequency	39
Fig 28.	Supply current as a function of LCD supply voltage	39
Fig 29.	Typical system configuration	40
Fig 30.	Recommended V_{DD} connections for internal V_{LCD} generation	40
Fig 31.	Recommended V_{LCD} connections for internal V_{LCD} generation	41
Fig 32.	Recommended V_{DD} connections for external V_{LCD} generation	41
Fig 33.	Chip-on-glass application	42
Fig 34.	Tray details	46
Fig 35.	Tray alignment	47

28. Contents

1	General description	1	10.1.3	System configuration	28
2	Features and benefits	1	10.1.4	Acknowledge	29
3	Applications	2	10.2	I ² C-bus protocol	30
4	Ordering information	2	10.3	Command decoder	31
4.1	Ordering options	2	11	Internal circuitry	32
5	Block diagram	3	12	Safety notes	33
6	Pinning information	4	13	Limiting values	34
6.1	Pinning	4	14	Static characteristics	35
6.2	Pin description	6	15	Dynamic characteristics	36
7	Functional description	14	16	Application information	40
7.1	Oscillator	14	16.1	Typical system configuration	40
7.2	Power-On Reset (POR)	14	16.2	Power supply connections for internal V _{LCD} generation	40
7.3	I ² C-bus controller	14	16.3	Power supply connections for external V _{LCD} generation	41
7.4	Input filters	14	16.4	Information about V _{LCD} connections	41
7.5	Display data RAM	14	16.5	Chip-on-glass application	42
7.6	Timing generator	14	16.6	Programming example	43
7.7	Address counter	14	17	Package outline	46
7.8	Display address counter	14	18	Handling information	46
7.9	Command decoder	14	19	Packing information	46
7.10	Bias voltage generator	15	20	Appendix	48
7.11	V _{LCD} generator	15	20.1	LCD graphic driver selection	48
7.12	Reset	15	21	Abbreviations	49
7.13	Power-down	15	22	References	50
7.14	Column driver outputs	15	23	Revision history	51
7.15	Row driver outputs	15	24	Legal information	52
8	LCD waveforms and DDRAM to data mapping	16	24.1	Data sheet status	52
8.1	Addressing	18	24.2	Definitions	52
9	Instructions	20	24.3	Disclaimers	52
9.1	Reset	20	24.4	Trademarks	53
9.2	Function set	21	25	Contact information	53
9.2.1	PD	21	26	Tables	54
9.2.2	V	21	27	Figures	55
9.3	Set Y address	21	28	Contents	56
9.4	Set X address	21			
9.5	Set multiplex rate	21			
9.6	Display control (D, E, and IM)	21			
9.7	Set bias system	22			
9.8	LCD bias voltage	23			
9.9	Set V _{LCD} value	23			
9.10	Voltage multiplier control S[1:0]	24			
9.11	Temperature compensation	24			
10	I²C-bus interface	28			
10.1	Characteristics of the I ² C-bus	28			
10.1.1	Bit transfer	28			
10.1.2	START and STOP conditions	28			

Please be aware that important notices concerning this document and the product(s) described herein, have been included in section 'Legal information'.

© NXP Semiconductors N.V. 2014.

All rights reserved.

For more information, please visit: <http://www.nxp.com>

For sales office addresses, please send an email to: salesaddresses@nxp.com

Date of release: 12 September 2014

Document identifier: PCF8531