



# *Data Sheet*

***NT39207***

**480/320 Outputs TFT LCD Gate Driver**

***Version 0.11***

***Preliminary***

---

1	REVISION HISTORY .....	3
2	FEATURES .....	4
3	GENERAL DESCRIPTION .....	4
4	PIN ASSIGNMENT .....	5
5	BLOCK DIAGRAM .....	6
6	PIN AND PAD DESCRIPTIONS .....	7
7	FUNCTIONAL DESCRIPTION .....	10
8	ABSOLUTE MAXIMUM RATINGS .....	12
9	DC ELECTRICAL CHARACTERISTICS .....	12
10	AC ELECTRICAL CHARACTERISTICS .....	13
11	TIMING WAVEFORMS .....	14
12	CHIP OUTLINE DIMENSIONS .....	19
13	BONDING DIAGRAM .....	20

NOVATEK CONFIDENTIAL  
NO DISCLOSURE

**Revision History**

<b>NT39207 Specification Revision History</b>		
<b>Version</b>	<b>Content</b>	<b>Data</b>
0.0	Original	2005/6/20
0.1	Add power on/off sequence (page 10,11)	2005/6/23
0.2	Modify identification of chip size (page 20)	2005/7/13
0.3	Modify VEE waveform of power sequence (page 10,11) 1*OE to 3*OE (page 7,8) Add pads for MODE,XON & dimension modified (page 20)	2005/8/30
0.4	Modify dummy pins' location & pad size (page 20)	2005/10/18
0.5	Modify Bonding Diagram (page 21)	2005/10/19
0.6	Correct pass line table (page 9) and remove label PWCL (page 14)	2005/12/20
0.7	Add waveforms under IC work with 3-OE. (page 19)	2005/12/23
0.8	Modify alignment mark. (page 20)	2006/01/16
0.9	Modify pass line table (page 9)	2006/04/03
0.10	Modify the definition of "MODE" (page 8)	2006/04/07
0.11	Modify the description of power on/off sequence (page 10)	2007/01/18

**Features**

- Gate driver for TFT LCD panel
- 480/320 channel outputs+2pins (Fixed to VEE)
- Bi-directional shift selectable function
- Driving voltage: VEE + 40V
- Double gate scan
- 2.7 ~ 3.6V logical interface
- Cascade function for dot-expansion
- CMOS silicon gate (P-type)
- COG solution

**General Description**

NT39207 is a dedicated gate driver IC for TFT LCD Panel. After a start pulse is triggered, output pins will output high-driving voltage pulses sequentially for the gate signals of the LCD Panel. This chip also provides shift up/down selection and cascade functions for dot expansion. The special pin location is designed for COG manufacture.

NOVATEK CONFIDENTIAL  
NO DISCLOSURE

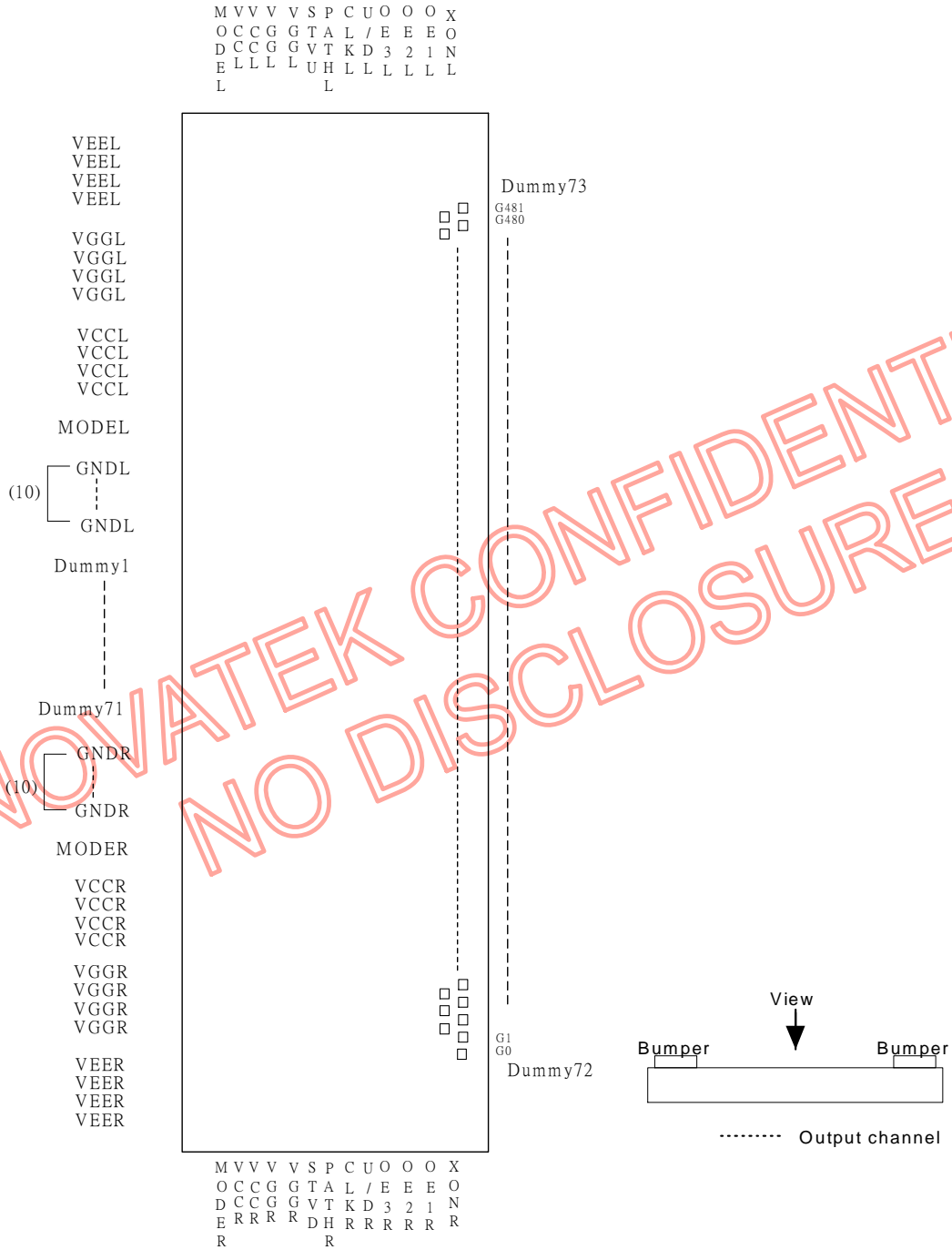
**Pin Assignment**

NOVATEK CONFIDENTIAL  
NO DISCLOSURE

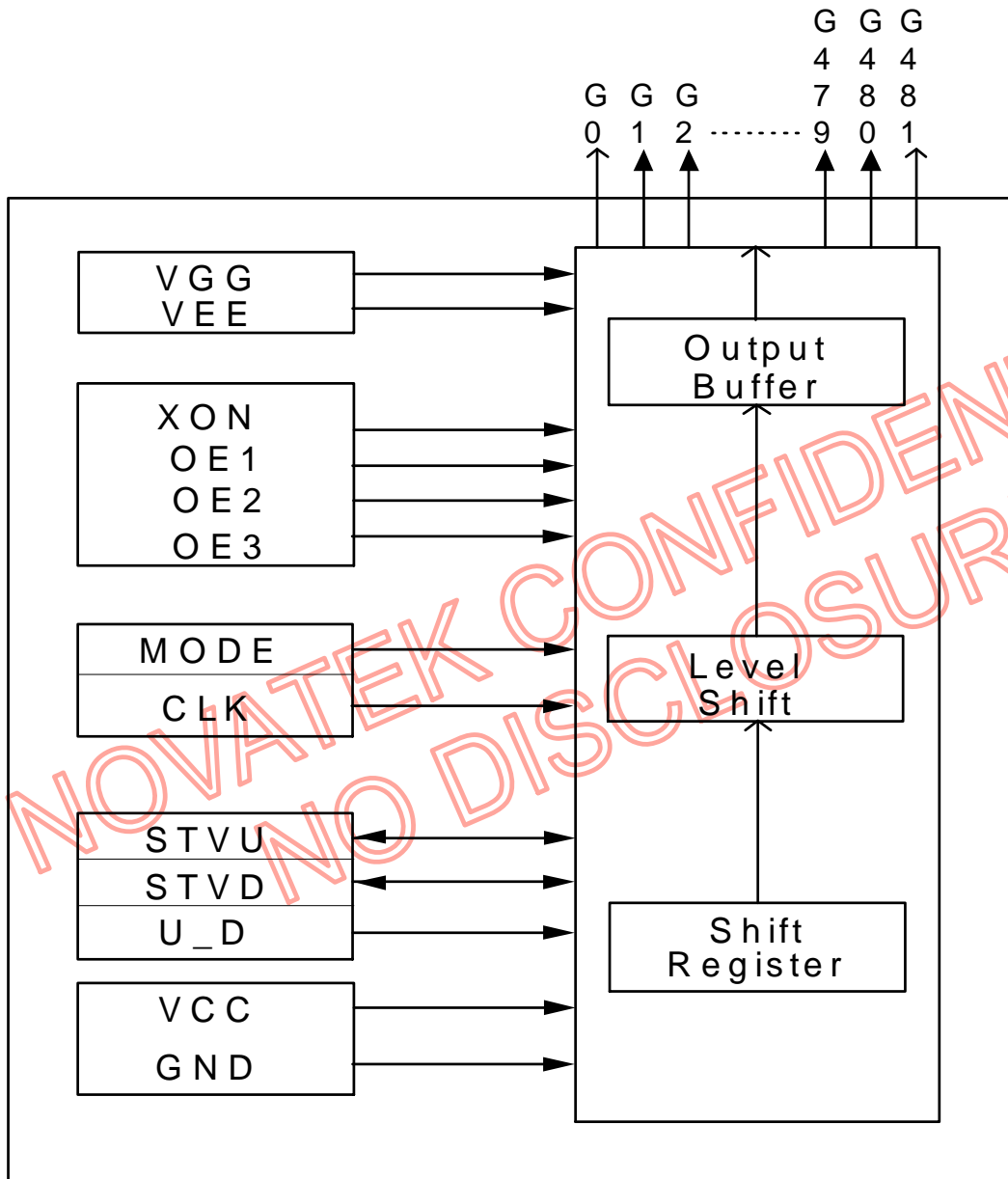
**Block Diagram**

**Pin Descriptions**

Designation	I/O	Descriptions
XONR, XONL	I	Active Low, When XON goes low, all outputs are fixed to VGG. And there is a 200k ohm pull-up resistor with this pin. Xon signal has priority over OE.
OE1R, OE1L	I	Output enabled; these pads are shorted internally; active high. When this pin is applied to "1", the (3n+1) <sup>th</sup> channel output, n=0, 1, 2, ...159, are disabled (=VEE). This condition will not affect the operation of the internal registers. OE1 control is independent with the CLK. If only use one OE, these OE pins (OE1~3) have to be shorted together.
OE2R, OE2L	I	Output enabled; these pads are shorted internally; active high. When this pin is applied to "1", the (3n+2) <sup>th</sup> channel output, n=0, 1, 2, ...159, are disabled (=VEE). This condition will not affect the operation of the internal registers. OE2 control is independent with the CLK. If only use one OE, these OE pins (OE1~3) have to be shorted together.
OE3R, OE3L	I	Output enabled; these pads are shorted internally; active high. When this pin is applied to "1", the (3n+3) <sup>th</sup> channel output, n=0, 1, 2, ...159, are disabled (=VEE). This condition will not affect the operation of the internal registers. OE2 control is independent with the CLK. If only use one OE, these OE pins (OE1~3) have to be shorted together.
U_DR, U_DL	I	Shift up or down control. U_D = "H", up shift: STVD (Input) → G1 ~ G480 → STVU (Output) U_D = "L", down shift: STVU (Input) → G480 ~ G1 → STVD (Output)
CLKR, CLKL	I	Shift clock. Clock signal for internal shift register.
PATHR PATHL	-	Linked together internal.
STVD	I/O	It is an input pin to receive a start pulse when U_D = "1" or an output pin to shift a start pulse to the next stage when U_D = "0". The function is the same as STVU but logical inversion. Please refer to the descriptions of "STVU" and "U_D".
STVU	I/O	It is an input pin when U_D = "0". A "high" pulse is latched at the rising edge of the shift clock, CLK. After a start pulse, a serial pulses are shifted from G480 to G1, and STVD for the next stage.  It is an output pin when U_D = "1". A start pulse is shifted for the next stage at the falling edge of the 480th clock of the shift clock.

MODER MODEL	I	Selecting the output mode: 480/320 channels, Normally <b>pull– low</b> . MODE="L": 320 channels (G161~G320 are disabled and fixed to VEE). <b>Default setting is MODE="L"</b> . MODE="H": 480 channels.																																																																																																				
		<table border="1"> <thead> <tr> <th>Output Channel</th> <th>320CH (MODE="L")</th> <th>480CH (MODE="H")</th> <th>320CH OE Control</th> <th>480CH OE Control</th> </tr> </thead> <tbody> <tr><td>G1</td><td>1<sup>st</sup></td><td>1<sup>st</sup></td><td>OE1</td><td>OE1</td></tr> <tr><td>G2</td><td>2<sup>nd</sup></td><td>2<sup>nd</sup></td><td>OE2</td><td>OE2</td></tr> <tr><td>G3</td><td>3<sup>rd</sup></td><td>3<sup>rd</sup></td><td>OE3</td><td>OE3</td></tr> <tr><td>:</td><td>:</td><td>:</td><td>:</td><td>:</td></tr> <tr><td>G159</td><td>159<sup>th</sup></td><td>159<sup>th</sup></td><td>OE3</td><td>OE3</td></tr> <tr><td>G160</td><td>160<sup>th</sup></td><td>160<sup>th</sup></td><td>OE1</td><td>OE1</td></tr> <tr><td>G161</td><td>Fix to VEE</td><td>161<sup>th</sup></td><td>-</td><td>OE2</td></tr> <tr><td>G162</td><td>Fix to VEE</td><td>162<sup>th</sup></td><td>-</td><td>OE3</td></tr> <tr><td>G163</td><td>Fix to VEE</td><td>163<sup>th</sup></td><td>-</td><td>OE1</td></tr> <tr><td>:</td><td>:</td><td>:</td><td>:</td><td>:</td></tr> <tr><td>G318</td><td>Fix to VEE</td><td>318<sup>th</sup></td><td>-</td><td>OE3</td></tr> <tr><td>G319</td><td>Fix to VEE</td><td>319<sup>th</sup></td><td>-</td><td>OE1</td></tr> <tr><td>G320</td><td>Fix to VEE</td><td>320<sup>th</sup></td><td>-</td><td>OE2</td></tr> <tr><td>G321</td><td>161<sup>th</sup></td><td>321<sup>th</sup></td><td>OE2</td><td>OE3</td></tr> <tr><td>G322</td><td>162<sup>th</sup></td><td>322<sup>th</sup></td><td>OE3</td><td>OE1</td></tr> <tr><td>:</td><td>:</td><td>:</td><td>:</td><td>:</td></tr> <tr><td>G478</td><td>318<sup>th</sup></td><td>478<sup>th</sup></td><td>OE3</td><td>OE1</td></tr> <tr><td>G479</td><td>319<sup>th</sup></td><td>479<sup>th</sup></td><td>OE1</td><td>OE2</td></tr> <tr><td>G480</td><td>320<sup>th</sup></td><td>480<sup>th</sup></td><td>OE2</td><td>OE3</td></tr> </tbody> </table>	Output Channel	320CH (MODE="L")	480CH (MODE="H")	320CH OE Control	480CH OE Control	G1	1 <sup>st</sup>	1 <sup>st</sup>	OE1	OE1	G2	2 <sup>nd</sup>	2 <sup>nd</sup>	OE2	OE2	G3	3 <sup>rd</sup>	3 <sup>rd</sup>	OE3	OE3	:	:	:	:	:	G159	159 <sup>th</sup>	159 <sup>th</sup>	OE3	OE3	G160	160 <sup>th</sup>	160 <sup>th</sup>	OE1	OE1	G161	Fix to VEE	161 <sup>th</sup>	-	OE2	G162	Fix to VEE	162 <sup>th</sup>	-	OE3	G163	Fix to VEE	163 <sup>th</sup>	-	OE1	:	:	:	:	:	G318	Fix to VEE	318 <sup>th</sup>	-	OE3	G319	Fix to VEE	319 <sup>th</sup>	-	OE1	G320	Fix to VEE	320 <sup>th</sup>	-	OE2	G321	161 <sup>th</sup>	321 <sup>th</sup>	OE2	OE3	G322	162 <sup>th</sup>	322 <sup>th</sup>	OE3	OE1	:	:	:	:	:	G478	318 <sup>th</sup>	478 <sup>th</sup>	OE3	OE1	G479	319 <sup>th</sup>	479 <sup>th</sup>	OE1	OE2	G480	320 <sup>th</sup>	480 <sup>th</sup>	OE2	OE3
		Output Channel	320CH (MODE="L")	480CH (MODE="H")	320CH OE Control	480CH OE Control																																																																																																
		G1	1 <sup>st</sup>	1 <sup>st</sup>	OE1	OE1																																																																																																
		G2	2 <sup>nd</sup>	2 <sup>nd</sup>	OE2	OE2																																																																																																
		G3	3 <sup>rd</sup>	3 <sup>rd</sup>	OE3	OE3																																																																																																
		:	:	:	:	:																																																																																																
		G159	159 <sup>th</sup>	159 <sup>th</sup>	OE3	OE3																																																																																																
		G160	160 <sup>th</sup>	160 <sup>th</sup>	OE1	OE1																																																																																																
		G161	Fix to VEE	161 <sup>th</sup>	-	OE2																																																																																																
		G162	Fix to VEE	162 <sup>th</sup>	-	OE3																																																																																																
		G163	Fix to VEE	163 <sup>th</sup>	-	OE1																																																																																																
		:	:	:	:	:																																																																																																
		G318	Fix to VEE	318 <sup>th</sup>	-	OE3																																																																																																
		G319	Fix to VEE	319 <sup>th</sup>	-	OE1																																																																																																
		G320	Fix to VEE	320 <sup>th</sup>	-	OE2																																																																																																
		G321	161 <sup>th</sup>	321 <sup>th</sup>	OE2	OE3																																																																																																
		G322	162 <sup>th</sup>	322 <sup>th</sup>	OE3	OE1																																																																																																
		:	:	:	:	:																																																																																																
		G478	318 <sup>th</sup>	478 <sup>th</sup>	OE3	OE1																																																																																																
G479	319 <sup>th</sup>	479 <sup>th</sup>	OE1	OE2																																																																																																		
G480	320 <sup>th</sup>	480 <sup>th</sup>	OE2	OE3																																																																																																		
VGGR, VGGL	PI	Positive power supply for G1 ~ G480 outputs																																																																																																				
VEER, VEEL	PI	Negative power supply for G0 ~ G481 outputs																																																																																																				
VCCR, VCCL	PI	Power supply for digital circuit.																																																																																																				
GNDR, GNDL	PI	Ground pin																																																																																																				
G1 ~ G480	O	For driving LCD's gate signals, the output amplitude of these pins is VGG - VEE. Output timing of these signals is synchronous with the rising edge of shift clock.																																																																																																				
G0, G481	O	LCD panel auxiliary pins. Regardless of shift data, these pins output VEE level.																																																																																																				

- I : Input, O : Output, P : Power, D : Dummy, S : Shorted line, M : Mark, PI : Power input, PO : Power output,  
 T : For testing, I/O : Input / Output. PS: Power Setting, C: Capacitor pin.  
 ■ U\_DL = U/DL , U\_DR = U/DR , U\_D=U/D



**Pass line pin name**

Pass Line No	Pad Name	
1	XONR	XONL
2	OE1R	OE1L
3	OE2R	OE2L
4	OE3R	OE3L
5	U_DR	U_DL
6	CLKR	CLKL
7	PATHR	PATHL
8	VGGR	VGGL
9	VCCR	VCCL
10	MODER	MODEL
11	VEER	VEEL

NOVATEK CONFIDENTIAL  
NO DISCLOSURE

## Functional Description

### 1. Power on/off sequence:

This IC is a high-voltage LCD driver, so it may be damaged by a large current flow if an incorrect power sequence is used. A recommended sequence is to connect the drive powers ,VEE & VGG , after the initialization of logic power, VCC.

For power-off sequence , either turning off logic system after shutting off the drive power or turning off all power simultaneously at the same time are suggested.

#### ■ Power on sequence

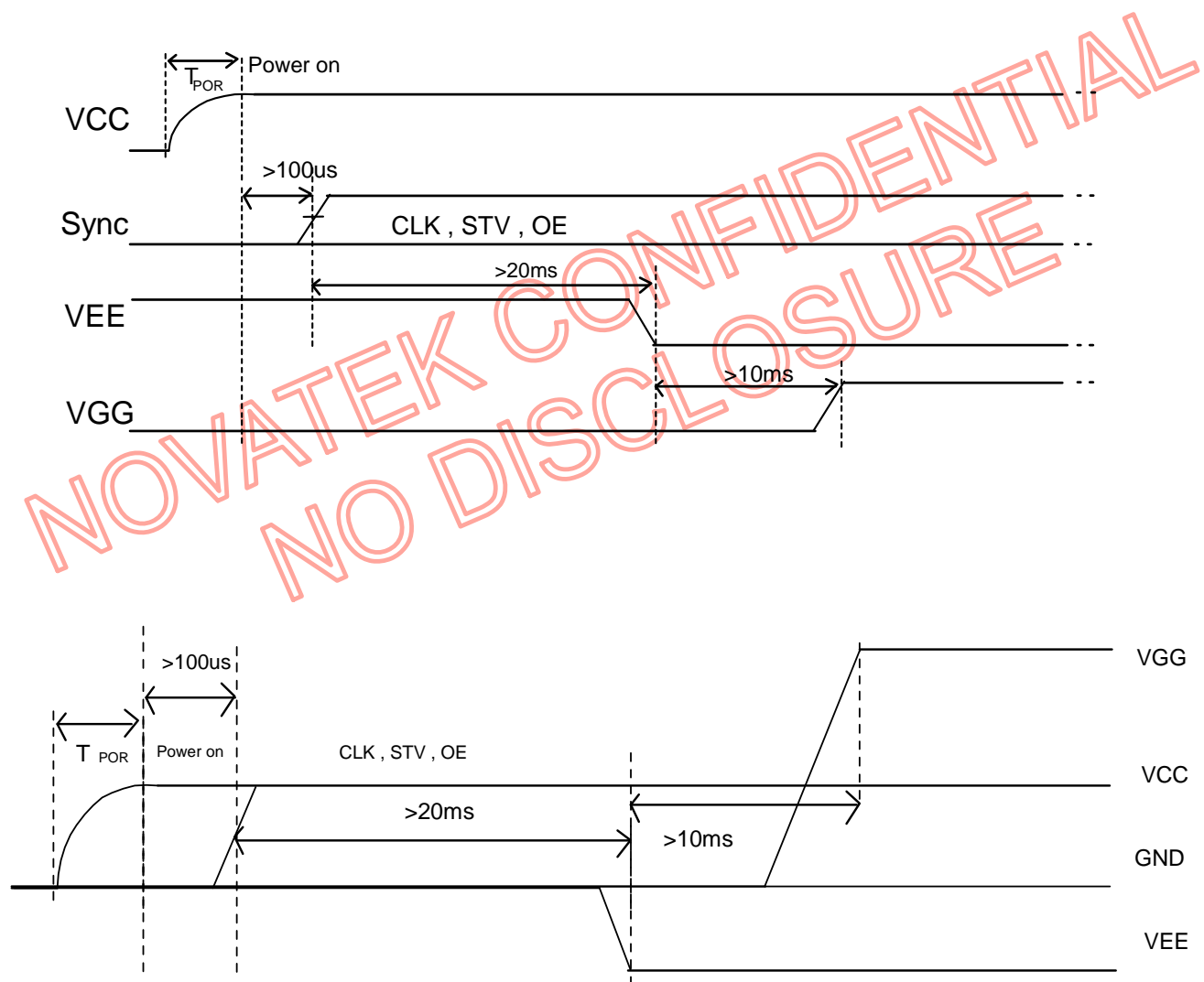

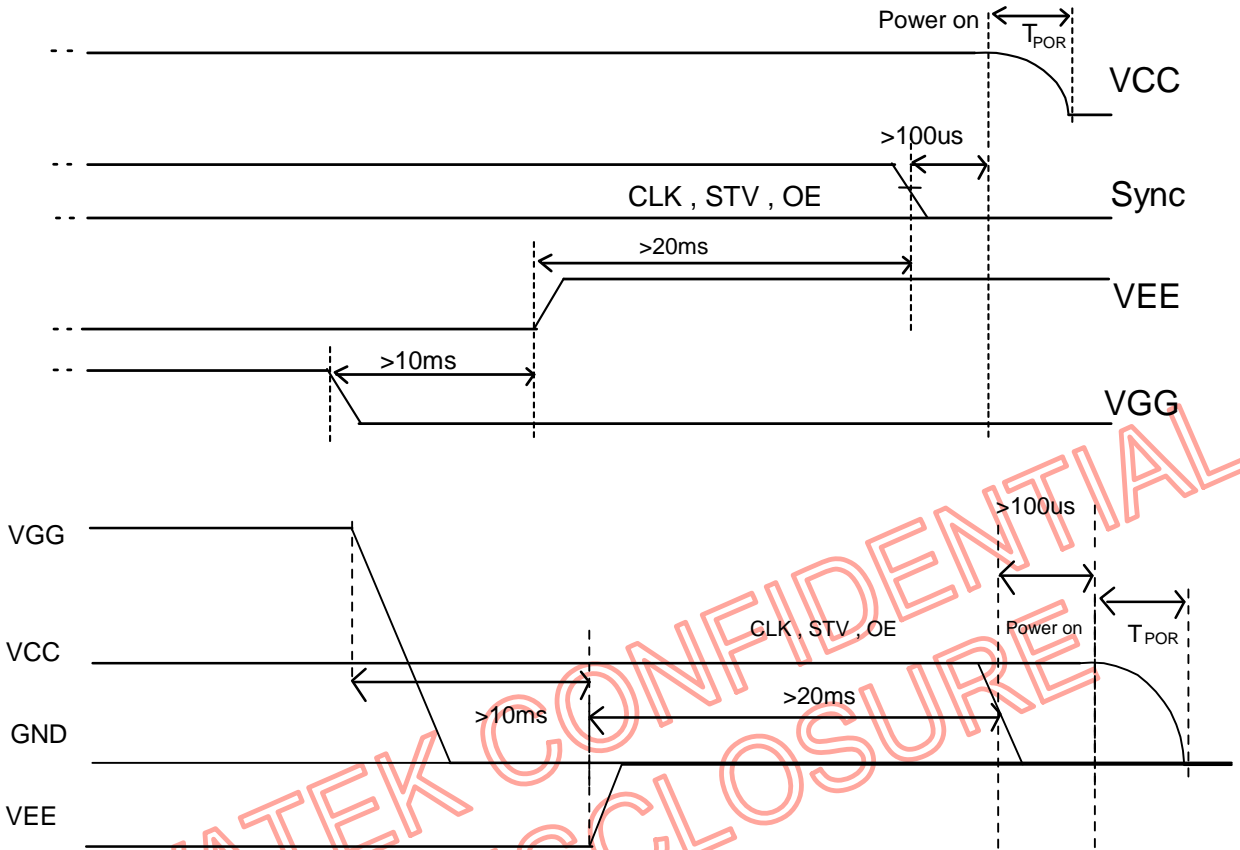
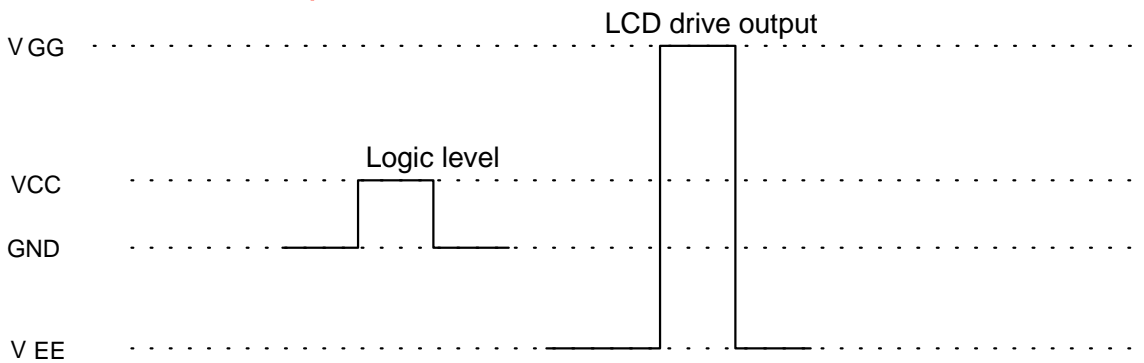
**■ Power off sequence**

**2. Power level:**

Note: For the input signals: CLK, XON, OE, U\_D, STVD & STVU, MODE, "High" level=VCC, "Low" level=GND

**Absolute Maximum Rating\***

Logic supply voltage, VCC	- 0.3V to +6V
Supply voltage, VGG	- 0.3V to +40V
Supply voltage, VEE	- 20V to +0.3V
Supply range, VGG-VEE	- 0.3V to +40V
Operating temperature	-30 °C to 85 °C
Storage temperature	-55 °C to 125 °C

**\*Comments**

Stresses above those listed under "Absolute Maximum Rating" may cause permanent damage to the device. These are stress ratings only. Functional operation of this device at these or any other conditions above those indicated in the operational sections of this specification is not implied and exposure to absolute maximum rating conditions for extended periods may affect device reliability.

**DC Electrical Characteristics**

Symbol	Parameters	Min.	Typ.	Max.	Unit	Conditions
VGG	VGG Voltage	7	-	VEE +40	V	
VEE	VEE Voltage	-20	-	-5	V	
Vxo	Voltage Range of VGG - VEE	12	-	40	V	VCC = 3.3V
VCC	VCC Supplied Voltage	2.7	3.3	3.6	V	
VIH	High Level Input Voltage	0.7 X VCC	-	VCC	V	VCC = 3.3V
VIL	Low Level Input Voltage	0	-	0.3 X VCC	V	VCC = 3.3V
IXOH	High Level Output Current	0.5	-	-	mA	Driving current, VO = VGG -0.5V
IXOL	Low Level Output Current	-0.5	-	-	mA	Sink current, VO = VEE + 0.5V
IPOH	High Level Output Current	200	-	-	uA	STVD/STVU, VO = VCC - 0.3V
IPOL	Low Level Output Current	-200	-	-	uA	STVD/STVU, VO = 0.3V
Rin	Pull-up Impedance	70K	200K	-	ohm	XON , MODER,MODEL
IIL	Input Leakage Current	-	-	± 1	uA	Except XON & MODER,MODEL
ICC	Operating Current Consumption	-	-	50	uA	VCC=3.3V, Fclk=20KHz, No load
IGG	Operating Current Consumption	-	-	100	uA	VGG=25V, Fclk=20KHz, No load
IEE	Operating Current Consumption	-	-	-100	uA	VEE=-15V, Fclk=20KHz, No load

**AC Characteristics (VGG=25V, VEE=-15V, VCC=3.3V, GND=0V, TA= 25°C)**

Symbol	Parameters	Min.	Typ.	Max.	Unit	Conditions
Tdt	STVD/STVU Delay Time	-	-	500	ns	CL = 20pF
Tdo	Driver Output Delay Time	-	-	900	ns	CL = 220pF
Tthl	Output Falling Time	-	400	800	ns	CL = 220pF, 90% to 10%
Tthh	Output Rise Time	-	500	1000	ns	CL = 220pF, 10% to 90%
Txon	XON to Driver Output Delay Time	-	-	10	us	CL = 220pF
Toe	OE to Driver Output Delay Time	-	-	900	ns	CL = 220pF
Fclk	Clock Frequency	-	-	200	KHz	In cascade connection
Trck	Clock Rise Time	-	-	100	ns	CL = 20pF
Tfck	Clock Falling Time	-	-	100	ns	CL = 20pF
PWCLK	Clock Pulse Width ( High period or Low period )	500	-	-	ns	
Tsu	STVD/STVU Set-up Time	200	-	-	ns	
Thd	STVD/STVU Hold Time	300	-	-	ns	
Twcl	Output Enabled pulse width	1	-	-	us	
T <sub>POR</sub>	Power-On Reset slew time	-	-	5	ms	From 0V to 90% VCC

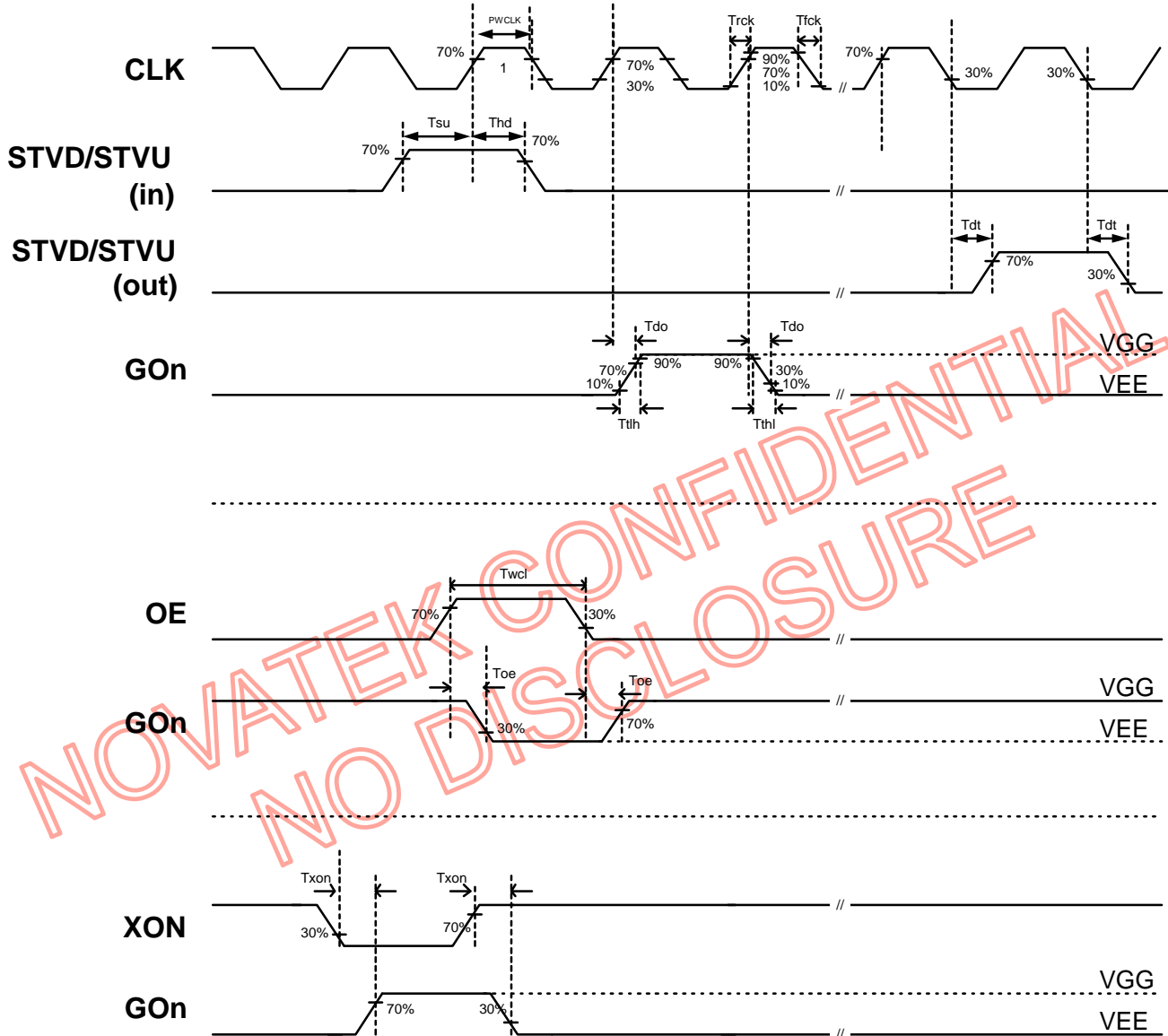
**Timing Waveforms**

**Operation(Single-pulse)**

1. U/D = "H"

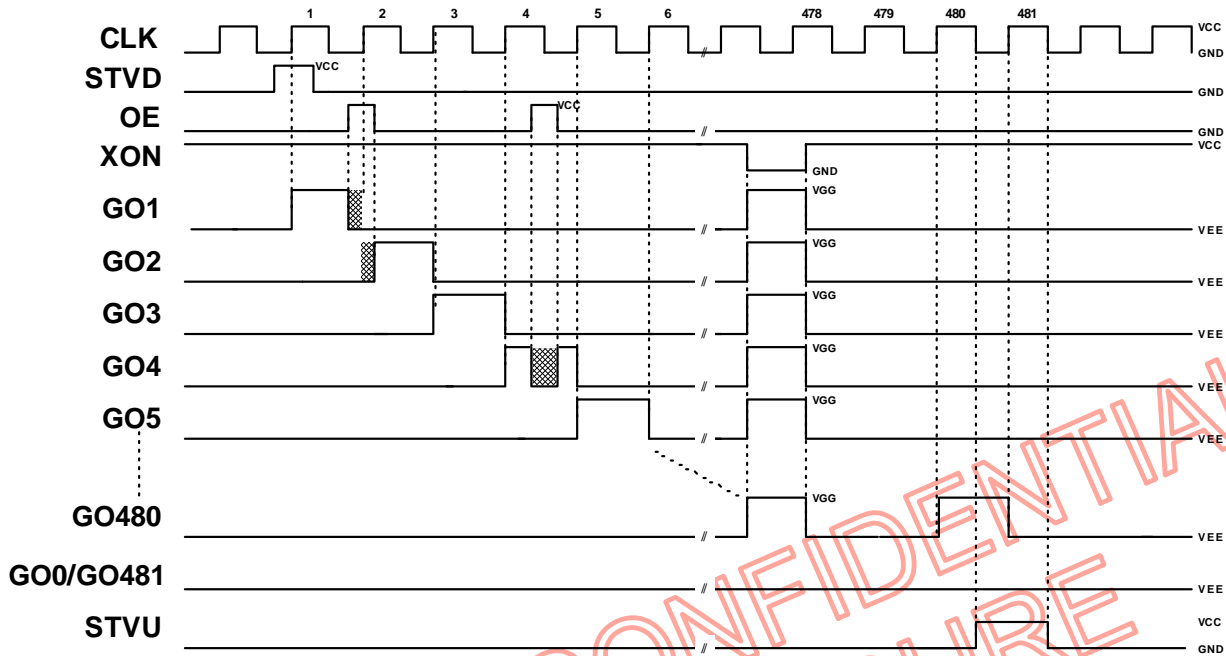

2. U/D = "L"

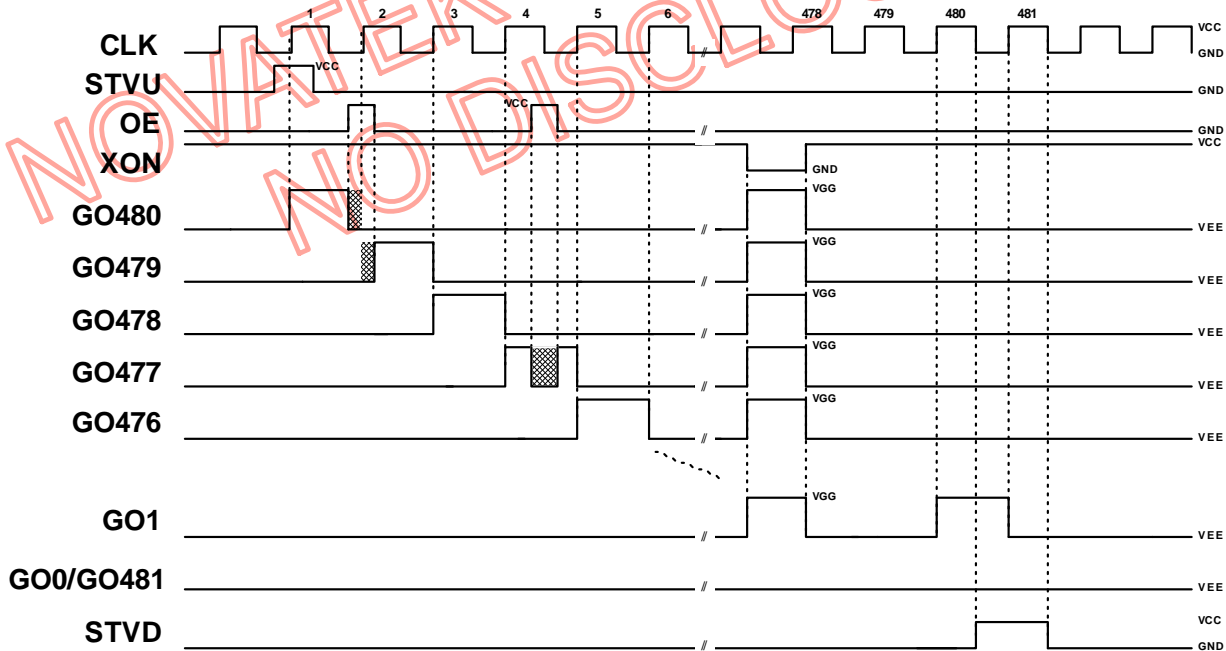

 Deleted from normal output by OE

**Operation(Double-pulse)**

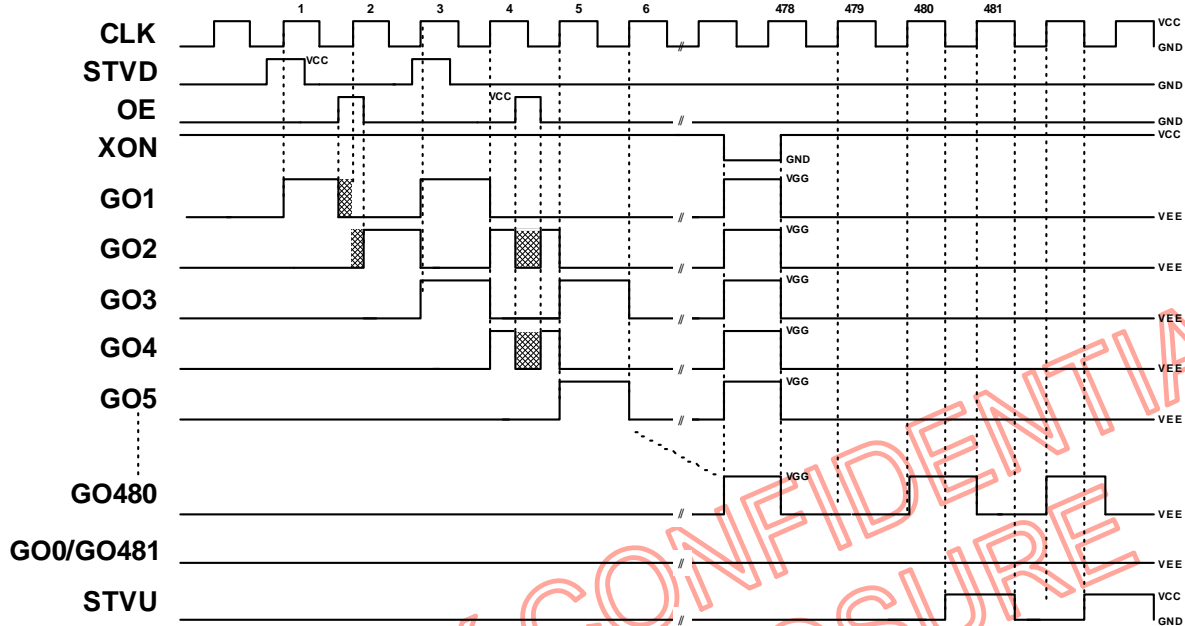
1. U/D = "H"

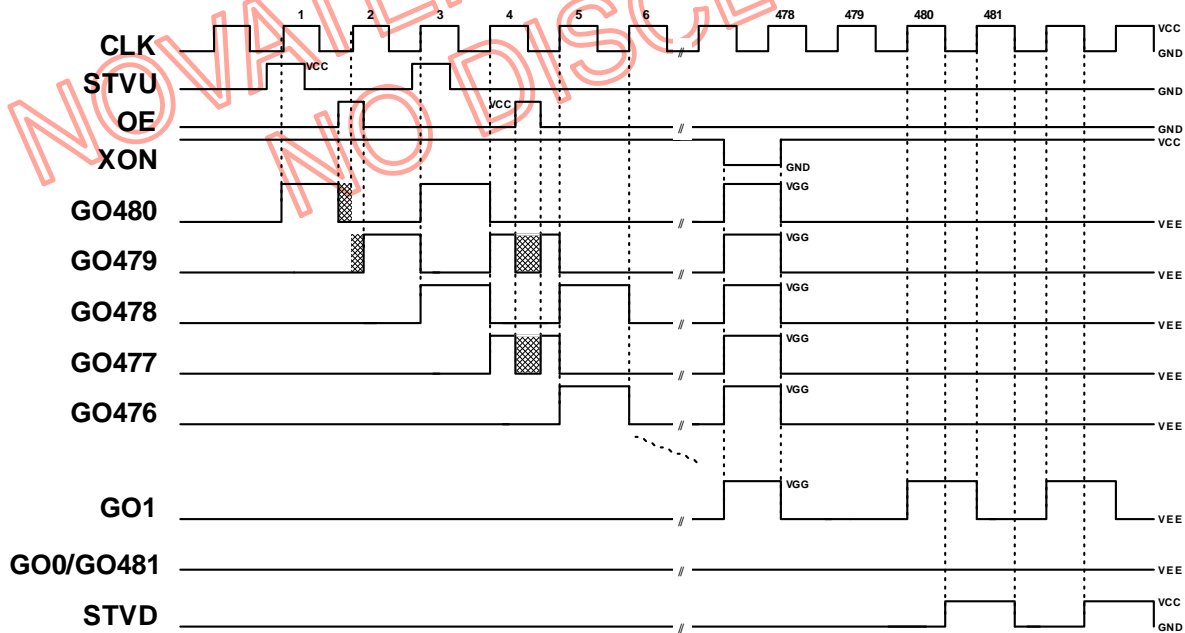

2. U/D = "L"



 : Deleted from normal output by OE

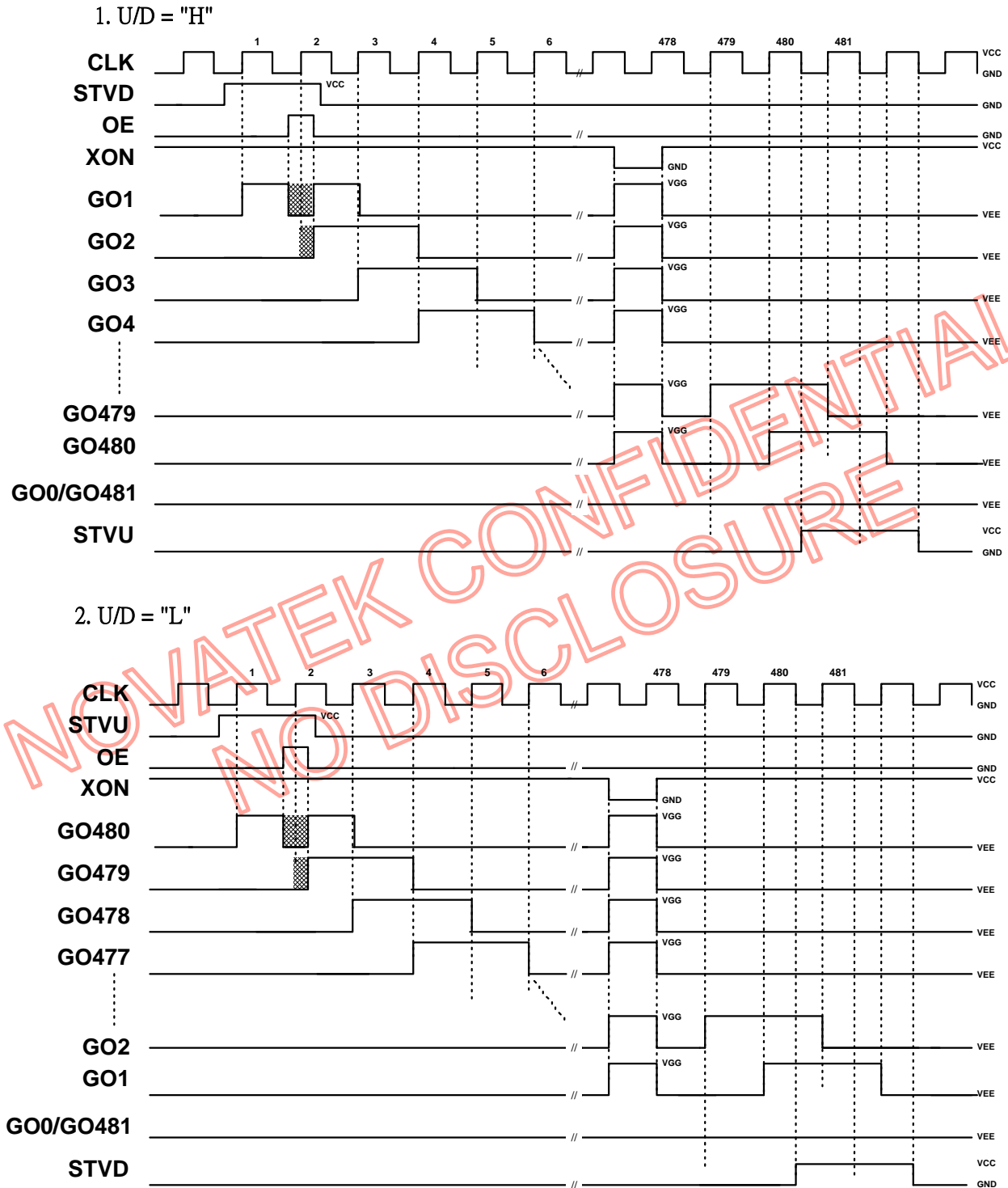

**Operation( long start pulse )(2CKV)**

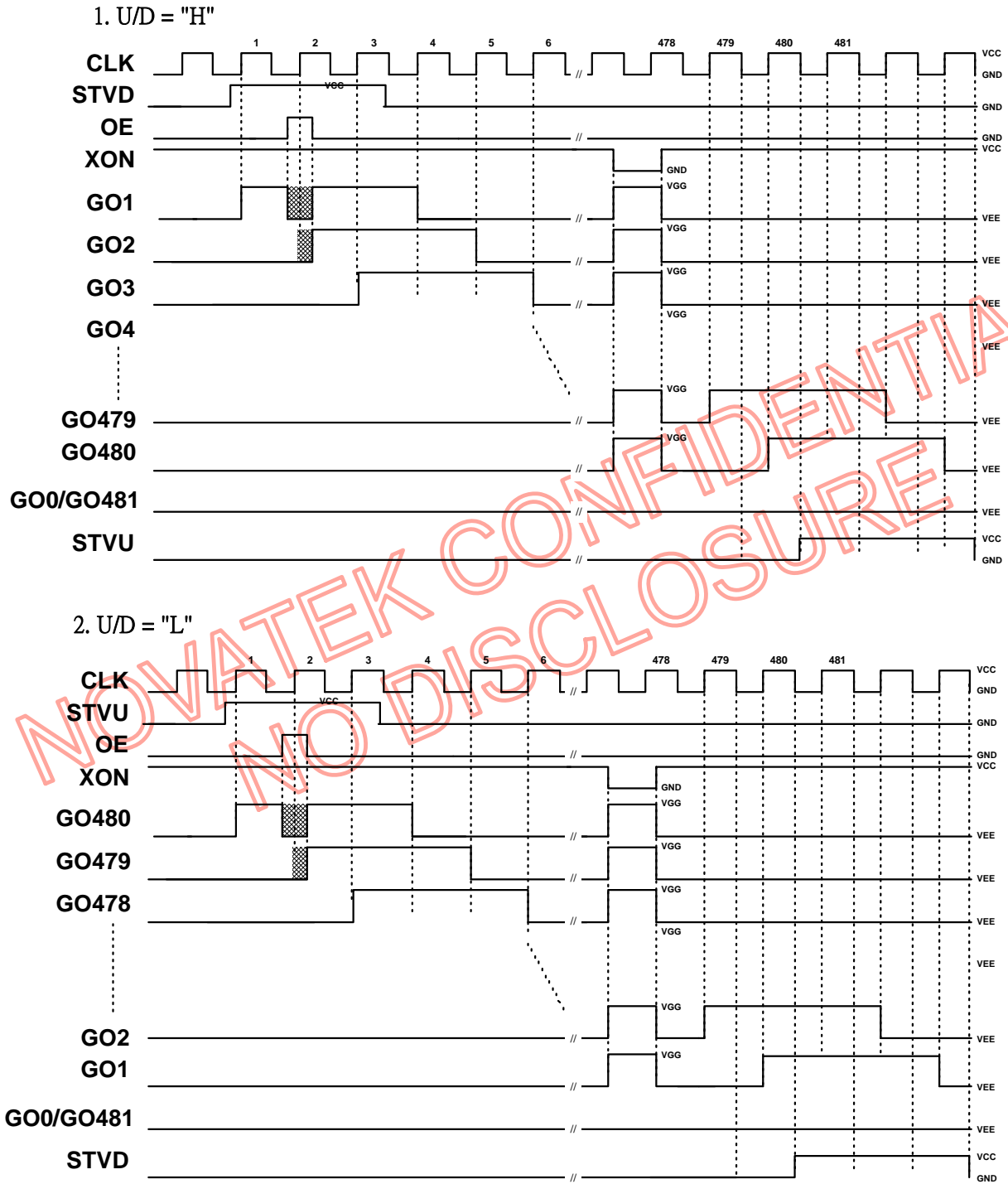
▨ : Deleted from normal output by OE

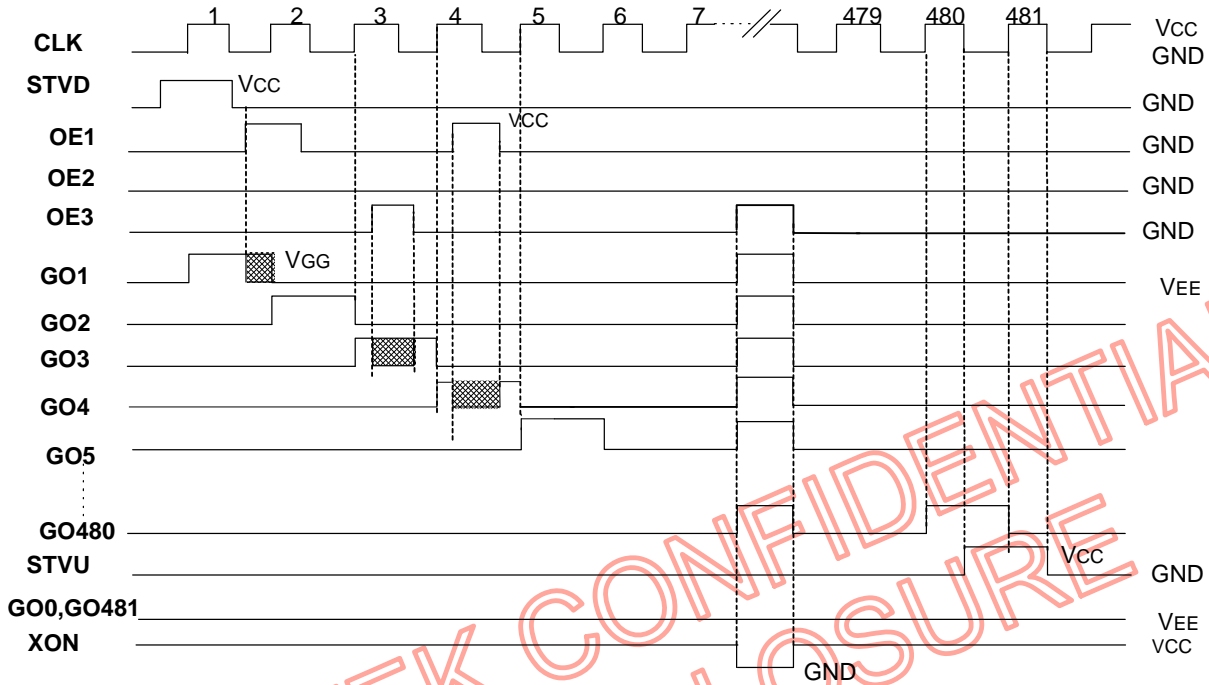
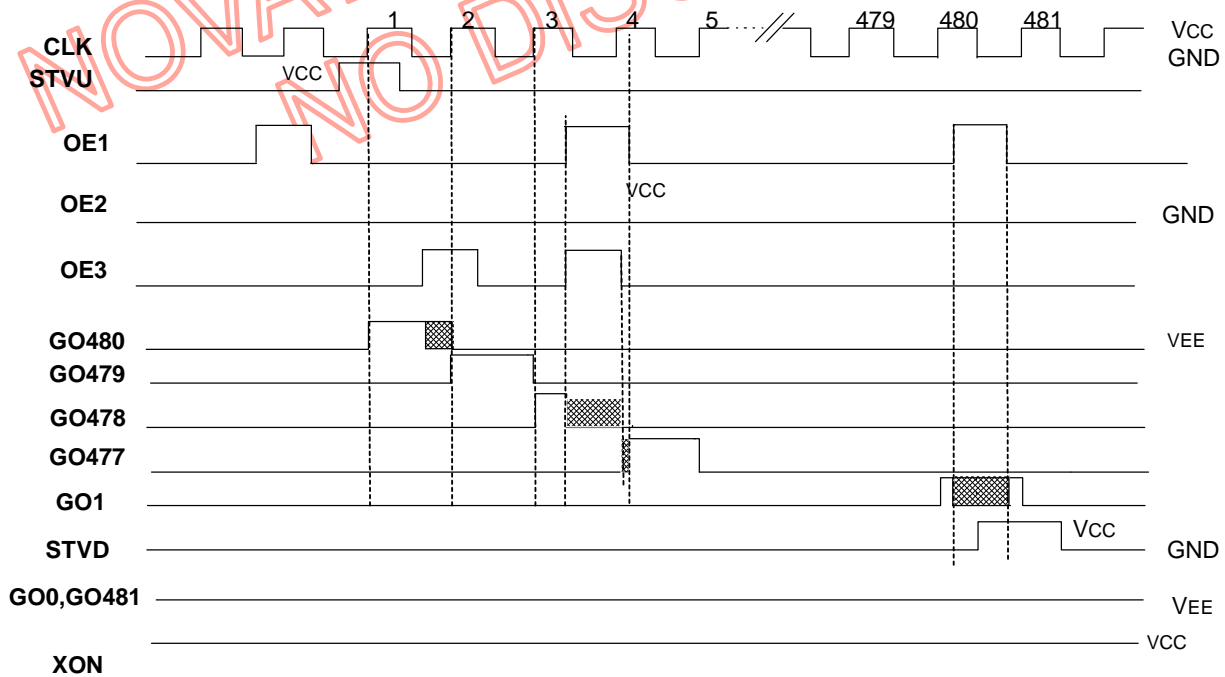
**Operation( long start pulse )(3CKV)**

**Operation(3 OE)**
**1. U\_D = 'H'**

**2. U\_D = 'L'**

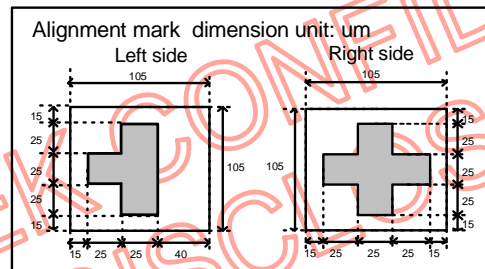
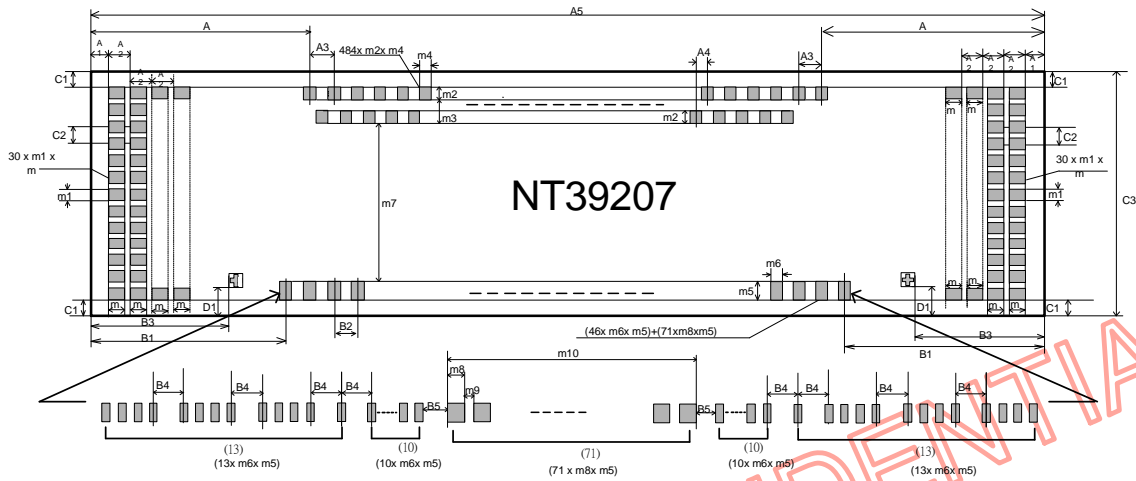
 : Deleted from normal output by OEx

**Chip Outline Dimensions**

Symbol	Dimensions in um	Symbol	Dimensions in um
A	710	D1	105
A1	70	m	50
A2	65	m1	45
A3	50	m2	84
A4	25	m3	119
A5	13520	m4	25
B1	666	m5	85
B2	52	m6	40
B3	440	m7	609
B4	80	m8	105
B5	40.5	m9	30
C1	70	m10	9555
C2	71		
C3	1037		

## Bonding Diagram

No.	TextName	CX	CY	No.	TextName	CX	CY	No.	TextName	CX	CY
1	XONL	-6665	426	41	VCCL	-5518	-406	81	DUMMY[28]	-1080	-406
2	XONL	-6600	426	42	VCCL	-5466	-406	82	DUMMY[29]	-945	-406
3	XONL	-6535	426	43	MODEL	-5386	-406	83	DUMMY[30]	-810	-406
4	XONL	-6470	426	44	GNDL	-5306	-406	84	DUMMY[31]	-675	-406
5	OE1L	-6665	355	45	GNDL	-5254	-406	85	DUMMY[32]	-540	-406
6	OE1L	-6600	355	46	GNDL	-5202	-406	86	DUMMY[33]	-405	-406
7	OE2L	-6665	284	47	GNDL	-5150	-406	87	DUMMY[34]	-270	-406
8	OE2L	-6600	284	48	GNDL	-5098	-406	88	DUMMY[35]	-135	-406
9	OE3L	-6665	213	49	GNDL	-5046	-406	89	DUMMY[36]	0	-406
10	OE3L	-6600	213	50	GNDL	-4994	-406	90	DUMMY[37]	135	-406
11	U/DL	-6665	142	51	GNDL	-4942	-406	91	DUMMY[38]	270	-406
12	U/DL	-6600	142	52	GNDL	-4890	-406	92	DUMMY[39]	405	-406
13	CLKL	-6665	71	53	GNDL	-4838	-406	93	DUMMY[40]	540	-406
14	CLKL	-6600	71	54	DUMMY[1]	-4725	-406	94	DUMMY[41]	675	-406
15	PATHL	-6665	0	55	DUMMY[2]	-4590	-406	95	DUMMY[42]	810	-406
16	PATHL	-6600	0	56	DUMMY[3]	-4455	-406	96	DUMMY[43]	945	-406
17	STVU	-6665	-71	57	DUMMY[4]	-4320	-406	97	DUMMY[44]	1080	-406
18	STVU	-6600	-71	58	DUMMY[5]	-4185	-406	98	DUMMY[45]	1215	-406
19	VGGL	-6665	-142	59	DUMMY[6]	-4050	-406	99	DUMMY[46]	1350	-406
20	VGGL	-6600	-142	60	DUMMY[7]	-3915	-406	100	DUMMY[47]	1485	-406
21	VGGL	-6665	-213	61	DUMMY[8]	-3780	-406	101	DUMMY[48]	1620	-406
22	VGGL	-6600	-213	62	DUMMY[9]	-3645	-406	102	DUMMY[49]	1755	-406
23	VCCL	-6665	-284	63	DUMMY[10]	-3510	-406	103	DUMMY[50]	1890	-406
24	VCCL	-6600	-284	64	DUMMY[11]	-3375	-406	104	DUMMY[51]	2025	-406
25	VCCL	-6665	-355	65	DUMMY[12]	-3240	-406	105	DUMMY[52]	2160	-406
26	VCCL	-6600	-355	66	DUMMY[13]	-3105	-406	106	DUMMY[53]	2295	-406
27	MODEL	-6665	-426	67	DUMMY[14]	-2970	-406	107	DUMMY[54]	2430	-406
28	MODEL	-6600	-426	68	DUMMY[15]	-2835	-406	108	DUMMY[55]	2565	-406
29	MODEL	-6535	-426	69	DUMMY[16]	-2700	-406	109	DUMMY[56]	2700	-406
30	MODEL	-6470	-426	70	DUMMY[17]	-2565	-406	110	DUMMY[57]	2835	-406
31	VEEL	-6094	-406	71	DUMMY[18]	-2430	-406	111	DUMMY[58]	2970	-406
32	VEEL	-6042	-406	72	DUMMY[19]	-2295	-406	112	DUMMY[59]	3105	-406
33	VEEL	-5990	-406	73	DUMMY[20]	-2160	-406	113	DUMMY[60]	3240	-406
34	VEEL	-5938	-406	74	DUMMY[21]	-2025	-406	114	DUMMY[61]	3375	-406
35	VGGL	-5858	-406	75	DUMMY[22]	-1890	-406	115	DUMMY[62]	3510	-406
36	VGGL	-5806	-406	76	DUMMY[23]	-1755	-406	116	DUMMY[63]	3645	-406
37	VGGL	-5754	-406	77	DUMMY[24]	-1620	-406	117	DUMMY[64]	3780	-406
38	VGGL	-5702	-406	78	DUMMY[25]	-1485	-406	118	DUMMY[65]	3915	-406
39	VCCL	-5622	-406	79	DUMMY[26]	-1350	-406	119	DUMMY[66]	4050	-406
40	VCCL	-5570	-406	80	DUMMY[27]	-1215	-406	120	DUMMY[67]	4185	-406

No.	TextName	CX	CY
121	DUMMY[68]	4320	-406
122	DUMMY[69]	4455	-406
123	DUMMY[70]	4590	-406
124	DUMMY[71]	4725	-406
125	GNDR	4838	-406
126	GNDR	4890	-406
127	GNDR	4942	-406
128	GNDR	4994	-406
129	GNDR	5046	-406
130	GNDR	5098	-406
131	GNDR	5150	-406
132	GNDR	5202	-406
133	GNDR	5254	-406
134	GNDR	5306	-406
135	MODER	5386	-406
136	VCCR	5622	-406
137	VCCR	5570	-406
138	VCCR	5518	-406
139	VCCR	5466	-406
140	VGGR	5858	-406
141	VGGR	5806	-406
142	VGGR	5754	-406
143	VGGR	5702	-406
144	VEER	6094	-406
145	VEER	6042	-406
146	VEER	5990	-406
147	VEER	5938	-406
148	MODER	6470	-426
149	MODER	6535	-426
150	MODER	6600	-426
151	MODER	6665	-426
152	VCCR	6665	-355
153	VCCR	6600	-355
154	VCCR	6665	-284
155	VCCR	6600	-284
156	VGGR	6665	-213
157	VGGR	6600	-213
158	VGGR	6665	-142
159	VGGR	6600	-142
160	STVD	6665	-71

No.	TextName	CX	CY
161	STVD	6600	-71
162	PATHR	6665	0
163	PATHR	6600	0
164	CLKR	6665	71
165	CLKR	6600	71
166	U/DR	6665	142
167	U/DR	6600	142
168	OE3R	6665	213
169	OE3R	6600	213
170	OE2R	6665	284
171	OE2R	6600	284
172	OE1R	6665	355
173	OE1R	6600	355
174	XONR	6665	426
175	XONR	6600	426
176	XONR	6535	426
177	XONR	6470	426
178	DUMMY[72]	6050	406.5
179	G[0]	6000	406.5
180	G[1]	5975	287.5
181	G[2]	5950	406.5
182	G[3]	5925	287.5
183	G[4]	5900	406.5
184	G[5]	5875	287.5
185	G[6]	5850	406.5
186	G[7]	5825	287.5
187	G[8]	5800	406.5
188	G[9]	5775	287.5
189	G[10]	5750	406.5
190	G[11]	5725	287.5
191	G[12]	5700	406.5
192	G[13]	5675	287.5
193	G[14]	5650	406.5
194	G[15]	5625	287.5
195	G[16]	5600	406.5
196	G[17]	5575	287.5
197	G[18]	5550	406.5
198	G[19]	5525	287.5
199	G[20]	5500	406.5
200	G[21]	5475	287.5

No.	TextName	CX	CY
201	G[22]	5450	406.5
202	G[23]	5425	287.5
203	G[24]	5400	406.5
204	G[25]	5375	287.5
205	G[26]	5350	406.5
206	G[27]	5325	287.5
207	G[28]	5300	406.5
208	G[29]	5275	287.5
209	G[30]	5250	406.5
210	G[31]	5225	287.5
211	G[32]	5200	406.5
212	G[33]	5175	287.5
213	G[34]	5150	406.5
214	G[35]	5125	287.5
215	G[36]	5100	406.5
216	G[37]	5075	287.5
217	G[38]	5050	406.5
218	G[39]	5025	287.5
219	G[40]	5000	406.5
220	G[41]	4975	287.5
221	G[42]	4950	406.5
222	G[43]	4925	287.5
223	G[44]	4900	406.5
224	G[45]	4875	287.5
225	G[46]	4850	406.5
226	G[47]	4825	287.5
227	G[48]	4800	406.5
228	G[49]	4775	287.5
229	G[50]	4750	406.5
230	G[51]	4725	287.5
231	G[52]	4700	406.5
232	G[53]	4675	287.5
233	G[54]	4650	406.5
234	G[55]	4625	287.5
235	G[56]	4600	406.5
236	G[57]	4575	287.5
237	G[58]	4550	406.5
238	G[59]	4525	287.5
239	G[60]	4500	406.5
240	G[61]	4475	287.5

No.	TextName	CX	CY	No.	TextName	CX	CY	No.	TextName	CX	CY
241	G[62]	4450	406.5	281	G[102]	3450	406.5	321	G[142]	2450	406.5
242	G[63]	4425	287.5	282	G[103]	3425	287.5	322	G[143]	2425	287.5
243	G[64]	4400	406.5	283	G[104]	3400	406.5	323	G[144]	2400	406.5
244	G[65]	4375	287.5	284	G[105]	3375	287.5	324	G[145]	2375	287.5
245	G[66]	4350	406.5	285	G[106]	3350	406.5	325	G[146]	2350	406.5
246	G[67]	4325	287.5	286	G[107]	3325	287.5	326	G[147]	2325	287.5
247	G[68]	4300	406.5	287	G[108]	3300	406.5	327	G[148]	2300	406.5
248	G[69]	4275	287.5	288	G[109]	3275	287.5	328	G[149]	2275	287.5
249	G[70]	4250	406.5	289	G[110]	3250	406.5	329	G[150]	2250	406.5
250	G[71]	4225	287.5	290	G[111]	3225	287.5	330	G[151]	2225	287.5
251	G[72]	4200	406.5	291	G[112]	3200	406.5	331	G[152]	2200	406.5
252	G[73]	4175	287.5	292	G[113]	3175	287.5	332	G[153]	2175	287.5
253	G[74]	4150	406.5	293	G[114]	3150	406.5	333	G[154]	2150	406.5
254	G[75]	4125	287.5	294	G[115]	3125	287.5	334	G[155]	2125	287.5
255	G[76]	4100	406.5	295	G[116]	3100	406.5	335	G[156]	2100	406.5
256	G[77]	4075	287.5	296	G[117]	3075	287.5	336	G[157]	2075	287.5
257	G[78]	4050	406.5	297	G[118]	3050	406.5	337	G[158]	2050	406.5
258	G[79]	4025	287.5	298	G[119]	3025	287.5	338	G[159]	2025	287.5
259	G[80]	4000	406.5	299	G[120]	3000	406.5	339	G[160]	2000	406.5
260	G[81]	3975	287.5	300	G[121]	2975	287.5	340	G[161]	1975	287.5
261	G[82]	3950	406.5	301	G[122]	2950	406.5	341	G[162]	1950	406.5
262	G[83]	3925	287.5	302	G[123]	2925	287.5	342	G[163]	1925	287.5
263	G[84]	3900	406.5	303	G[124]	2900	406.5	343	G[164]	1900	406.5
264	G[85]	3875	287.5	304	G[125]	2875	287.5	344	G[165]	1875	287.5
265	G[86]	3850	406.5	305	G[126]	2850	406.5	345	G[166]	1850	406.5
266	G[87]	3825	287.5	306	G[127]	2825	287.5	346	G[167]	1825	287.5
267	G[88]	3800	406.5	307	G[128]	2800	406.5	347	G[168]	1800	406.5
268	G[89]	3775	287.5	308	G[129]	2775	287.5	348	G[169]	1775	287.5
269	G[90]	3750	406.5	309	G[130]	2750	406.5	349	G[170]	1750	406.5
270	G[91]	3725	287.5	310	G[131]	2725	287.5	350	G[171]	1725	287.5
271	G[92]	3700	406.5	311	G[132]	2700	406.5	351	G[172]	1700	406.5
272	G[93]	3675	287.5	312	G[133]	2675	287.5	352	G[173]	1675	287.5
273	G[94]	3650	406.5	313	G[134]	2650	406.5	353	G[174]	1650	406.5
274	G[95]	3625	287.5	314	G[135]	2625	287.5	354	G[175]	1625	287.5
275	G[96]	3600	406.5	315	G[136]	2600	406.5	355	G[176]	1600	406.5
276	G[97]	3575	287.5	316	G[137]	2575	287.5	356	G[177]	1575	287.5
277	G[98]	3550	406.5	317	G[138]	2550	406.5	357	G[178]	1550	406.5
278	G[99]	3525	287.5	318	G[139]	2525	287.5	358	G[179]	1525	287.5
279	G[100]	3500	406.5	319	G[140]	2500	406.5	359	G[180]	1500	406.5
280	G[101]	3475	287.5	320	G[141]	2475	287.5	360	G[181]	1475	287.5

No.	TextName	CX	CY
361	G[182]	1450	406.5
362	G[183]	1425	287.5
363	G[184]	1400	406.5
364	G[185]	1375	287.5
365	G[186]	1350	406.5
366	G[187]	1325	287.5
367	G[188]	1300	406.5
368	G[189]	1275	287.5
369	G[190]	1250	406.5
370	G[191]	1225	287.5
371	G[192]	1200	406.5
372	G[193]	1175	287.5
373	G[194]	1150	406.5
374	G[195]	1125	287.5
375	G[196]	1100	406.5
376	G[197]	1075	287.5
377	G[198]	1050	406.5
378	G[199]	1025	287.5
379	G[200]	1000	406.5
380	G[201]	975	287.5
381	G[202]	950	406.5
382	G[203]	925	287.5
383	G[204]	900	406.5
384	G[205]	875	287.5
385	G[206]	850	406.5
386	G[207]	825	287.5
387	G[208]	800	406.5
388	G[209]	775	287.5
389	G[210]	750	406.5
390	G[211]	725	287.5
391	G[212]	700	406.5
392	G[213]	675	287.5
393	G[214]	650	406.5
394	G[215]	625	287.5
395	G[216]	600	406.5
396	G[217]	575	287.5
397	G[218]	550	406.5
398	G[219]	525	287.5
399	G[220]	500	406.5
400	G[221]	475	287.5

No.	TextName	CX	CY
401	G[222]	450	406.5
402	G[223]	425	287.5
403	G[224]	400	406.5
404	G[225]	375	287.5
405	G[226]	350	406.5
406	G[227]	325	287.5
407	G[228]	300	406.5
408	G[229]	275	287.5
409	G[230]	250	406.5
410	G[231]	225	287.5
411	G[232]	200	406.5
412	G[233]	175	287.5
413	G[234]	150	406.5
414	G[235]	125	287.5
415	G[236]	100	406.5
416	G[237]	75	287.5
417	G[238]	50	406.5
418	G[239]	25	287.5
419	G[240]	0	406.5
420	G[241]	-25	287.5
421	G[242]	-50	406.5
422	G[243]	-75	287.5
423	G[244]	-100	406.5
424	G[245]	-125	287.5
425	G[246]	-150	406.5
426	G[247]	-175	287.5
427	G[248]	-200	406.5
428	G[249]	-225	287.5
429	G[250]	-250	406.5
430	G[251]	-275	287.5
431	G[252]	-300	406.5
432	G[253]	-325	287.5
433	G[254]	-350	406.5
434	G[255]	-375	287.5
435	G[256]	-400	406.5
436	G[257]	-425	287.5
437	G[258]	-450	406.5
438	G[259]	-475	287.5
439	G[260]	-500	406.5
440	G[261]	-525	287.5

No.	TextName	CX	CY
441	G[262]	-550	406.5
442	G[263]	-575	287.5
443	G[264]	-600	406.5
444	G[265]	-625	287.5
445	G[266]	-650	406.5
446	G[267]	-675	287.5
447	G[268]	-700	406.5
448	G[269]	-725	287.5
449	G[270]	-750	406.5
450	G[271]	-775	287.5
451	G[272]	-800	406.5
452	G[273]	-825	287.5
453	G[274]	-850	406.5
454	G[275]	-875	287.5
455	G[276]	-900	406.5
456	G[277]	-925	287.5
457	G[278]	-950	406.5
458	G[279]	-975	287.5
459	G[280]	-1000	406.5
460	G[281]	-1025	287.5
461	G[282]	-1050	406.5
462	G[283]	-1075	287.5
463	G[284]	-1100	406.5
464	G[285]	-1125	287.5
465	G[286]	-1150	406.5
466	G[287]	-1175	287.5
467	G[288]	-1200	406.5
468	G[289]	-1225	287.5
469	G[290]	-1250	406.5
470	G[291]	-1275	287.5
471	G[292]	-1300	406.5
472	G[293]	-1325	287.5
473	G[294]	-1350	406.5
474	G[295]	-1375	287.5
475	G[296]	-1400	406.5
476	G[297]	-1425	287.5
477	G[298]	-1450	406.5
478	G[299]	-1475	287.5
479	G[300]	-1500	406.5
480	G[301]	-1525	287.5



No.	TextName	CX	CY	No.	TextName	CX	CY	No.	TextName	CX	CY
481	G[302]	-1550	406.5	521	G[342]	-2550	406.5	561	G[382]	-3550	406.5
482	G[303]	-1575	287.5	522	G[343]	-2575	287.5	562	G[383]	-3575	287.5
483	G[304]	-1600	406.5	523	G[344]	-2600	406.5	563	G[384]	-3600	406.5
484	G[305]	-1625	287.5	524	G[345]	-2625	287.5	564	G[385]	-3625	287.5
485	G[306]	-1650	406.5	525	G[346]	-2650	406.5	565	G[386]	-3650	406.5
486	G[307]	-1675	287.5	526	G[347]	-2675	287.5	566	G[387]	-3675	287.5
487	G[308]	-1700	406.5	527	G[348]	-2700	406.5	567	G[388]	-3700	406.5
488	G[309]	-1725	287.5	528	G[349]	-2725	287.5	568	G[389]	-3725	287.5
489	G[310]	-1750	406.5	529	G[350]	-2750	406.5	569	G[390]	-3750	406.5
490	G[311]	-1775	287.5	530	G[351]	-2775	287.5	570	G[391]	-3775	287.5
491	G[312]	-1800	406.5	531	G[352]	-2800	406.5	571	G[392]	-3800	406.5
492	G[313]	-1825	287.5	532	G[353]	-2825	287.5	572	G[393]	-3825	287.5
493	G[314]	-1850	406.5	533	G[354]	-2850	406.5	573	G[394]	-3850	406.5
494	G[315]	-1875	287.5	534	G[355]	-2875	287.5	574	G[395]	-3875	287.5
495	G[316]	-1900	406.5	535	G[356]	-2900	406.5	575	G[396]	-3900	406.5
496	G[317]	-1925	287.5	536	G[357]	-2925	287.5	576	G[397]	-3925	287.5
497	G[318]	-1950	406.5	537	G[358]	-2950	406.5	577	G[398]	-3950	406.5
498	G[319]	-1975	287.5	538	G[359]	-2975	287.5	578	G[399]	-3975	287.5
499	G[320]	-2000	406.5	539	G[360]	-3000	406.5	579	G[400]	-4000	406.5
500	G[321]	-2025	287.5	540	G[361]	-3025	287.5	580	G[401]	-4025	287.5
501	G[322]	-2050	406.5	541	G[362]	-3050	406.5	581	G[402]	-4050	406.5
502	G[323]	-2075	287.5	542	G[363]	-3075	287.5	582	G[403]	-4075	287.5
503	G[324]	-2100	406.5	543	G[364]	-3100	406.5	583	G[404]	-4100	406.5
504	G[325]	-2125	287.5	544	G[365]	-3125	287.5	584	G[405]	-4125	287.5
505	G[326]	-2150	406.5	545	G[366]	-3150	406.5	585	G[406]	-4150	406.5
506	G[327]	-2175	287.5	546	G[367]	-3175	287.5	586	G[407]	-4175	287.5
507	G[328]	-2200	406.5	547	G[368]	-3200	406.5	587	G[408]	-4200	406.5
508	G[329]	-2225	287.5	548	G[369]	-3225	287.5	588	G[409]	-4225	287.5
509	G[330]	-2250	406.5	549	G[370]	-3250	406.5	589	G[410]	-4250	406.5
510	G[331]	-2275	287.5	550	G[371]	-3275	287.5	590	G[411]	-4275	287.5
511	G[332]	-2300	406.5	551	G[372]	-3300	406.5	591	G[412]	-4300	406.5
512	G[333]	-2325	287.5	552	G[373]	-3325	287.5	592	G[413]	-4325	287.5
513	G[334]	-2350	406.5	553	G[374]	-3350	406.5	593	G[414]	-4350	406.5
514	G[335]	-2375	287.5	554	G[375]	-3375	287.5	594	G[415]	-4375	287.5
515	G[336]	-2400	406.5	555	G[376]	-3400	406.5	595	G[416]	-4400	406.5
516	G[337]	-2425	287.5	556	G[377]	-3425	287.5	596	G[417]	-4425	287.5
517	G[338]	-2450	406.5	557	G[378]	-3450	406.5	597	G[418]	-4450	406.5
518	G[339]	-2475	287.5	558	G[379]	-3475	287.5	598	G[419]	-4475	287.5
519	G[340]	-2500	406.5	559	G[380]	-3500	406.5	599	G[420]	-4500	406.5
520	G[341]	-2525	287.5	560	G[381]	-3525	287.5	600	G[421]	-4525	287.5

No.	TextName	CX	CY	No.	TextName	CX	CY
601	G[422]	-4550	406.5	641	G[462]	-5550	406.5
602	G[423]	-4575	287.5	642	G[463]	-5575	287.5
603	G[424]	-4600	406.5	643	G[464]	-5600	406.5
604	G[425]	-4625	287.5	644	G[465]	-5625	287.5
605	G[426]	-4650	406.5	645	G[466]	-5650	406.5
606	G[427]	-4675	287.5	646	G[467]	-5675	287.5
607	G[428]	-4700	406.5	647	G[468]	-5700	406.5
608	G[429]	-4725	287.5	648	G[469]	-5725	287.5
609	G[430]	-4750	406.5	649	G[470]	-5750	406.5
610	G[431]	-4775	287.5	650	G[471]	-5775	287.5
611	G[432]	-4800	406.5	651	G[472]	-5800	406.5
612	G[433]	-4825	287.5	652	G[473]	-5825	287.5
613	G[434]	-4850	406.5	653	G[474]	-5850	406.5
614	G[435]	-4875	287.5	654	G[475]	-5875	287.5
615	G[436]	-4900	406.5	655	G[476]	-5900	406.5
616	G[437]	-4925	287.5	656	G[477]	-5925	287.5
617	G[438]	-4950	406.5	657	G[478]	-5950	406.5
618	G[439]	-4975	287.5	658	G[479]	-5975	287.5
619	G[440]	-5000	406.5	659	G[480]	-6000	406.5
620	G[441]	-5025	287.5	660	G[481]	-6025	287.5
621	G[442]	-5050	406.5	661	DUMMY[73]	-6050	406.5
622	G[443]	-5075	287.5				
623	G[444]	-5100	406.5				
624	G[445]	-5125	287.5				
625	G[446]	-5150	406.5				
626	G[447]	-5175	287.5				
627	G[448]	-5200	406.5				
628	G[449]	-5225	287.5				
629	G[450]	-5250	406.5				
630	G[451]	-5275	287.5				
631	G[452]	-5300	406.5				
632	G[453]	-5325	287.5				
633	G[454]	-5350	406.5				
634	G[455]	-5375	287.5				
635	G[456]	-5400	406.5				
636	G[457]	-5425	287.5				
637	G[458]	-5450	406.5				
638	G[459]	-5475	287.5				
639	G[460]	-5500	406.5				
640	G[461]	-5525	287.5				

NOVATEK CONFIDENTIAL DISCLOSURE

### Application Notes

1. MODE = "H", channel number =480 (MODE pin connect to VCC)

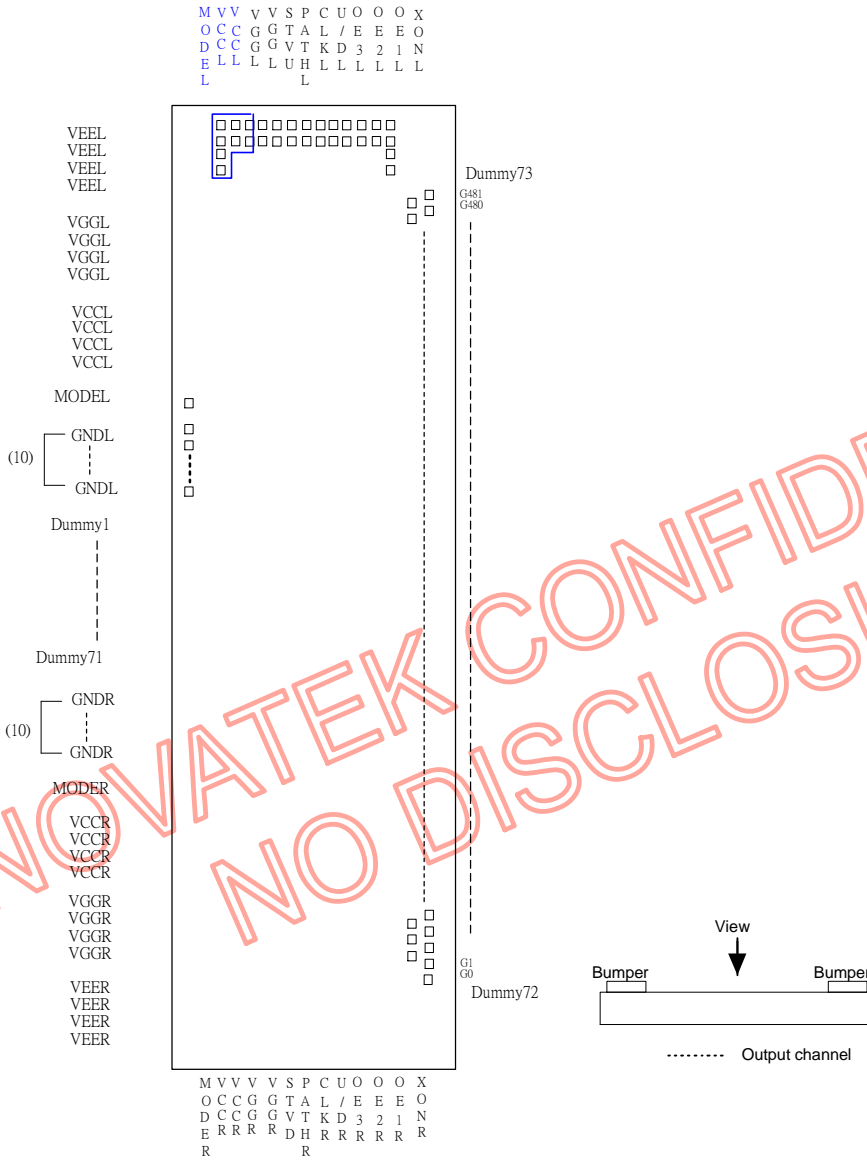

NOVATEK CONFIDENTIAL  
NO DISCLOSURE

2. MODE = "L", channel number =320 ( MODE pin connect to GND)

