



ORIENT DISPLAY

Your Total LCD Solution Provider

Specification for TFT

AFC1024600A0-7.0INTM-I

Revision D



A	Orient Display
FC	TFT Type
1024600	Resolution 1024 x 600
A0	Serial A0
7.0	7.0", Module Dimension 164.90 x 100.00 x 2.80 mm
I	IPS Display
N	Top: -20~+70°C; Tstr: -30~+80°C
T	Transmissive
M	Medium Brightness, 500 cd/m2
I	MIPI Interface
/	No Touch Panel
/	Controller HX8282-A11+HX8696-A01 or compatible



Revision History

Date	Rev.	Description	Note	Page
2021-12-10	A	New issue	Zheng jialong	

Contents

1. Features.....	4
2. Mechanical Specifications	4
3. Absolute Maximum Ratings	4
4. DC Electrical Characteristics	5
5. Optical Characteristics	5
6. Backlight Characteristics	9
7. Touch Characteristics	9
8. Interface Pin Description	10
9. Block Diagram of display	11
10. Counter drawing	12
11. Timing Characteristics.....	12
12. Reliability.....	12
13. Specification of Quality Assurance.....	13
14. Package Specification.....	19
15. Precaution for Using LCD Module.....	19

1. Features

Item	Standard Value
Display Type	1024(RGB)*600 Dots
LCD Type	Color TFT, Transmissive
Screen Size(inch)	7.0
Viewing Direction	ALL
Backlight	White
Weight	About 90.25g
Interface	LVDS
Other(controller/driver IC)	HX8282-A11+HX8696-A01

2. Mechanical Specifications

Item	Standard Value	Unit
Outline Dimension	164.90(L)*100.00(W)*2.80(T)	mm
Active Area	154.21(L)*85.92(W)	mm
Dots Pitch	0.1506(L)*0.143.2(W)	mm

3. Absolute Maximum Ratings

Item	Symbol	Condition	Min.	Max.	Unit
Power Supply Voltage(I/O)	V _{DDI}	-	-0.5	3.96	V
Logic Input Voltage	V _{IN}	-	-0.5	5.0	V
Logic Output Voltage	V _O	-	-0.5	V _{DDI} +0.5	V
Operating Temperature	T _{OP}	-	-20	70	°C
Storage Temperature	T _{ST}	-	-30	80	°C
Humidity	-	T _A ≤ 60°C	-	90	RH

4. DC Electrical Characteristics

Item	Symbol	Condition	Min.	Typ.	Max.	Unit
Interface Voltage	V _{DDI}	I/O Supply Voltage	2.3	3.3	3.6	V
“H” Input Voltage	V _{IH}	-	0.7V _{DDI}	--	V _{DDI}	V
“L” Input Voltage	V _{IL}	-	V _{SS}	--	0.3V _{DDI}	V
“H” Output Voltage	V _{OH}	I _{OH} = -1.0mA	V _{DDI} -0.4	--	V _{DDI}	V
“L” Output Voltage	V _{OL}	I _{OL} = +1.0mA	V _{SS}	--	V _{SS} +0.4	V
Supply Current	I _{DD}	Normal	--	18	23	mA
		Stand-by	--	10	50	uA
Power for Analog circuit	AV _{DD}	--	--	9.6	--	V
TFT gate on voltage	V _{GH}	--	--	18	--	V
TFT gate off voltage	V _{GL}	--	--	-6	--	V
TFT common electrode voltage	V _{com}	-	3.1	--	3.3	V
TFT operation frame rate	Hz	-	--	60	--	Hz

5. Optical Characteristics

Item	Symbol	Conditions	Min.	Typ.	Max.	Reference
View Angle	Top	Θ _y +	--	85	--	Notes 1 & 2
	Bottom	Θ _y -	--	85	--	
	Left	Θ _x +	--	85	--	
	Right	Θ _x -	--	85	--	
CIE *1	White	X	0.275	0.305	0.335	Notes 5
		Y	0.293	0.323	0.353	
	Red	X	0.576	0.606	0.636	
		Y	0.320	0.350	0.380	
	Green	X	0.305	0.335	0.365	
		Y	0.524	0.554	0.584	
	Blue	X	0.120	0.150	0.180	
		Y	0.085	0.115	0.145	
Uniformity	--	--	75%	--	--	Note 4
Contrast Ratio	Cr	θ _Y = 5°, Ø = 0°	--	800	--	Note 3
Surface Brightness	L	Ø = 0°	400	500	--	Note 3 & 4
NTSC	-	--	--	50%	--	-
Response Time	TR+TF	Ø = 0°	--	30	40	Note 2

*1: This value will be changed while mass product.

Note 1.

Optical characteristics-2

Viewing angle

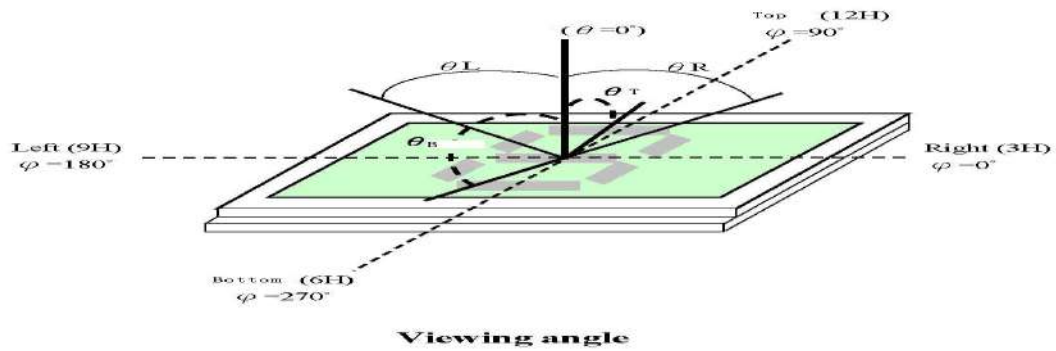

Note 2.

Optical characteristics-3

Fig.2 Definition of response time

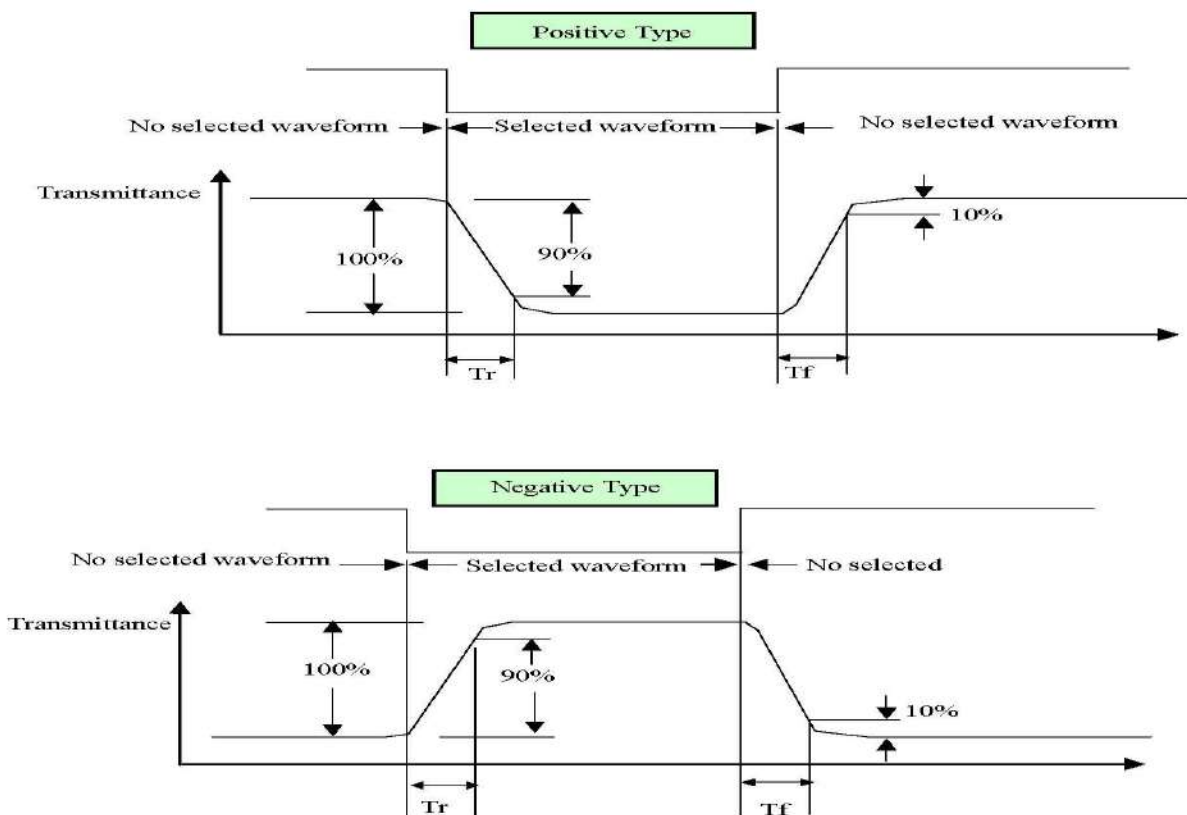

Electrical characteristics-2

※2 Drive waveform

V_{op} : Drive voltage f_F : Frame frequency

$1/B$: Bias f_D : Drive frequency

N : Duty

(1) Selected waveform

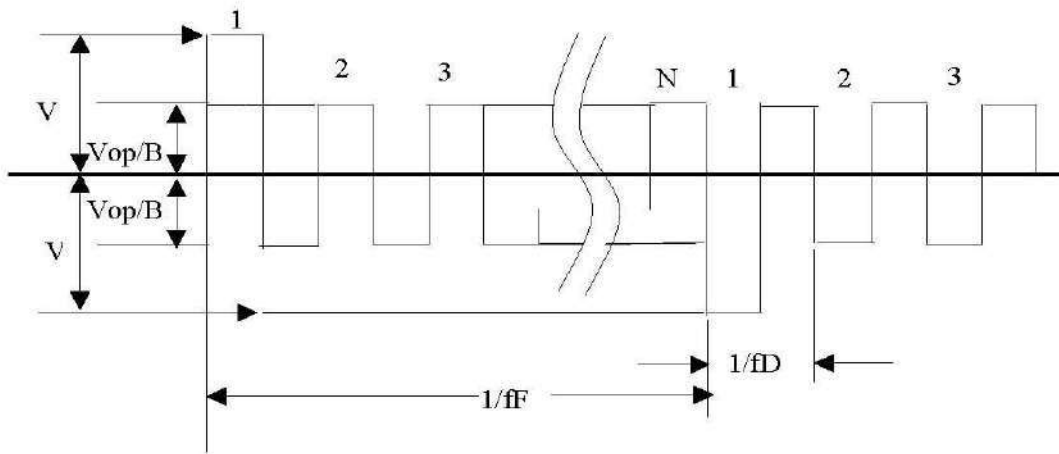

(2) Non- Selected wave form

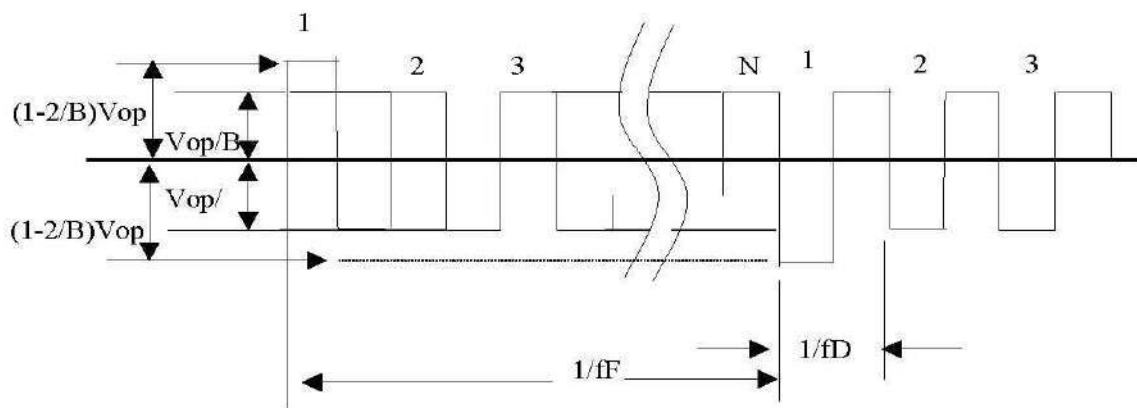

Note:

Frame frequency is defined as follows: Common side supply
voltage peak - to - peak / 2 = 1 period

Note 3. : Definition of Vth

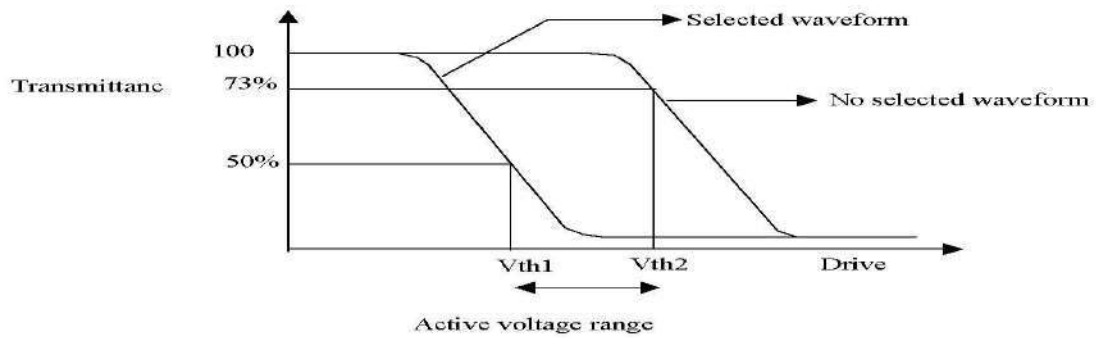

	Vth1	Vth2
View direction	10°	40°
Drive waveform	(Selected waveform)	(No selected waveform)
Transmittance	50%	73%

※1 Contrast ratio
 = (Brightness in OFF state) / (Brightness in ON state)

Outline of Electro-Optical Characteristics Measuring System

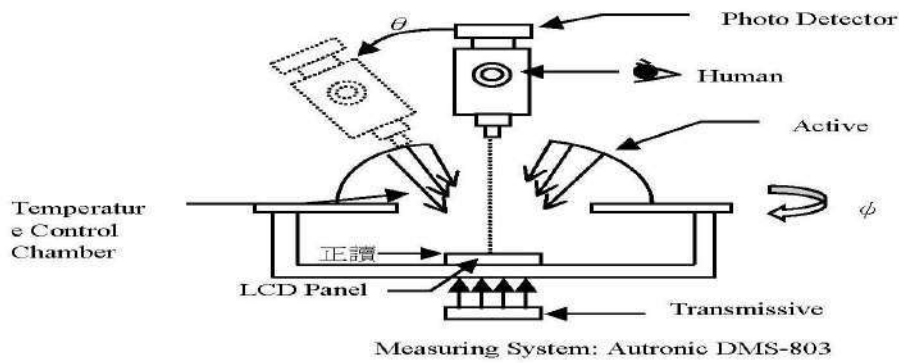

Note 4. Definition of Surface Luminance, Uniformity. (Ref Fig1)

Surface Luminance: LV=average (LP1:LP9)

Uniformity=Minimal (LP1:LP9)/Maximal (LP1:LP9)*100%

Color Coordinate: The test condition is at IF current of backlight and measured on the surface of LCD module.

Note 5. CIE(x, y) chromaticity is the Center point value. (Ref Fig1)

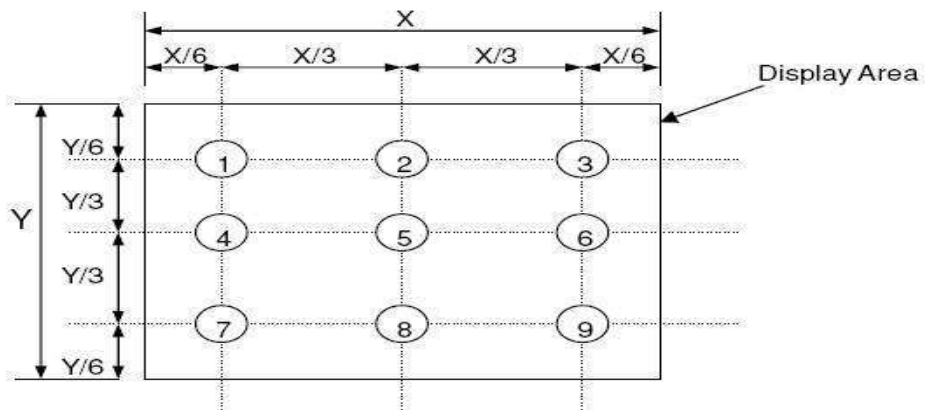

Fig1

6. Backlight Characteristics

Item	Symbol	Conditions	Min.	Typ.	Max.	Unit
Forward Voltage(ten LED)	V_F	$I_F=160\text{mA}$	8.1	9.6	10.2	V
Forward Current	I_F	--	--	--	--	mA
LED Life time (50% initial brightness)	$T_a=25^\circ\text{C}$, $I_F=160\text{mA}$		20000H minimum			
Color	White					

7. Touch Panel Characteristics

TBD

8. Interface Pin Description

Pin No.	Symbol	Function
1	VCOM	VCOM VOLTAGE
2	VDD	Digital Power
3	VDD	Digital Power
4	NC	No Connection
5	Reset	System reset
6	STBYB	Standby
7	GND	Ground
8	RX0-	LVDS Data Bus
9	RX0+	LVDS Data Bus
10	GND	Ground
11	RX1-	LVDS Data Bus
12	RX1+	LVDS Data Bus
13	GND	Ground
14	RX2-	LVDS Data Bus
15	RX2+	LVDS Data Bus
16	GND	Ground
17	RXCLK-	LVDS Data Bus
18	RXCLK+	LVDS Data Bus
19	GND	Ground
20	RX3-	LVDS Data Bus
21	RX3+	LVDS Data Bus
22	GND	Ground
23	NC	No Connection
24	NC	No Connection
25	GND	Ground

26	NC	No Connection
27	DIMO	Brightness control signal output,OPEN
28	SELB	No Connection
29	AVDD	Analog power supply
30	GND	Ground
31	LED-	Backlight Cathode
32	LED-	Backlight Cathode
33	L/R	No Connection
34	U/D	No Connection
35	VGL	Gate off voltage
36	CABCEN1	No Connection
37	CABCEN0	No Connection
38	VGH	Gate on voltage
39	LED+	Backlight Anode
40	LED+	Backlight Anode

9. Block Diagram of Display

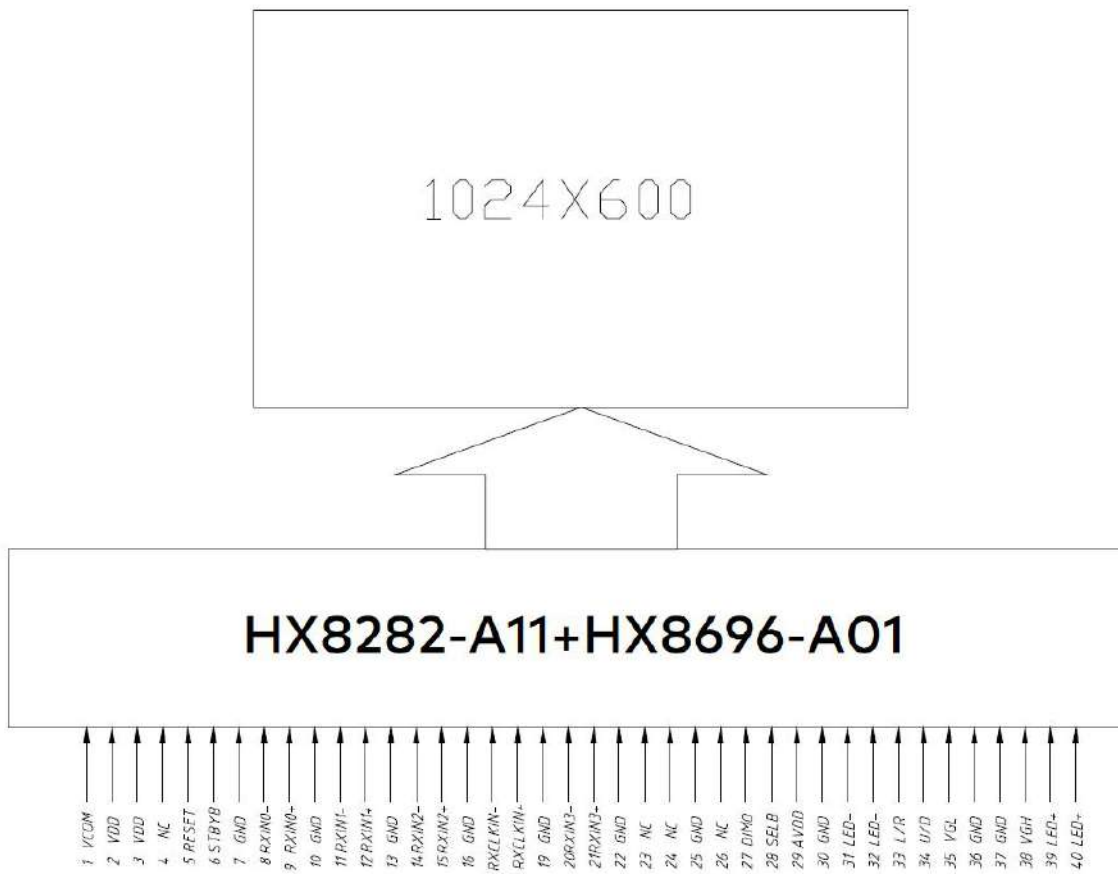

10. Count Drawing

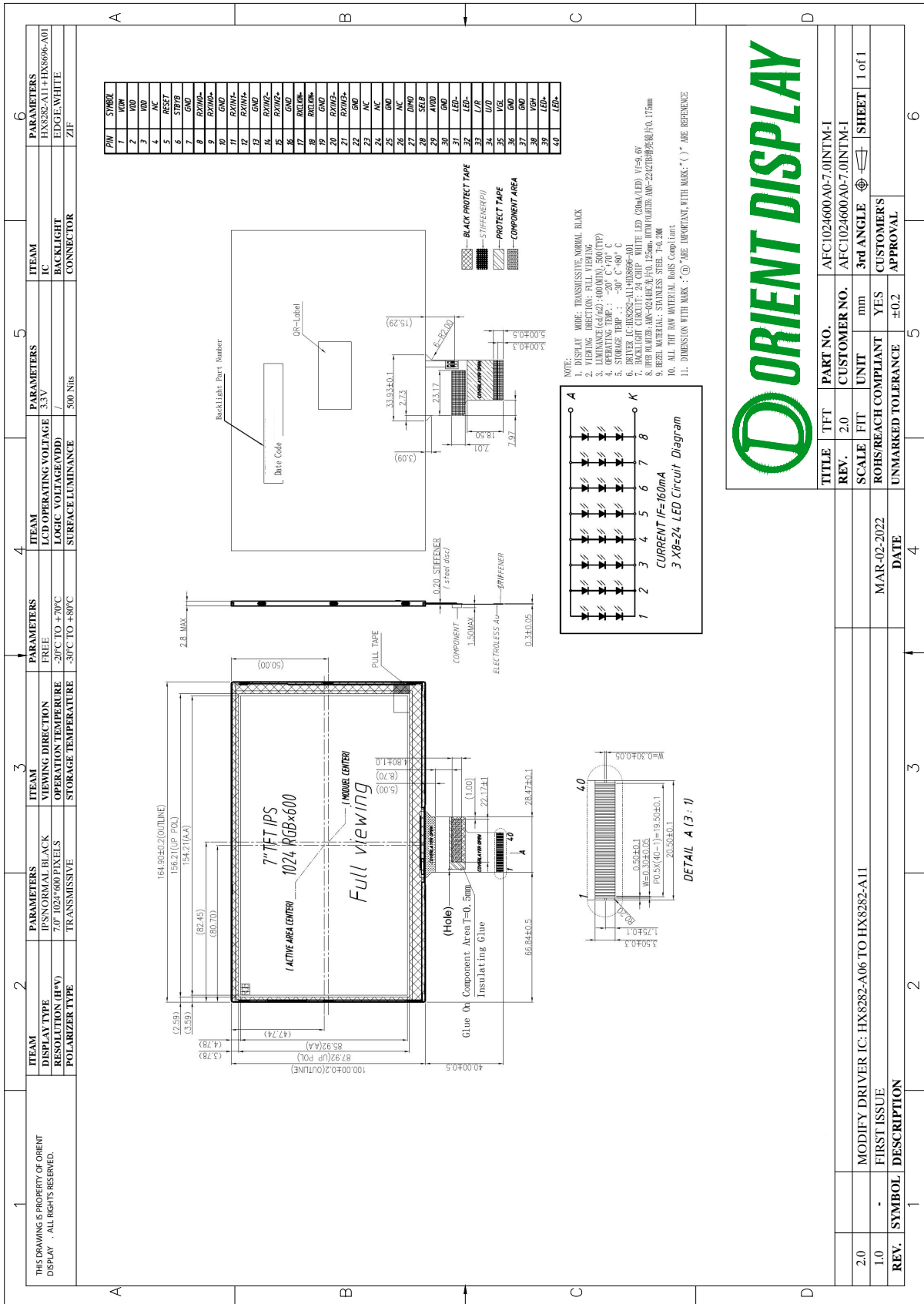

PIN	SYMBOL
1	VDD
2	VDD
3	VDD
4	NC
5	RESET
6	STRPB
7	GND
8	RZING+
9	RZING-
10	GND
11	RZING+
12	RZING-
13	GND
14	RZING+
15	RZING-
16	GND
17	RZING+
18	RZING-
19	GND
20	RZING+
21	RZING-
22	GND
23	NC
24	NC
25	GND
26	NC
27	DMO
28	SELB
29	VDD
30	GND
31	LED-
32	LED-
33	LED-
34	LED-
35	VGL
36	GND
37	VGH
38	GND
39	LED+
40	LED+

- NOTE:
1. DISPLAY MODE: TRANSMISSIVE, NORMAL BLACK
 2. VIEWING DIRECTIONS: ALL VIEWING
 3. AMBIENT LIGHT: 1000 LUX (MIN)
 4. OPERATING TEMP.: -20°C~70°C
 5. STORAGE TEMP.: -30°C~80°C
 6. DRIVER IC: HX8282-A11+HX8696-A01
 7. BACKLIGHT CIRCUIT: ZIF CHIP
 8. DISPLAY SIZE: 7.0" (178.0mm) (Diagonal)
 9. BEZEL MATERIAL: STAINLESS STEEL 1.4mm
 10. ALL THE RAW MATERIAL REQS. Comp. list
 11. DIMENSION WITH MARK: *⊕ ARE IMPORTANT, WITH MARK: (*) ARE REFERENCE

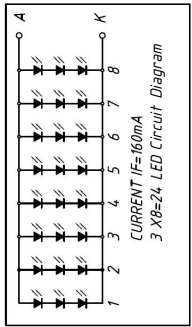

TITLE	TFT	PART NO.	AFC1024600A0-7.0INTM-1
REV.	2.0	CUSTOMER NO.	AFC1024600A0-7.0INTM-1
SCALE	FIT	UNIT	mm
ROHS/REACH COMPLIANT	YES	CUSTOMER'S APPROVAL	SHEET 1 of 1
DATE	MAR-02-2022	UNMARKED TOLERANCE	±0.2

REV.	MODIFY DRIVER IC: HX8282-A06 TO HX8282-A11	DATE	4
1.0	FIRST ISSUE		
REV. SYMBOL	DESCRIPTION		

11. Timing Characteristics

Please references HX8282-A11+HX8696-A01 data sheet.

12. Reliability

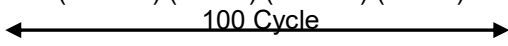
NO	Item	Test Condition
1	High Temperature Storage	Storage at $80 \pm 2^\circ\text{C}$ 240 hrs Surrounding temperature, then storage at normal condition 4hrs
2	Low Temperature Storage	Storage at $-30 \pm 2^\circ\text{C}$ 240 hrs Surrounding temperature, then storage at normal condition 4hrs
3	High Temperature Operation	Operation at $70 \pm 2^\circ\text{C}$ 240 hrs
4	Low Temperature Operation	Operation at $-20 \pm 2^\circ\text{C}$ 240 hrs
5	High Temperature /Humidity Operating	Operation at $40 \pm 2^\circ\text{C}$, 90%RH 240 hrs surrounding temperature, then storage at normal condition 4hrs.
6	Thermal shock (non-operation)	$-20^\circ\text{C} \rightarrow 25^\circ\text{C} \rightarrow 70^\circ\text{C} \rightarrow 25^\circ\text{C}$ (30mins) (5mins) (30mins) (5mins) 
7	Mechanical Test	Freq.: 10-55Hz Max. Acceleration: 5G X.Y.X. each direction For 10 mines.
		Drop them through 50cm height to strike horizontal plane
8	ESD Test	Air Discharge: Apply +/-8KV with 5 times Discharge for each polarity +/-
		Contact Discharge: Apply +/-6KV with 5 times Discharge for each polarity +/-
1. Temperature ambience: $15^\circ\text{C} \sim 35^\circ\text{C}$ 2. Humidity relative: 30%~60% 3. Energy Storage Capacitance(Cs+Cd): 150pF+/-10% 4. Discharge Resistance(Rd): 330Ω +/-10% 5. Discharge, mode of operation: Single Discharge (time between successive discharges at least 1 sec) (Tolerance if the output voltage indication: +/-5%)		

Note 1. For humidity test, DI water should be used

Inspection Standard: Inspect after 1-2hrs storage at room temperature, the sample shall be free from the following defects:

Air bubble in the LCD

Seal Leakage

Non-display

Missing Segment

Glass Crack

IDD is greater than twice initial value

Others as per QA Inspection Criteria

Note 2. No defect is allowed after testing.

- Note 3. ESD should be applied to LCD glass panel, not other areas (such as on IC and so on)
IDD should be within twice initial value.
In case of malfunction defect caused by ESD damage, if it would be recovered to normal state after resetting, it would be judged as a good part.
- Note 4. Only upon request.

13. Specification of Quality Assurance

13.1 Purpose

This standard for Quality Assurance assures the quality of LCD module products supplied to customer by ODNA.

13.2 Standard for Quality Test

ODNA performs the following tests to ensure the quality of product before shipment.

Sampling Plan:

GB/T2828.1-2003. Single sampling, Normal Inspection Level II.

Single sampling, normal inspection

Sampling Level:

Minor Defect: AQL 0.65%

Major Defect: AQL 0.15%.

Reliability Test:

Detailed requirement refer to Reliability Test Specification.

Nonconforming Analysis & Disposition

Nonconforming analysis

Customer should provide overall information of non-conforming sample for their complaints.

After receipt of detailed information from customer, the analysis of nonconforming parts usually should be finished in one week.

If ODNA can not finish the analysis on time, customer will be notified with the progress status.

Disposition of nonconforming:

Non-conforming product over ppm level will be replaced.

The cause of non-conformance will be analyzed. Corrective action will be discussed and implemented.

Agreement Items

ODNA and customer shall negotiate if the following situation occurs

There is any discrepancy in standard of quality assurance. Additional requirement to be added in product specification.

Any other special problem.

13.3 Standard of the Product Visual Inspection

Appearance inspection

The normal inspection must be under illumination no less than 800lux, and the distance of view must be between 30cm and 45cm;

When inspect the model of transmissive product, back light must be lighted.

The visual viewing angle should be 45° from the vertical line without reflection shine or follows customer's viewing angle specifications.

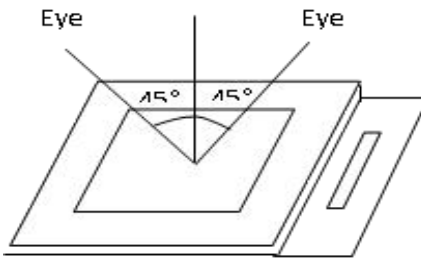

Definition of area(refer to product drawing)

A: Display area B: Viewing area C: Out of Viewing area

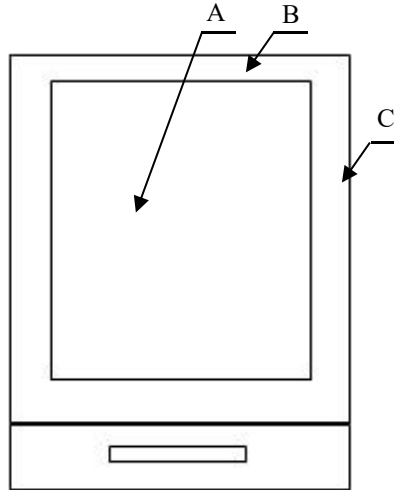

Basic principle:

According to IPC standards if standard is not described in specification.

A set of sample to indicate the limit of acceptable quality level must be discussed by both ODNA and customer when there is any dispute happened.

New item must be added on time when it is necessary.

13.4 Inspection Specification

No.	Item	Criteria (Unit: mm)		
Functional				
01	LC leakage	LC leakage	Reject	Maj
02	Non-display	Non-display	Reject	Maj
03	Missing segment/ Missing character, dot or icon.	 OK NG	Reject	Maj

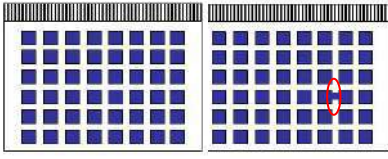
04	Exceeded dot/line/segment /Distortion	 OK NG	Reject	Maj
05	Dim Display	part of figures display dim than normal obviously	As the samples confirmed each other	Min
06	Wrong view angle	View angle is different from spec.	Reject	Maj
07	Not light	1.Backlight not work 2. Some LED not light	Reject	Maj
08	Backlight Luminance \ uniformity	According to the product specification or limited samples	Reject	Min
09	Backlight Color	According to the product specification or limited samples	Reject	Min
11	Connection failure	FPC gold finger damage	Reject	Maj

Cosmetic

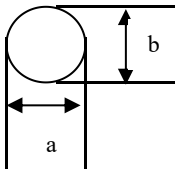
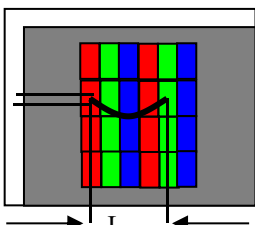
01	Black and white spot, Red, blue and green spot Dent Foreign material (Round type)	 $\phi = (a + b) / 2$ Distance between 2 defects should more than 10 mm apart.	<table border="1"> <thead> <tr> <th rowspan="2">Size (mm)</th> <th colspan="3">Area</th> </tr> <tr> <th colspan="3">Acc. Qty</th> </tr> <tr> <th></th> <th>A</th> <th>B</th> <th>C</th> </tr> </thead> <tbody> <tr> <td>$\phi \leq 0.15$</td> <td colspan="2">Ignore</td> <td>NC</td> </tr> <tr> <td>$0.15 < \phi \leq 0.3$</td> <td colspan="2">2</td> <td>NC</td> </tr> <tr> <td>$0.30 < \phi \leq 0.5$</td> <td colspan="2">1</td> <td>NC</td> </tr> <tr> <td>$\phi > 0.50$</td> <td colspan="2">0</td> <td>NC</td> </tr> <tr> <td>Total</td> <td colspan="2">3</td> <td>NC</td> </tr> </tbody> </table>	Size (mm)	Area			Acc. Qty				A	B	C	$\phi \leq 0.15$	Ignore		NC	$0.15 < \phi \leq 0.3$	2		NC	$0.30 < \phi \leq 0.5$	1		NC	$\phi > 0.50$	0		NC	Total	3		NC	Min	
Size (mm)	Area																																			
	Acc. Qty																																			
	A	B	C																																	
$\phi \leq 0.15$	Ignore		NC																																	
$0.15 < \phi \leq 0.3$	2		NC																																	
$0.30 < \phi \leq 0.5$	1		NC																																	
$\phi > 0.50$	0		NC																																	
Total	3		NC																																	
02	Black and White line Scratch Foreign material (Line type) (Min)	 <table border="1"> <thead> <tr> <th rowspan="2">Length (mm)</th> <th rowspan="2">Width (mm)</th> <th colspan="3">Acc. Qty</th> </tr> <tr> <th>A</th> <th>B</th> <th>C</th> </tr> </thead> <tbody> <tr> <td>/</td> <td>$W \leq 0.03$</td> <td colspan="2">Ignore</td> <td>NC</td> </tr> <tr> <td>$L \leq 5$</td> <td>$0.03 < W \leq 0.05$</td> <td colspan="2">2</td> <td>NC</td> </tr> <tr> <td>$L \leq 3$</td> <td>$0.05 < W \leq 0.1$</td> <td colspan="2">1</td> <td>NC</td> </tr> <tr> <td></td> <td>$W > 0.10$</td> <td colspan="2">0</td> <td>NC</td> </tr> <tr> <td colspan="2">Total</td> <td colspan="2">3</td> <td>NC</td> </tr> </tbody> </table> Distance between 2 defects should more than 10mm apart.	Length (mm)	Width (mm)	Acc. Qty			A	B	C	/	$W \leq 0.03$	Ignore		NC	$L \leq 5$	$0.03 < W \leq 0.05$	2		NC	$L \leq 3$	$0.05 < W \leq 0.1$	1		NC		$W > 0.10$	0		NC	Total		3		NC	Min
Length (mm)	Width (mm)	Acc. Qty																																		
		A	B	C																																
/	$W \leq 0.03$	Ignore		NC																																
$L \leq 5$	$0.03 < W \leq 0.05$	2		NC																																
$L \leq 3$	$0.05 < W \leq 0.1$	1		NC																																
	$W > 0.10$	0		NC																																
Total		3		NC																																

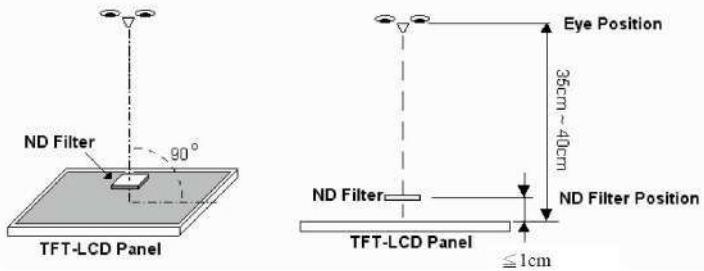
03	Polarizer concave and convex/bubbles	Diameter: Φ (mm)	Accept Qty			Min	
			A	B	C		
		$\Phi < 0.2\text{mm}$	Ignore	ignore	Ignore		
		$0.2\text{mm} < \Phi \leq 0.5\text{mm}$	3				
		$0.5\text{mm} < \Phi \leq 0.7\text{mm}$	2				
		$\Phi > 0.7\text{mm}$	Unacceptable				
Distance between 2 defects should more than 10mm apart.							
04	Bright/Dark dots, lines, Pixel defects	*A dot is defined as a single sub-pixel (either red, green, or blue) within a pixel. Definition of Bright dots: Dots that can be seen through 6% ND filter.	Allow			Min	
		Bright dots* (Min)	0				
		Adjacent bright dots	0				
		Dark dots*(Min)	2				
		Adjacent dark dots	0				
		Mura(50% GERY)	Judge by 6% ND filter, check with 30cm distance, if still can see, NG				
		Dark or Bright Lines	0				
		Blank pixel/ Missing pixel	Not allow				
		Remark: One pixel consists of 3 sub-pixels, including R, G and B dot(Sub-pixel=Dot)					
		Note 1 Bright dot is defined through 6% transmission ND filter as following:					
							
Defects on the black Matrix, out of viewing area, aren't considered as a defect counted.							

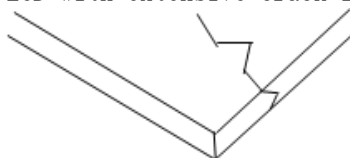
			<table border="1"> <tr> <td>Y: Width</td> <td>X: Length</td> </tr> <tr> <td>$Y \leq 1/4L$</td> <td>$X \leq A$</td> </tr> </table>	Y: Width	X: Length	$Y \leq 1/4L$	$X \leq A$	
Y: Width	X: Length							
$Y \leq 1/4L$	$X \leq A$							
		c) LCD with extensive crack line is unacceptable.						
06	Discolor/rainbow	Discolor between the LCDs or in the same LCD	Refer to the limit samples signed by customers or ODNA	Min				
07	FPC/FFC /TAB/HSC	Connect surface oxidation	Not allow	Maj				
		Etching/damage /distortion	Not exceed 1/3 width of wire	Min				
		Connect surface contamination /foreign material	Width & length of electric foreign material could not exceed the width of 2 pins	Min				
		Connect surface scratch	The scratch depth not exceed 1/2 thickness of gold layer.	Min				
		Copper/protective film/base board film separate	Not allow	Maj				
		Others: FPC follow IPC-6013A standard.						
08	Soldering	Cold soldering, short soldering	Reject	Min				
		Not enough solder paste	Solder paste area < 75% solder pad area Solder paste area < 75% component solder point Solder paste height < 1/2 component height	Min				

		FPC Pin deviation	Deviation area > 1/3 Solder pad	Min
		Others: Follow IPC-A-610E standard		
09	COG silicon coating	a) Not exceed the surface of top polarizer, LCD left/right edges. Cover fully ITO, IC and the juncture of HSC/FPC and LCD. b) No visible non-metal foreign material and metal material in coating c) Entrapped air bubble isn' t permissible to exist on the juncture of coating glue and pins of LCD. d) Bubbles or pinhole of silicon coating should $\Phi \leq 2\text{mm}$ e) The silicon should cover all around the IC and not gap in between silicon and side of IC, lack of coating on top of IC can be accepted		Min
10	Backlight	1.Spots or scratches that appear when light must be judged using LCD glass spot, line and contamination standards. 2.Brightness and Chromaticity can' t be out of specification.		Min

13.5 RoHS Compliance

The product should RoHS Compliance.

14. Package Specification

TBD

15. Precaution for Using LCD Module

15.1 Handing Precaution

- 15.1.1 The display panel is made of glass and polarizer. As glass is fragile. It tends to become or chipped during handing especially on the edges. Please avoid dropping or jarring. Do not subject it to a mechanical shock by dropping it or impact.
- 15.1.2 If the display panel is damaged and the liquid crystal substance leaks out, be sure not to get any in your mouth. If the substance contacts your skin or clothes, wash it off using soap and water.
- 15.1.3 Do not apply excessive force to the display surface or the adjoining areas since this may cause the color tone to vary. Do not touch the display with bare hands, This will stain the display area and degraded insulation between terminals(some cosmetics are determined to the polarizer)
- 15.1.4 The polarizer covering the display surface of the LCD module is soft and easily scratched. Handle this polarizer carefully. Do not touch, push or rub the exposed polarizer with anything harder than an HB pencil lead (glass, tweezers, etc.).Do not put or attach anything on the display area to avoid leaving marks on it. Condensation on the surface and

contact with terminals due to cold will damage, stain or dirty the polarizer. After products are tested at low temperature they must be warmed up in a container before coming in to contact with room temperature air.

- 15.1.5 If the display surface becomes contaminated, breathe on the surface and gently wipe it with a soft dry cloth. If it is heavily contaminated, moisten cloth with one of the following solvents, -Isotropy alcohol or Ethyl alcohol; do not scrub hard to avoid damaging the display surface.
- 15.1.6 Solvents other than those above-mentioned madly damage the polarizer. Especially, do not use the following: water, Ketone, Aromatic solvents. Wipe off saliva or water drops immediately, contact with water over a long period of time may cause deformation or color fading. Avoid contact with oil and fats.
- 15.1.7 Exercise care to minimize corrosion of the electrode. Corrosion of the electrodes is accelerated by water droplets, moisture condensation or current flow in a high-humidity environment.
- 15.1.8 Install the LCD module by using the mounting holes. When mounting the LCD module make sure it is free of twisting, warping and distortion. In particular, do not forcibly pull or bend the I/O cable or the backlight cable.
- 15.1.9 Do not attempt to disassemble or process the LCD module.
- 15.1.10 NC terminal should be open. Do not connect anything.
- 15.1.11 If the logic circuit power is off, do not apply the input signals.
- 15.1.12 Electro-Static Discharge control, since this module uses a CMOS LSI, the same careful attention should be paid to electrostatic discharge as for an ordinary CMOS IC. To prevent destruction of the elements by static electricity, be careful to maintain an optimum work environment.
- 15.1.13 Since LCM has been assembled and adjusted with a high degree of precision, avoid applying excessive shocks to the module or making any alterations or modifications to it.

15.2 Storage Precaution

- 15.2.1 Store them in a sealed polyethylene bag. If properly sealed, there is no need for the desiccant.
- 15.2.2 Store them in a dark place. Do not expose to sunlight or fluorescent light, keep the temperature between 0°C and 35°C, and keep the relative humidity between 40% RH and 60% RH.
- 15.2.3 The polarizer surface should not come in contact with any other objects (we advise you to store them in anti-static electricity container in which they were shipped).
- 15.2.4 During shipment, please handle with care. The packaging bag can not be broken, step on trap. Packaging Carton layer height can not be over two meters.
- 15.2.5 The transportation process should pay attention to the waterproof and moisture-proof measures. Product can not be watering. Ethylene sealed bags can not be unsealed.
- 15.2.6 Liquid crystals solidify under low temperature (below the storage temperature range) leading to defective orientation or the generation of air bubbles (black or white). Air bubbles may also be generated if the module is subject to a low temperature.
- 15.2.7 If the LCD modules have been operating for a long time showing the same display patterns, the display patterns may remain on screen as ghost images and a slight contrast irregularity may also appear. A normal operating status can be regained by suspending use for some time. It should be noted that this phenomenon does not adversely affect performance reliability.
- 15.2.8 To minimize the performance degradation of the LCD modules resulting from destruction caused by static electricity etc.,

15.3 Using LCD Modules

- 15.3.1 The hole in the printed circuit board is used to fix LCM. Attend to the following items when installing the LCM. Cover the surface with a transparent protective plate to protect

the polarizer and LC cell.

- 15.3.2 When assembling the LCM into other equipment, the spacer to the bit between the LCM and the fitting plate should have enough height to avoid causing stress to the module surface, refer to the individual specifications for measurements. The measurement tolerance should be +/-0.1mm.
- 15.3.3 Precaution for assemble the module with BTB connector; Please note the position of the male and female connector position.
- 15.3.4 Precaution for soldering the LCM, Manual soldering temperature 300+/-20°C, time is 3~5S.
- 15.3.5 If soldering flux is used, be sure to remove any remaining flux after finishing to soldering operation (This does not apply in the case of a non-halogen type of flux). It is recommended that you protect the LCD surface with a cover during soldering to prevent any damage due to flux spatters.
- 15.3.6 When soldering the electroluminescent panel and PC board, the panel and board should not be detached more than three times. This maximum number is determined by the temperature and time conditions mentioned above, though there may be some variance depending on the temperature of the soldering iron.
- 15.3.7 When remove the electroluminescent panel from the PC board, be sure the solder has completely melted, the soldered pad on the PC board could be damaged.

15.4 Precautions for Operation

- 15.4.1 Viewing angle varies with the change of liquid crystal driving voltage (VLCD). Adjust VLCD to show the best contrast.
- 15.4.2 It is an indispensable condition to drive LCD within the specified voltage limit since the higher voltage then the limit cause the shorter LCD life. An electrochemical reaction due to direct current causes LCD undesirable deterioration, so that the use of direct current drive should be avoid.
- 15.4.3 Response time will be extremely delayed at lower temperature than the operating temperature range and on the other hand at higher temperature LCD show dark color in them. However those phenomena do not mean malfunction or out of order with LCD which will come back in the specified operating temperature.
- 15.4.4 If the display area is pushed hard during operation, the display will become abnormal. However, it will return to normal if it is turned off and back on.
- 15.4.5 Slight dew depositing on terminals is a cause for electro-chemical reaction resulting in terminal open circuit. Usage under the maximum operating temperature, 50%RH or less is required.
- 15.4.6 Input logic voltage before apply analog high voltage such as LCD driving voltage when power on. Remove analog high voltage before logic voltage when power off the module. Input each signal after the positive & negative voltage becomes stable.
- 15.4.7 Please keep the temperature within the specified range for use and storage. Polarization degradation, bubble generation or polarizer peel-off many occur with high temperature and high humidity.

15.5 Safety

- 15.5.1 It is recommended to crush damaged or unnecessary LCD into pieces and wash them off with solvents such as acetone and ethanol, which should later be burned.
- 15.5.2 If any liquid leaks out of a damaged glass cell and comes in contact with the hands, wash off thoroughly with soap and water.

15.6 Limited Warranty

- 15.6.1 Unless otherwise agreed between ODNA display and customer, ODNA display will replace or repair any of its LCD and LCM which ODNA display found to be defective electrically and visually when inspected in accordance with ODNA display quality standards, for a period

of one year from date of shipment.

15.6.2 The warranty liability of ODNA display is limited to repair and/or replacement. ODNA display will not be responsible for any consequential loss.

15.6.3 If possible, we suggest you use up all modules in six months. If the module storage time over twelve months, we suggest that recheck it before the module be used.