



ORIENT DISPLAY

Your Total LCD Solution Provider

Specification for LCD Module

AFY1024600A0-7.0INTH

Revision I



A	Orient Display
FY	TFT Type
1024600	Resolution 1024 x 600
A0	Serial A0
7.0	7.0", Module Dimension 164.80 x 99.80 x 5.60 mm
I	IPS Display
N	Top: -20~+70°C; Tstr: -30~+80°C
T	Transmissive
H	High Brightness, 1000 cd/m2
/	No Touch Panel
/	Controller EK79001HN + EK73215BCGA Or Compatible
/	LVDS Interface



CONTENTS

1. GENERAL INFORMATION	4
2. ABSOLUTE MAXIMUM RATINGS.....	4
3. ELECTRICAL CHARACTERISTICS.....	5
4. BACKLIGHT CHARACTERISTICS	5
5. EXTERNAL DIMENSIONS.....	6
6. ELECTRO-OPTICAL CHARACTERISTICS	7
7. INTERFACE DESCRIPTION.....	9
8.AC CHARACTERISTICS	10
9. POWER SEQUENCE	15
10. RELIABILITY TEST CONDITIONS	16
11.INSPECTION CRITERION	17
12. HANDLING PRECAUTIONS.....	17
13. PRECAUTION FOR USE	18
14. PACKING SPECIFICATION	18
15. HSF COMPLIANCE	17

1. GENERAL INFORMATION

No.	Item	Contents	Unit
1	LCD size	7.0 inch (Diagonal)	/
2	Display mode	IPS/NormallyBlack/TRANSMISSIVE(ANTI-GLARE)	/
3	Viewing direction(eye)	Free	/
4	Gray scale inversion direction	-	/
5	Resolution(H*V)	1024*600 Pixels	/
6	Module size (L*W*H)	164.8*99.8*5.6	mm
7	Active area (L*W)	154.21*85.92	mm
8	Pixel pitch (L*W)	0.1506* 0.1432	mm
9	Interface type	LVDS Interface	/
10	Color Depth	16.7M	/
11	Module power consumption	4.905	W
12	Back light type	White LED	/
13	Driver IC	EK79001HN+EK73215BCGA or compatible	/
14	Weight	TBD	G

2. ABSOLUTE MAXIMUM RATINGS

Item	Symbol	Min.	Max.	Unit	Note
Power supply input voltage for TFT	VDD	-0.5	4.6	V	
Backlight current (normal temp.)	ILED	-	600	mA	
Operation temperature	Top	-20	70	°C	Note1
Storage temperature	Tst	-30	80	°C	Note1
Humidity	RH	20%	90%(Max60°)	RH	Note1

Note1 :

- 1).The relative humidity and temperature range are as below sketch,90%RH Max.
- 2).The maximum wet bulb temperature $\leq 40^{\circ}\text{C}$ and without dewing.

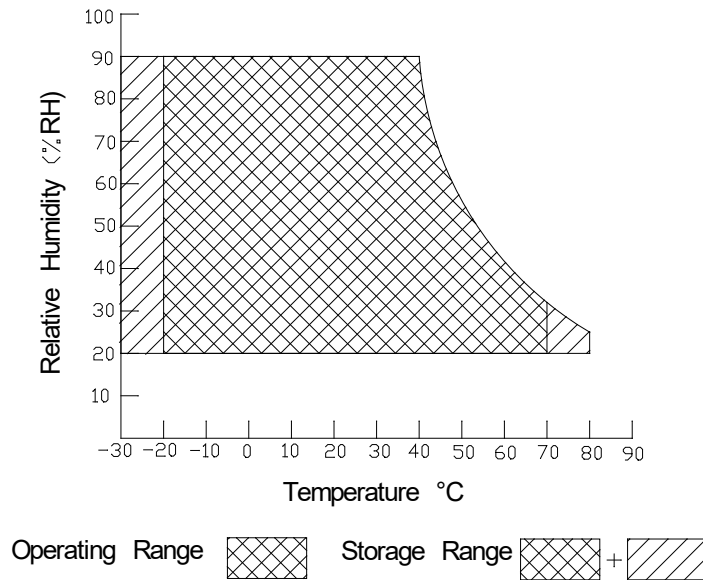

3. ELECTRICAL CHARACTERISTICS

DC CHARACTERISTICS(at Ta=25°C)

Item	Symbol	Min.	Typ.	Max.	Unit	Note
Power supply input voltage	VDD	2.7	3.3	3.6	V	
I/O logic voltage	VDDIO	N/A	N/A	N/A	V	
Input voltage 'H' level	VIH	0.7VDD	-	VDD	V	
Input voltage 'L' level	VIL	0	-	0.3VDD	V	
Power supply current	IVDD	-	90	-	mA	
TFT gate on voltage	VGH	-	-	-	V	
TFT gate off voltage	VGL	-	-	-	V	
Analog power supply voltage	AVDD	-	-	-	V	
Differential input common mode voltage	Vcom	-	-	-	V	Note1

Note1 : The value is just the reference value. The customer can optimize the setting value by the different D-IC
Vcom must be adjusted to optimize display quality, as Crosstalk and Contrast Ratio etc..

4. BACKLIGHT CHARACTERISTICS

(at Ta=25°C,RH=60%)

Item	Symbol	Min.	Typ.	Max.	Unit	Note
LED forward voltage	VF	8.7	9.6	10.5	V	
LED forward current	IF	-	480	-	mA	IF=60*8mA
LED power consumption	PLED	-	4.608	-	W	Note1
Number of LED	-		24		PCS	
Connection mode	-	3 in series *8 in parallel			/	
LED life-time	-	-	50000	-	Hrs	Note2

Note1 : Calculator value for reference : $IF \cdot VF = PLED$

Note2 : The LED life-time define as the estimated time to 50% degradation of initial brightness at Ta=25°C and IF =480mA. The LED lifetime could be decreased if operating IF is larger than 480mA.

5. EXTERNAL DIMENSIONS

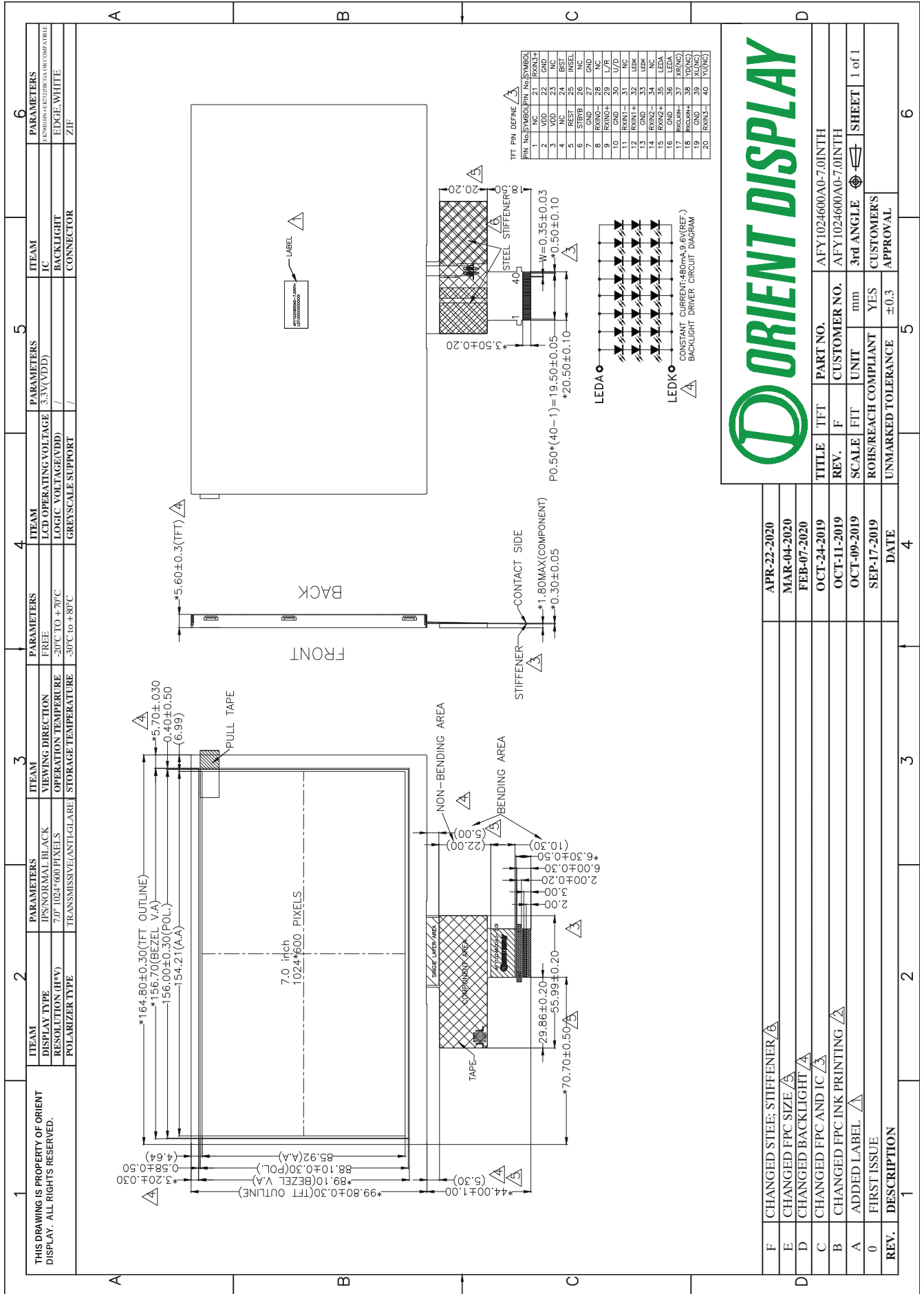

6. ELECTRO - OPTICAL CHARACTERISTICS

Item	Symbol	Condition	Min.	Typ.	Max.	Unit	Remark	Note
Response time	Tr+ Tf	-	-	25	50	ms	FIG.1	Note 1
Contrast ratio	Cr		500	650	-	-	FIG.2	Note 2
Surface luminance	Lv	$\theta=0^\circ$	800	1000	-	cd/m ²	FIG.2	Note 3
Luminance uniformity	Yu	$\theta=0^\circ$	75	80	-	%	FIG.2	Note 4
NTSC	-	$\theta=0^\circ$	-	50	-	%	FIG.2	Note 5
Viewing angle	θ	$\varnothing=90^\circ$	-	85	-	deg	FIG.3	Note 6
		$\varnothing=270^\circ$	-	85	-	deg	FIG.3	
		$\varnothing=0^\circ$	-	85	-	deg	FIG.3	
		$\varnothing=180^\circ$	-	85	-	deg	FIG.3	
CIE (x,y) chromaticity	Red x	$\theta=0^\circ$ $\varnothing=0^\circ$ $T_a=25^\circ\text{C}$	Typ -0.04	0.60	Typ +0.04	-	FIG.2 CIE1931	Note 5
	Red y			0.35		-		
	Green x			0.31		-		
	Green y			0.58		-		
	Blue x			0.15		-		
	Blue y			0.10		-		
	White x			0.29		-		
	White y			0.32		-		

Note1. Definition of response time

The response time is defined as the LCD optical switching time interval between “White” state and “Black”state. Rise time (T_{ON}) is the time between photo detector output intensity changed from 90% to 10%. And fall time (T_{OFF}) is the time between photo detector output intensity changed from 10% to 90%. For additional information see FIG1.

Note2. Definition of contrast ratio

Contrast ratio(Cr) is defined mathematically by the following formula. For more information see FIG.2.

$$\text{Contrast ratio} = \frac{\text{Luminance measured when LCD on the "White" state}}{\text{Luminance measured when LCD on the "Black" state}}$$

Measured at the center area of the LCD

Note3. Definition of surface luminance

Surface luminance is the luminance with all pixels displaying white. For more information see FIG.2.

$$L_v = \text{Average Surface Luminance with all white pixels}(P_1, P_2, P_3, \dots, P_n)$$

Note4. Definition of luminance uniformity

The luminance uniformity in surface luminance is determined by measuring luminance at each test position 1 through n, and then dividing the maximum luminance of n points luminance by minimum luminance of n points luminance. For more information see FIG.2.

$$Y_u = \frac{\text{Minimum surface luminance with all white pixels}(P_1, P_2, P_3, \dots, P_n)}{\text{Maximum surface luminance with all white pixels}(P_1, P_2, P_3, \dots, P_n)}$$

Note5. Definition of color chromaticity (CIE1931)

CIE (x,y) chromaticity, The x,y value is determined by screen active area center position P5. For more information see FIG.2.

Note6. Definition of viewing angle

Viewing angle is the angle at which the contrast ratio is greater than 10. angles are determined for the horizontal or x axis and the vertical or y axis with respect to the z axis which is normal to the LCD surface. For more information see FIG.3.

For viewing angle and response time testing, the testing data is base on Autronic-Melchers's ConoScope or DMS series Instruments or compatible. For contrast ratio, Surface Luminance, Luminance uniformity and CIE, the testing data is base on TOPCON's BM-5 or BM-7 photo detector or compatible.

FIG.1. The definition of response Time

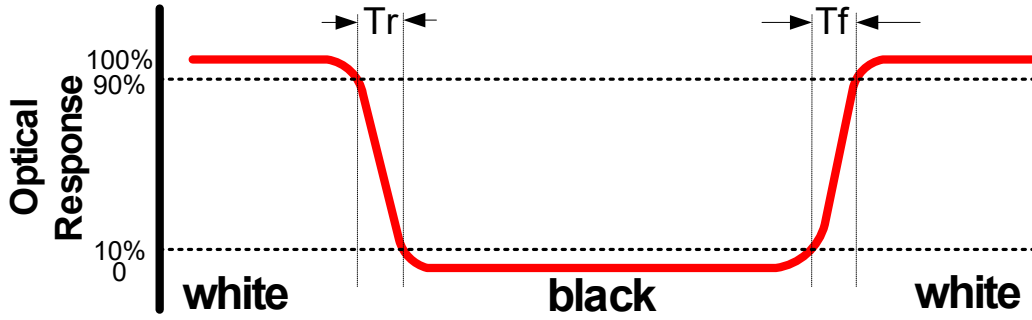

FIG.2. Measuring method for contrast ratio, surface luminance, luminance uniformity, CIE (x,y) chromaticity

H,V : Active area

Light spot size $\varnothing = 5 \text{ mm}$ (BM-5) or $\varnothing = 7.7 \text{ mm}$ (BM-7) 50cm distance or compatible distance from the LCM surface to detector lens.

Test spot position : see Figure a.

measurement instrument : TOPCON's luminance meter BM-5 or BM-7 or compatible ,see Figure b.

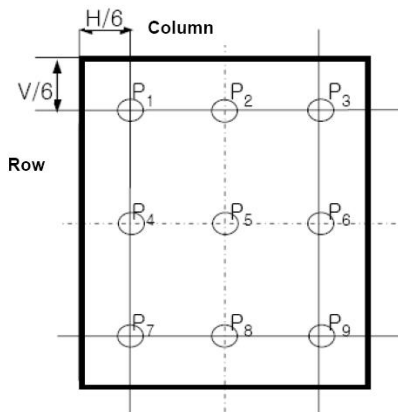

Figure a

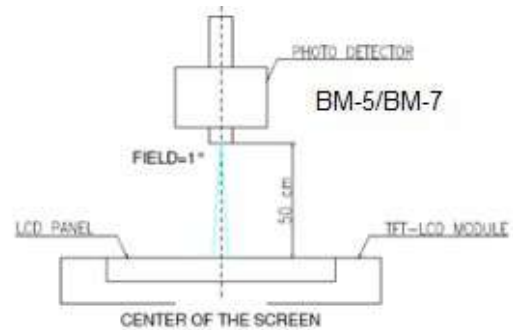
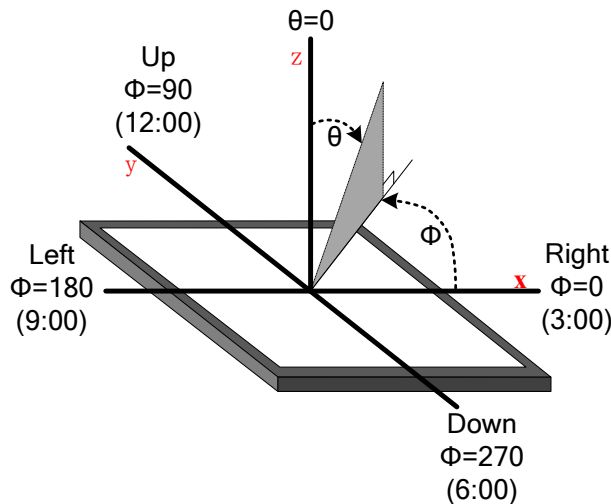

Figure b

FIG.3. The definition of viewing angle



7. INTERFACE DESCRIPTION

Module Interface description

Interface NO.	PIN NAME	I/O	DESCRIPTION
1	N/C	Float	No connection,Please float it
2-3	VDD	P	Power supply for digital
4	NC	Float	No connected.
5	REST	I	Global reset pin. Active Low. Normally pull high.
6	STBYB	I	Display on/off switch,"H" display off
7	GND	P	Ground
8	RXIN0-	I/O	LVDS data lane 0-
9	RXIN0+	I/O	LVDS data lane 0+
10	GND	P	Ground
11	RXIN1-	I/O	LVDS data lane 1-
12	RXIN1+	I/O	LVDS data lane 1+
13	GND	P	Ground
14	RXIN2-	I/O	LVDS data lane 2-
15	RXIN2+	I/O	LVDS data lane 2+
16	GND	P	Ground
17	RXCLKIN-	I/O	LVDS clk lane -
18	RXCLKIN+	I/O	LVDS clk lane +
19	GND	P	Ground
20	RXIN3-	I/O	LVDS data lane 3-
21	RXIN3+	I/O	LVDS data lane 3+
22	GND	P	Ground
23	NC	Float	No connection,Please float it
24	BIST	I	Normal Operation/BIST pattern select. Normally pull low BIST = H : BIST(DCLK input is not needed) BIST = L : Normal Operation
25	INSEL	I	In LVDS interface INSEL = L : 8 bit INSEL = H : 6 bit
26	NC	Float	No connection,Please float it
27	GND	P	Ground
28	NC	Float	No connection,Please float it
29	L/R	I	L/R="L" Scan direction from right to left; L/R="H" Scan direction from left to right;
30	U/D	I	U/D="L" Scan direction from down to up; U/D="H" Scan direction from up to down;
31	NC	Float	No connection,Please float it
32-33	LEDK	P	LED Cathode for BL
34	NC	Float	No connection,Please float it
35-36	LEDA	P	LED ANODE for BL
37	XR/NC	Float	No connection,Please float it
38	YD/NC	Float	No connection,Please float it
39	XL/NC	Float	No connection,Please float it
40	YU/NC	Float	No connection,Please float it

8.AC CHARACTERISTICS

LVDS mode

Parameter	Symbol	Condition	Min.	Typ.	Max.	Unit
Clock Frequency	RxFCLK		20	-	71	MHz
Input data skew margin	T _{RSKM}	V _{ID} =400mV R _{XVCM} =1.2V R _{XFCLK} =71MHz	500			ps
Clock High Time	T _{LVCH}			4/(7* RxFCLK)		ns
						ns
Clock Low Time	T _{LVCL}			3/(7* RxFCLK)		ns
PLL wake-up-time	T _{enPLL}				150	us

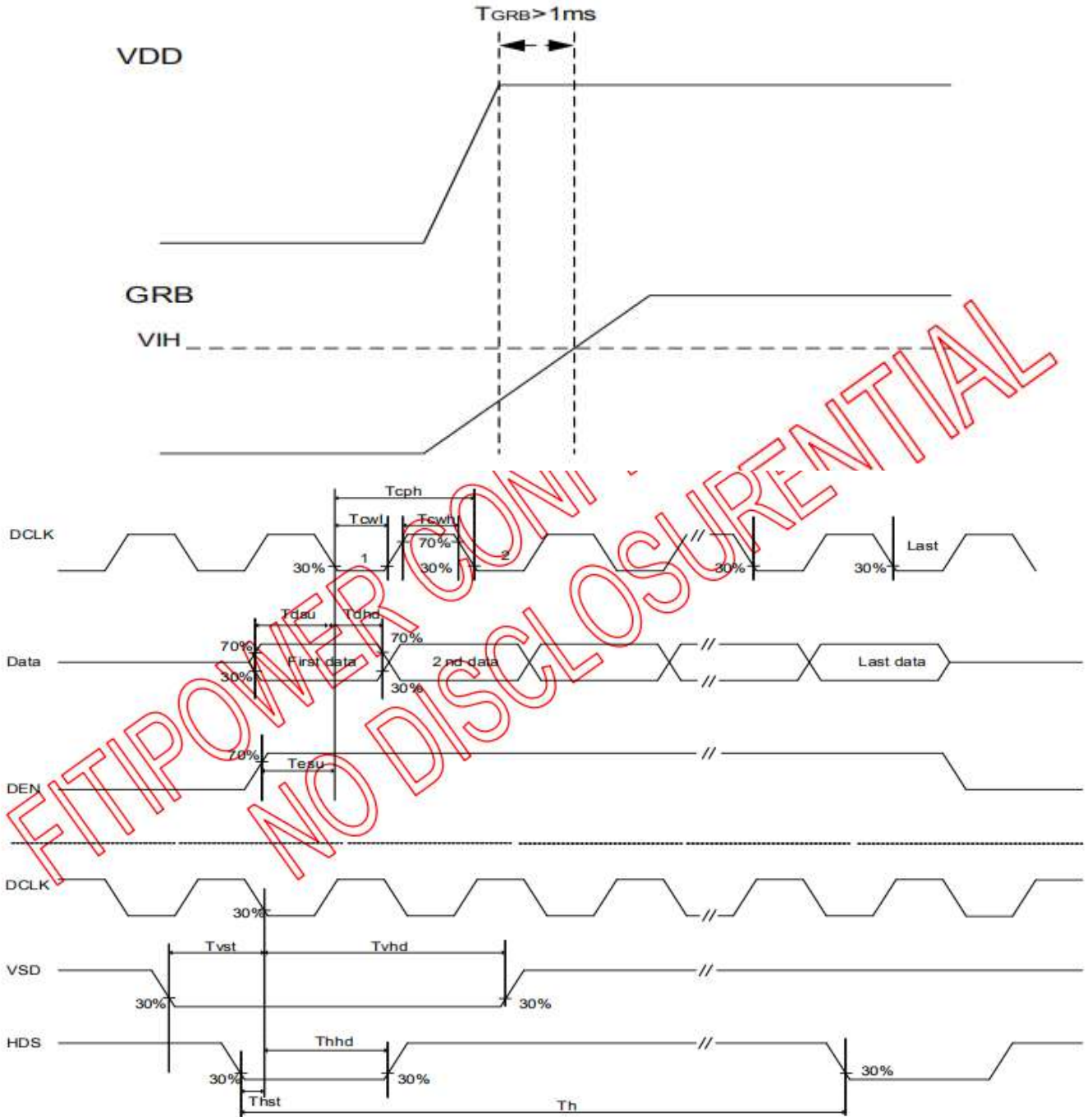

Parallel Input Clock and Data timing

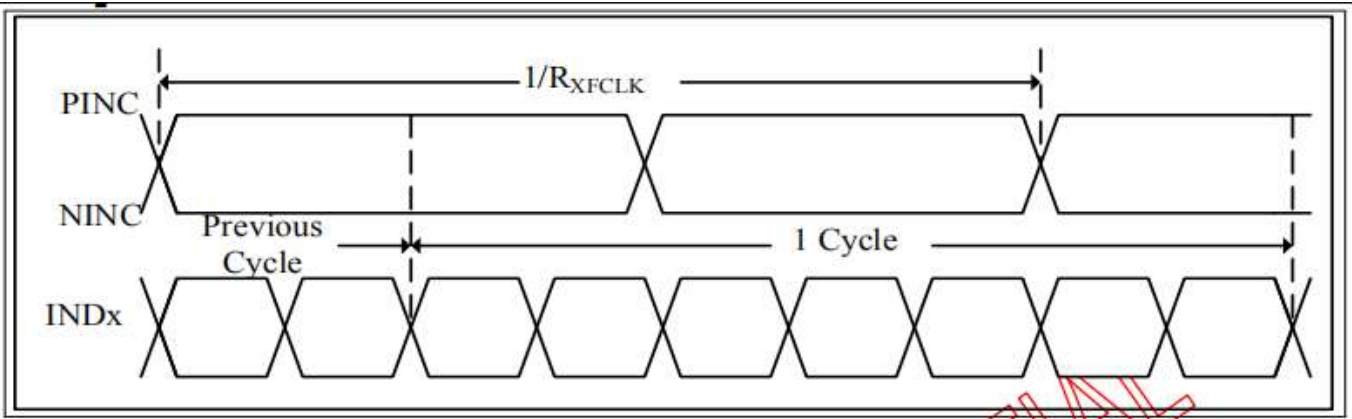

LVDS timing(1)

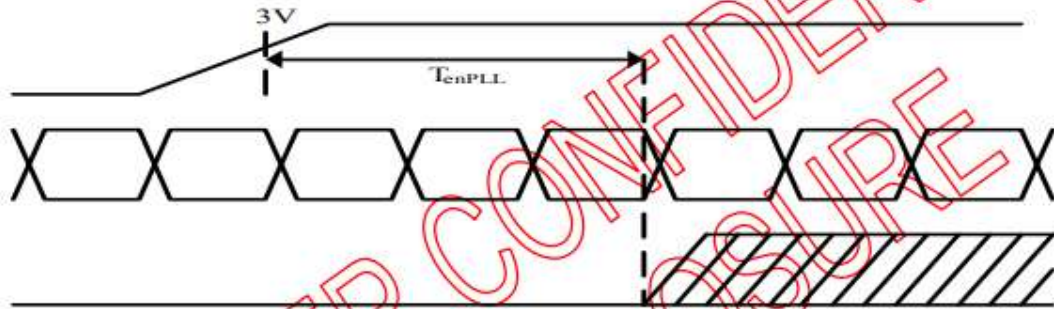

LVDS timing(2)

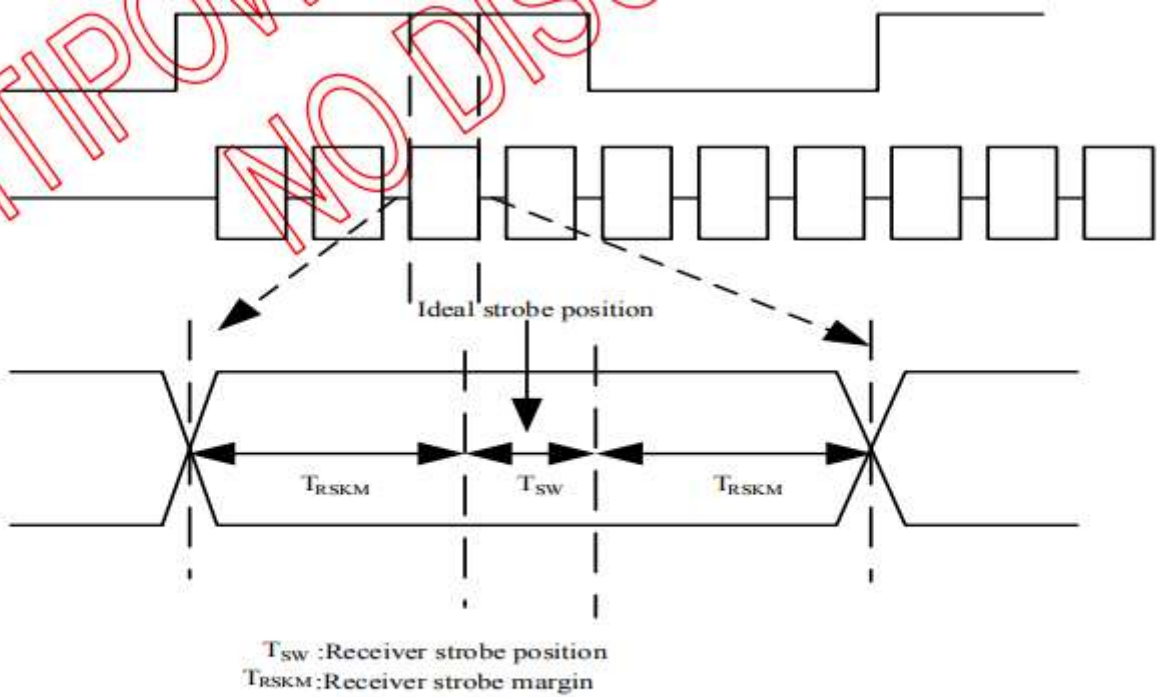

LVDS timing(3)

Output Timing Table

Parameter	Symbol	Min.	Typ.	Max.	Unit	Condition
DCLK frequency	Fclk	-	65	71	MHz	VDD =2.3~3.6V
DCLK cycle time	Tclk	14.1	15.4		ns	
DCLK pulse duty	Tcwh	40	50	60	%	Tclk
Time from HSD to Source Output	Thso	-	64	-	DCLK	
Time from HSD to LD	Thld	-	64	-	DCLK	
Time from HSD to STV	Thstv	-	2	-	DCLK	
Time from HSD to CKV	Thckv	-	20	-	DCLK	
Time from HSD to OEV	Thoev	-	4	-	DCLK	
LD pulse width	Twid	-	10	-	DCLK	
CKV pulse width	Twckv	-	66	-	DCLK	
OEV pulse width	Twoev	-	74	-	DCLK	

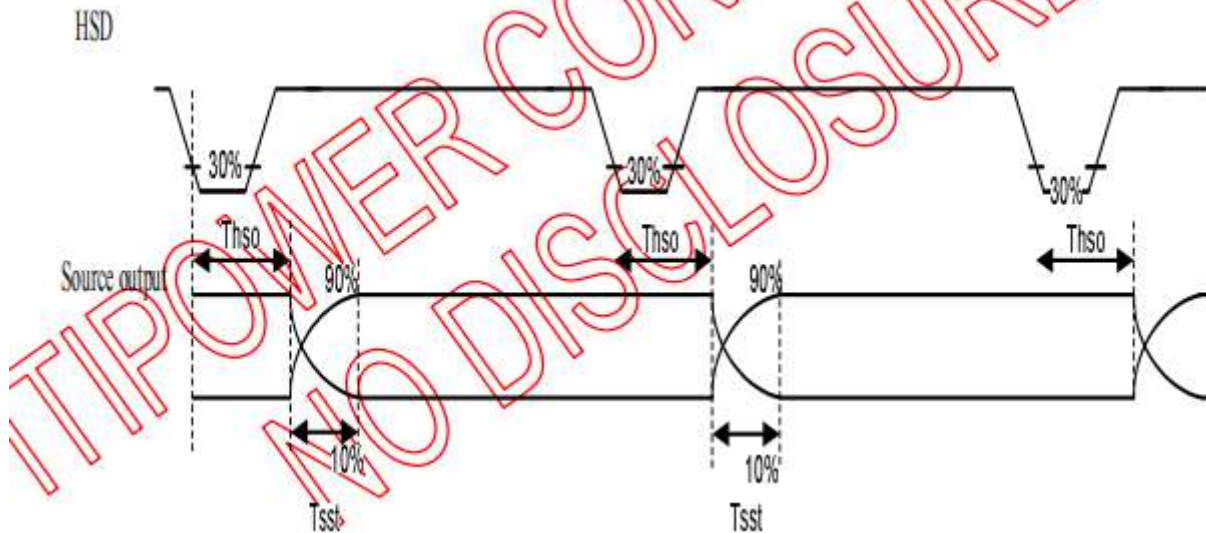

Measure point

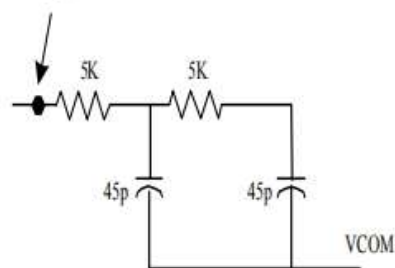

Source Output Timing

Vertical Timing Diagram HV mode

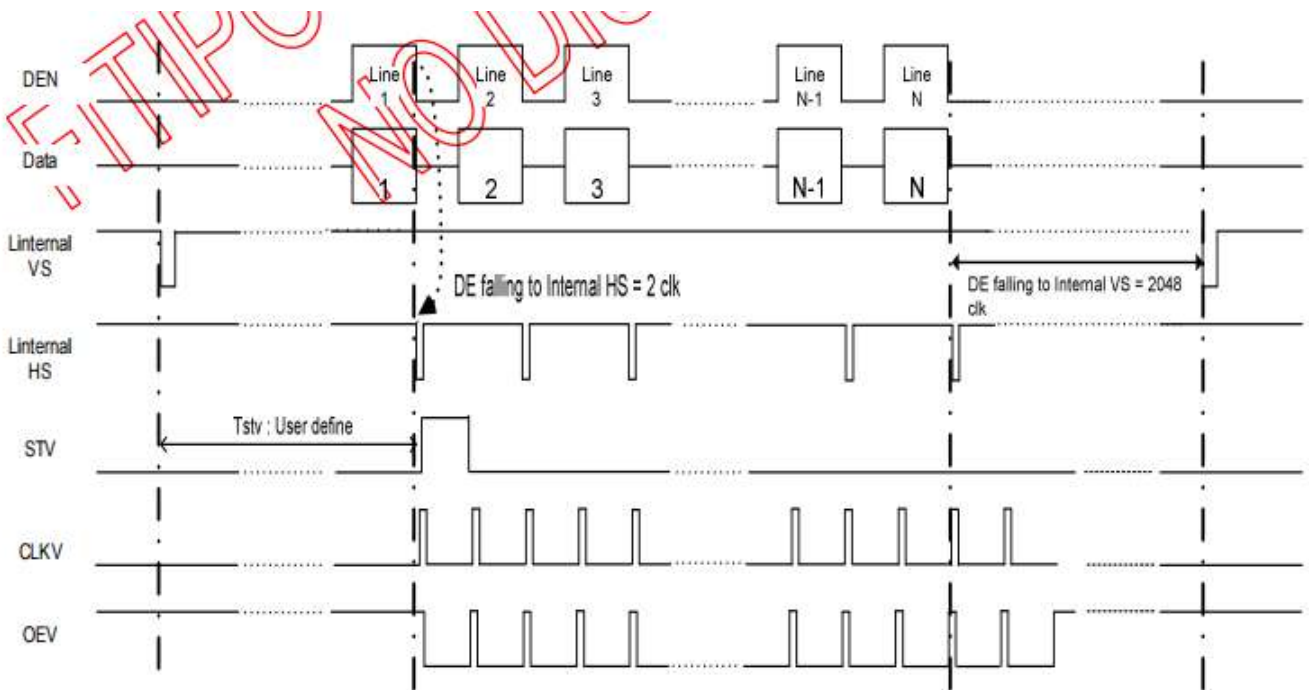
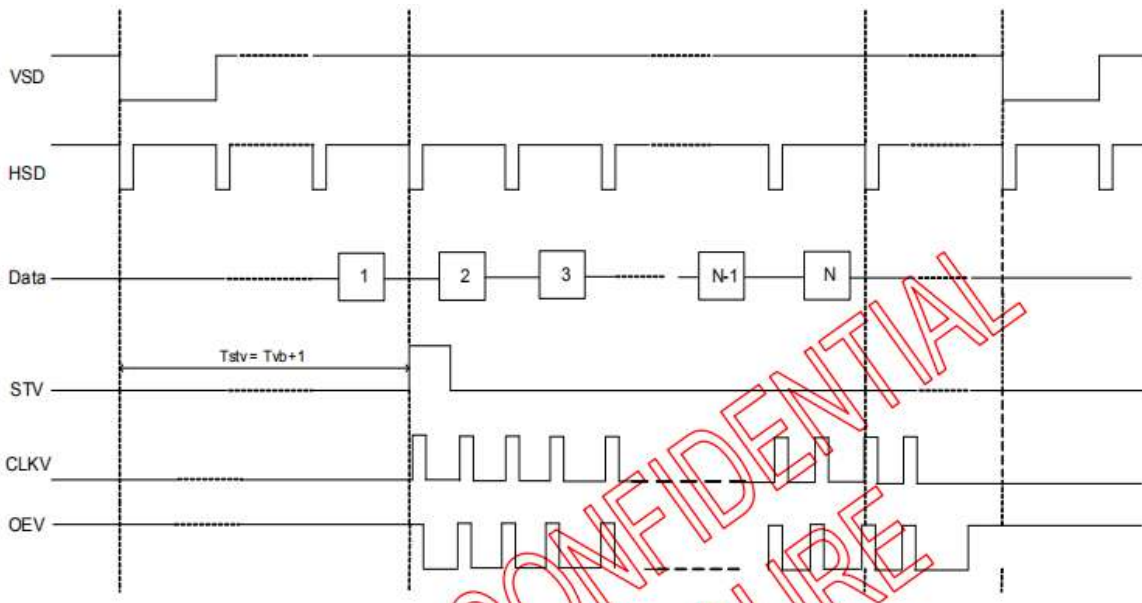

Vertical Timing Diagram DE mode

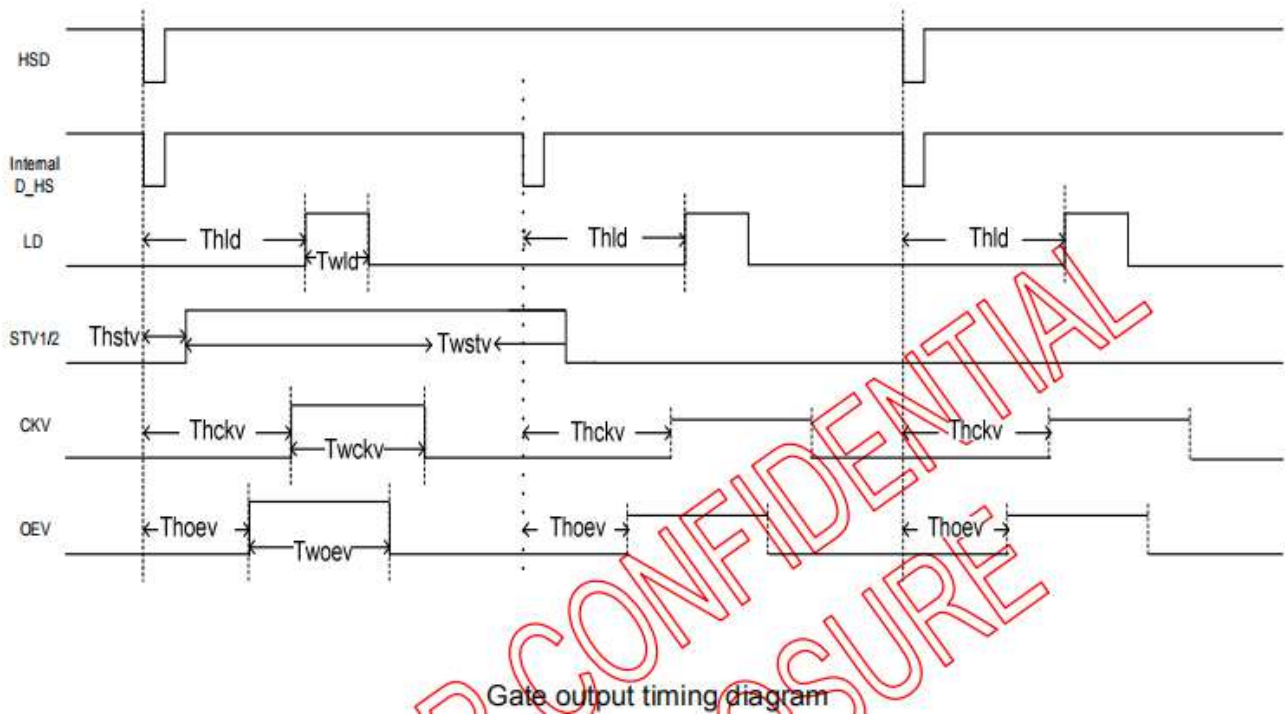

SDRRS(seamless display refresh rate switching)

When Showing the still picture.it is accept to refresh rate from 60Hz to low refresh rate (for example 40Hz).The purpose is mainly for power saving. INTEL defined a timing chart switch between different refresh rate.Following this timing chart,the switch between different refresh rates is seamless for end user.

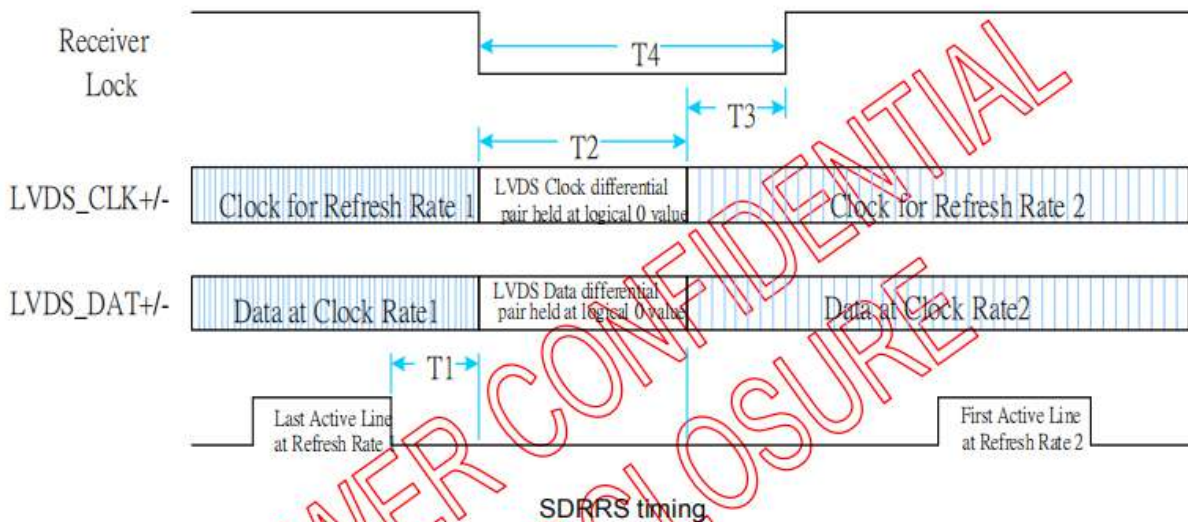

- T1-Min delay from start of vertical blank to start of timing change:2 lines(HSYNC periods)
- T2-Max delay for clock to transition to new frequency:100us
- T3-Max receiver lock delay from stable clock: Display specific
- T4-Max period during which panel maintains display(T2+T3): Display specific

9. POWER SEQUENCE

To prevent the device damage from latch up and Improve subjective display effect, the power ON/OFF sequence shown below must be followed.

In order to prevent IC from power on reset fail, the rising time (TPOR) of the digital power supply VDD should be maintained within the given specifications. Refer to "AC Characteristics" for more detail on timing.

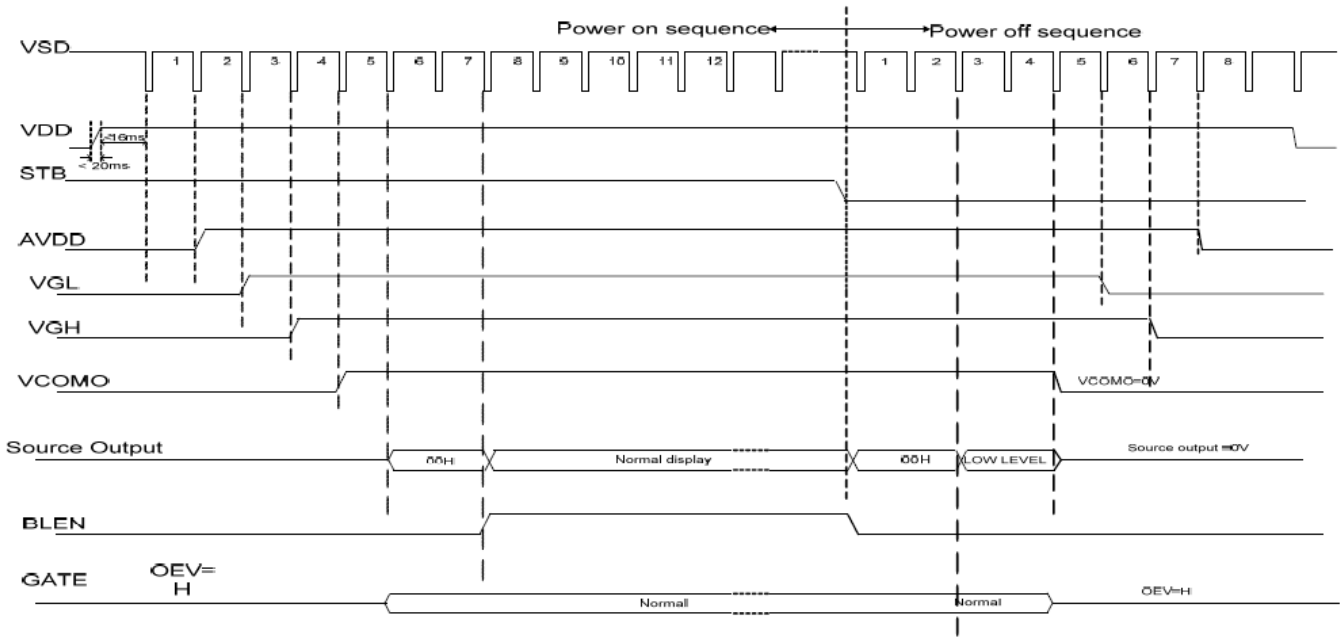

Power On/Off timing chart

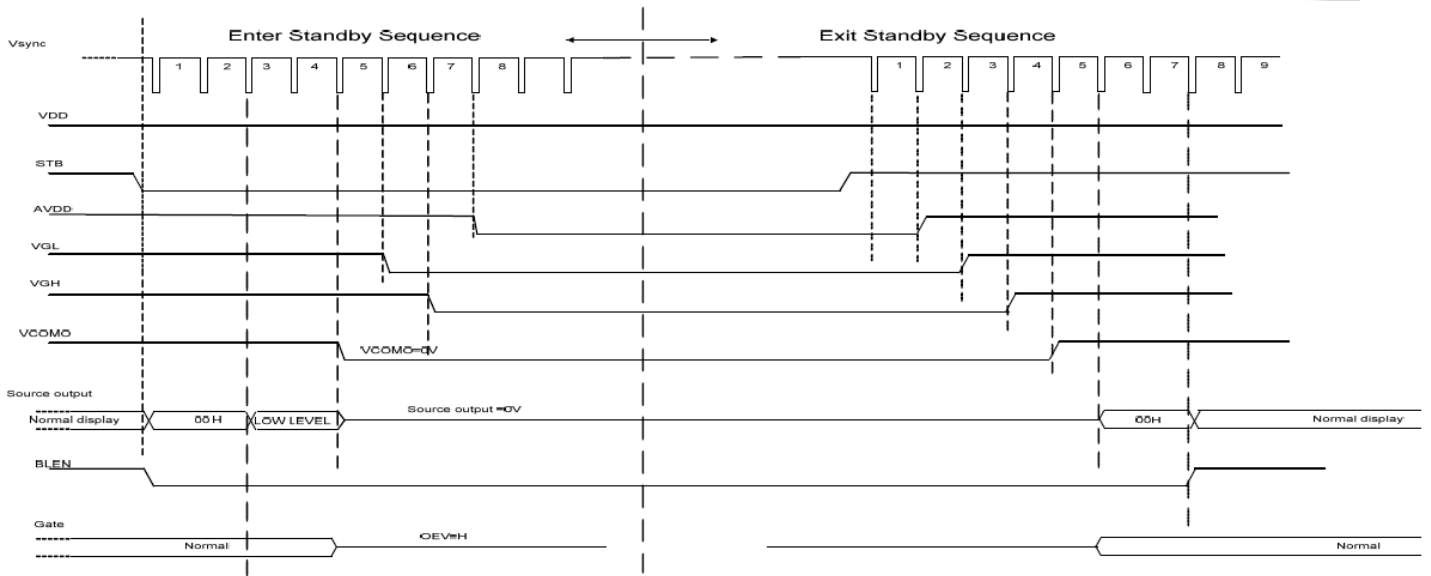

Enter and Exit Standby Mode timing chart

10. RELIABILITY TEST CONDITIONS

No.	Test Item	Test Condition	Inspection after test
1	High Temperature Storage	+80C/240 hours	Inspection after 2~4hours storage at room temperature, the sample shall be free from defects: 1.Current changing value before test and after test is 50% larger; 2. function defect:Non-display ,abn ormal-display,missing lines,Short lines, ITO corossion; 3.visual defect:Air bubble in the LCD,Sealleak,Glass crack。
2	Low Temperature Storage	-30°C/240 hours	
3	High Temperature Operating	+70°C/120 hours	
4	Low Temperature Operating	-20°C/120 hours	
5	Temperature Cycle	-30°C ~ 25°C ~ +80°C/10cycles (30min.) (10min.) (30min.)	
6	Damp Proof Test	50°C*90% RH/120 hours	
7	Vibration Test	Frequency: 10Hz~55Hz~10Hz Amplitude: 1.5mm, X, Y, Z direction for total 3hours (Packing condition)	
8	Dropping test	Drop to the ground from 1m height, one time, every side of carton. (Packing condition)	
9	ESD test	Voltage:±8KV R: 330Ω C: 150pF Air discharge, 10times	

Remark:

- 1.The test samples should be applied to only one test item.
- 2.Sample size for each test item is 3~5pcs.
- 3.For Damp Proof Test, Pure water(Resistance> 10MΩ) should be used.
- 4.In case of malfunction defect caused by ESD damage, if it would be recovered to normal state after resetting, it would be judged as a good part.
- 5.EL evaluation should be excepted from reliability test with humidity and temperature: Some defects such as black spot/blemish can happen by natural chemical reaction with humidity and Fluorescence EL has.
- 6.Failure Judgment Criterion: Basic Specification, Electrical Characteristic, Mechanical Characteristic, Optical Characteristic.
- 7.The finished surface should be free of Drips,Globs,Glue and contamination.
- 8.The paint must adhere to the cover lens and withstand the following test:
Pressure sensitive tape(SCOTCH #610 or equivalent adhesion strength) is applied to the painted surface
And then rapidly removed by pulling at a 90 degree angle to the surface; There should be no evidence of paint seriating from the glass.
- 9.After the reliability test, the product only guarantees operation, but don't guarantee all of the cosmetic specification.

11.INSPECTION CRITERION

Refer to the quality standard on the back of the specification

12. HANDLING PRECAUTIONS

12.1 Mounting method

The LCD module consists of two thin glass plates with polarizers which easily be damaged. And since the module is so constructed as to be fixed by utilizing fitting holes in the printed circuit board.

Extreme care should be needed when handling the LCD modules.

12.2 Caution of LCD handling and cleaning

When cleaning the display surface, Use soft cloth with solvent [recommended below] and wipe lightly :

- .Isopropyl alcohol
- .Ethyl alcohol

Do not wipe the display surface with dry or hard materials that will damage the polarizer surface.

Do not use the following solvent :

- .Water
- .Aromatics

Do not wipe ITO pad area with the dry or hard materials that will damage the ITO patterns

Do not use the following solvent on the pad or prevent it from being contaminated :

- .Soldering flux
- .Chlorine (Cl) , Sulfur (S)

If goods were sent without being silicon coated on the pad, ITO patterns could be damaged due to the corrosion as time goes on.

If ITO corrosion happens by miss-handling or using some materials such as Chlorine (Cl), Sulfur (S) from customer, Responsibility is on customer.

12.3 Caution against static charge

The LCD module uses C-MOS LSI drivers, so we recommend that you :

Connect any unused input terminal to Vdd or Vss, do not input any signals before power is turned on, and ground your body, work/assembly areas, assembly equipment to protect against static electricity.

12.4 Packing

Module employs LCD elements and must be treated as such.

- .Avoid intense shock and falls from a height.
- .To prevent modules from degradation, do not operate or store them exposed direct to sunshine or high temperature/humidity.

12.5 Caution for operation

- .It is an indispensable condition to drive LCD's within the specified voltage limit since the higher voltage than the limit causes the shorter LCD life.
- .An electrochemical reaction due to direct current causes LCD's undesirable deterioration, so that the use of direct current drive should be avoided.
- .Response time will be extremely delayed at lower temperature than the operating temperature range and on the other hand at higher temperature LCD's show dark color in them. However those phenomena do not mean malfunction or out of order with LCD's, which will come back in the specified operation temperature.
- .If the display area is pushed hard during operation, some font will be abnormally displayed but it resumes normal condition after turning off once.
- .A slight dew depositing on terminals is a cause for electro-chemical reaction resulting in terminal open circuit.
- .Usage under the maximum operating temperature, 50%Rh or less is required.
- .When fixed patterns are displayed for a long time, remnant image is likely to occur.

12.6 Storage

In the case of storing for a long period of time for instance, for years for the purpose of replacement use, the following ways are recommended.

- .Storing in an ambient temperature 10°C to 30°C, and in a relative humidity of 45% to 75%. Don't expose to sunlight or fluorescent light.
- .Storing in a polyethylene bag with the opening sealed so as not to enter fresh air outside in it . And with no desiccant.
- .Placing in a dark place where neither exposure to direct sunlight nor light's keeping the storage temperature range.
- .Storing with no touch on polarizer surface by anything else.

It is recommended to store them as they have been contained in the inner container at the time of delivery from us.

12.7 Safety

- .It is recommendable to crash damaged or unnecessary LCD's into pieces and wash off liquid crystal by either of solvents such as acetone and ethanol, which should be burned up later.
- .When any liquid leaked out of a damaged glass cell comes in contact with your hands, please wash it off well with soap and water.

13. PRECAUTION FOR USE

13.1 A limit sample should be provided by the both parties on an occasion when the both parties agreed its necessity. Judgment by a limit sample shall take effect after the limit sample has been established and confirmed by the both parties.

13.2 On the following occasions, the handing of problem should be decided through discussion and agreement between responsible of the both parties.

- .When a question is arisen in this specification.
- .When a new problem is arisen which is not specified in this specifications.
- .When an inspection specifications change or operating condition change in customer is reported to ODNA, and some problem is arisen in this specification due to the change.
- .When a new problem is arisen at the customer's operating set for sample evaluation in the customer site.

14. PACKING SPECIFICATION

Please consult our technical department for detail information.

15. HSF COMPLIANCE

- .This products complies with ROHS 2011/65/EU and 2015/863/EU、REACH 1907/2006/EC requirements, and the packaging complies with 94-62-EC.