

1200-Output Channel TFT LCD Source Driver with TCON

Specification

Preliminary

Version: V0.08
Document No.: ILI6122_SPEC_V008.pdf

ILI TECHNOLOGY CORP.

8F, No. 38, Taiyuan St., Jhubei City,
Hsinchu Country 302 Taiwan R.O.C.
Tel.886-3-5600099; Fax.886-3-5670585
<http://www.ilitek.com>

Table of Contents

Section	Page
1. Introduction.....	4
2. Features	4
3. Block Diagram	6
3.1. Function Block Diagram	6
3.2. Application Block Diagram	7
3.2.1. 800(RGB) x 480 (Gate driver on left side).....	7
3.2.2. 800(RGB) x 600 (Gate driver on left side).....	8
3.2.3. 800(RGB) x 480 (Gate driver on right side).....	9
3.2.4. 800(RGB) x 600 (Gate driver on right side).....	10
4. Pin Descriptions	11
5. Operation Description	16
5.1. Relationship between input data and output channels	16
5.1.1. Stripe Mode	16
5.2. Dot Polarity Inversion	17
5.3. Gate Scan Sequence	18
5.4. CABC (Content Adaptive Brightness Control).....	20
5.5. Application Block Diagram	21
5.6. Display Data Input Timing	23
5.6.1. Vertical Input Timing	23
5.6.2. Horizontal Input Timing.....	23
5.6.2.1. SYNC Mode (MODE="L").....	23
5.6.2.2. DE Mode (MODE="H")	24
5.7. Relationship between gamma correction and output voltage	25
5.8. Power ON/OFF Sequence	27
5.9. Standby ON/OFF Control	28
5.10. The BIST Patterns for Aging Mode Test.....	29
5.11. The Command Format for 3-line Serial Interface.....	30
5.12. Command List	31
5.13. Command Description.....	32
5.13.1. Write Display Brightness Value (51h).....	32
5.13.2. Read Display Brightness Value (52h).....	32
5.13.3. Write CTRL Display Value (53h).....	32
5.13.4. Read CTRL Display Value (54h)	33
5.13.5. Write Content Adaptive Brightness Control Value (82h).....	33
5.13.6. Read Content Adaptive Brightness Control Value (82h)	34
5.13.7. Write CABC Minimum Brightness (5Eh).....	34
5.13.8. Read CABC Minimum Brightness (5Fh).....	34
5.13.9. CABC Control 1 (60h).....	35

5.13.10.	CABC Control 2 (61h).....	36
5.13.11.	CABC Control 3 (62h).....	37
5.13.12.	CABC Control 4 (63h).....	38
5.13.13.	CABC Control 5 (64h).....	39
5.13.14.	CABC Control 6 (65h).....	39
6.	DC Characteristic	40
6.1.	Absolute Maximum Rating (DGND = AGND=0V, Ta=25°C).....	40
6.2.	DC Electrical Characteristics (DGND=AGND=0V, Ta=25°C)	40
7.	AC Characteristics	41
7.1.	AC Timing characteristics.....	41
7.2.	Display Timing characteristics.....	45
7.2.1.	Resolution: 800x480.....	45
7.2.2.	Resolution: 800x600.....	47
8.	Pad Sequence (Bump Side).....	48
9.	Pad Arrangement and Coordination.....	49
10.	Revision History	57

1. Introduction

ILI6122 is a 1200-channel output source driver with TTL interface timing controller (TCON). The interface follows digital 24-bit parallel RGB input format. The TCON generates the 800x480 and 800x600 resolutions and provides horizontal and vertical control timing to source driver and gate driver. It also supports dithering feature, apply source driver with 6-bit DAC to perform 8-bit resolution 256 gray scales. Operating parameters can be set via pin control for all control features. Since the output circuit of this source driver incorporates an operational amplifier with low power dissipation, and performs wide voltage supply range and small output deviation.

ILI6122 can be configured as dual-gate operation mode for reducing FPC amount and saving the cost. With wide range of supply voltages and many pin control features make this chip mode suitable for various applications.

2. Features

◆ TCON

- Supports display resolution 800x480 and 800x600
- Supports digital 24-bit parallel RGB input mode
- Supports to configure CABC block via 3-line SPI mode
- Source output with 8-bit resolution for 256 gray scales (2-bit dithering)
- Supports dual-gate operation mode
- Supports Stripe CF configuration
- Maximum Operation frequency: 50 MHz
- Provide flip and mirror scan mode by pin control
- Supports stand-by mode for saving power consumption
- Operation Voltage Level 3.0V to 3.6V
- Hardware Pin Control CABC Mode Selection

◆ Source Driver

- 1200 channels output source driver for TFT LCD panel
- Embedded custom-made Gamma table for special custom request
- Supports external V1~V14 pad for Gamma adjustment
- Output dynamic range : 0.1 ~ VDDA-0.1V
- Voltage deviation of outputs: $\pm 20\text{mV}$
- Power for source driver voltage (VDDA) : 6.5V ~ 13.5V

◆ **Others**

- COG package
- Supports CABC (Content Adaptive Brightness Control) function

3. Block Diagram

3.1. Function Block Diagram

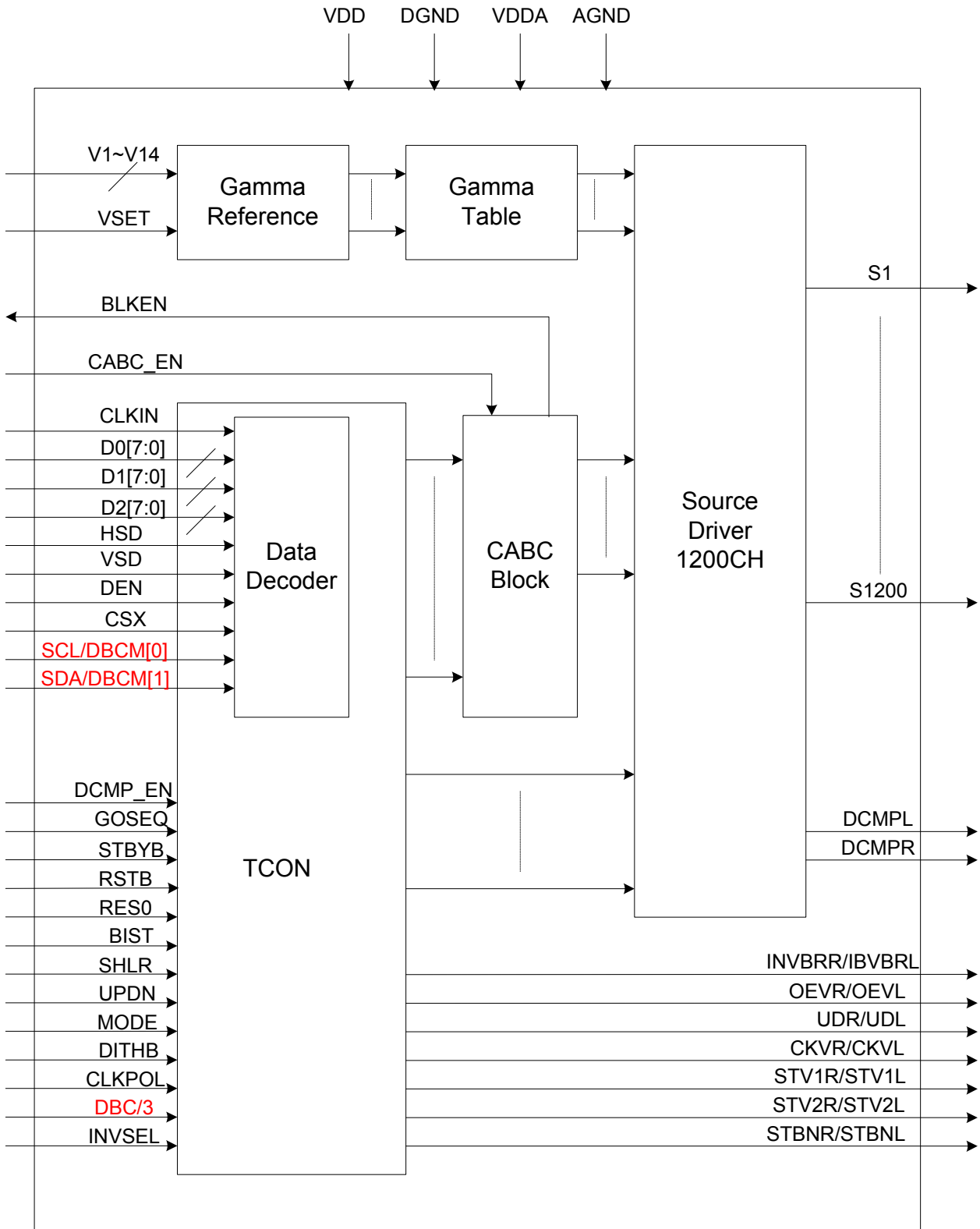

3.2. Application Block Diagram

3.2.1. 800(RGB) x 480 (Gate driver on left side)

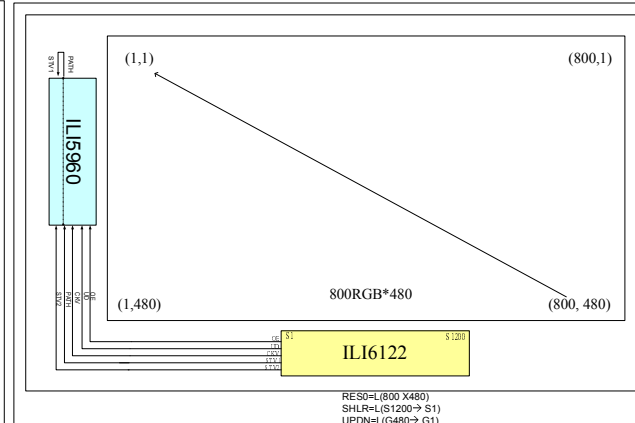
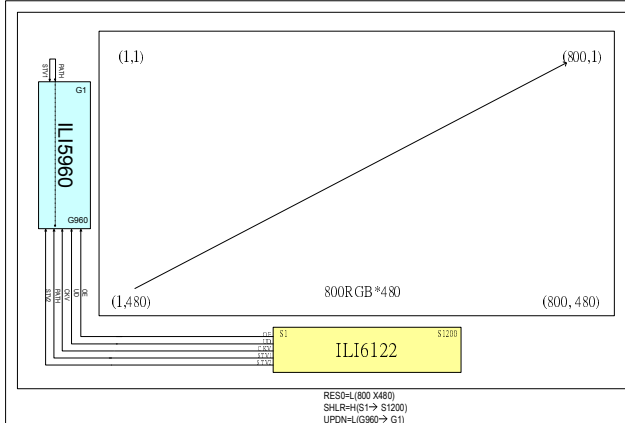
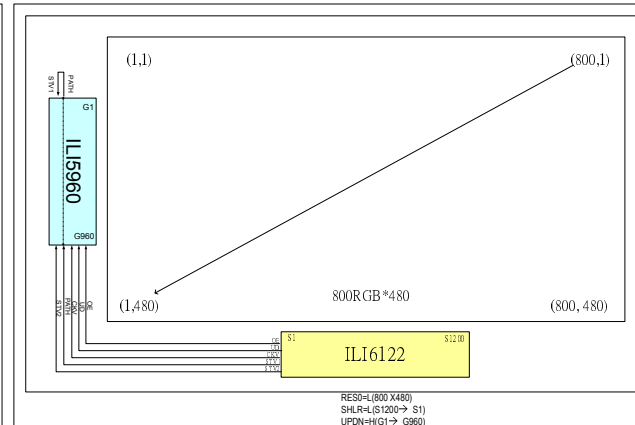
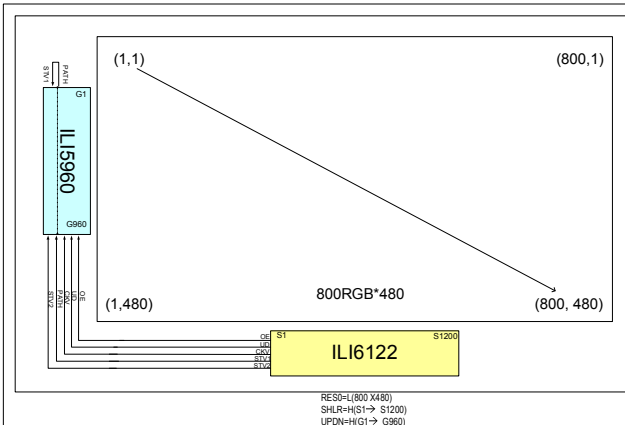
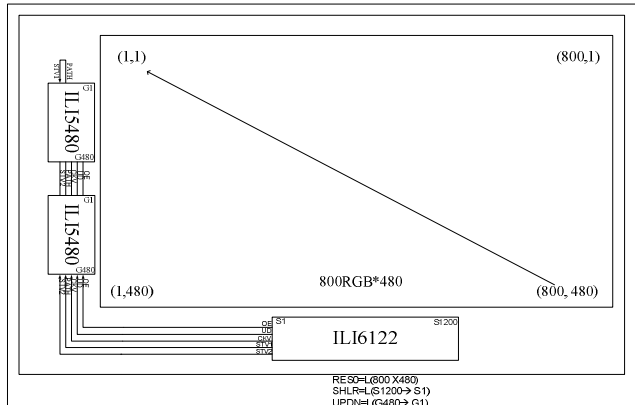
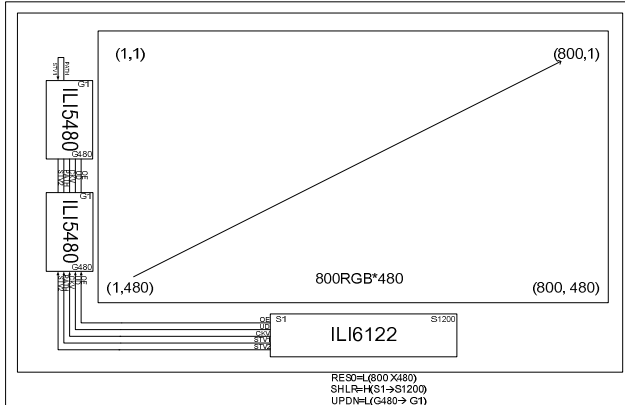
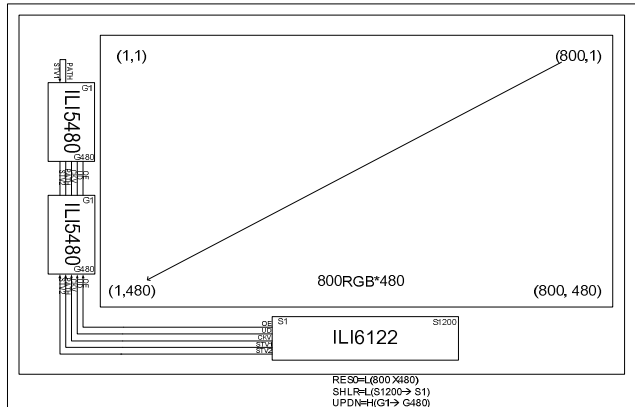
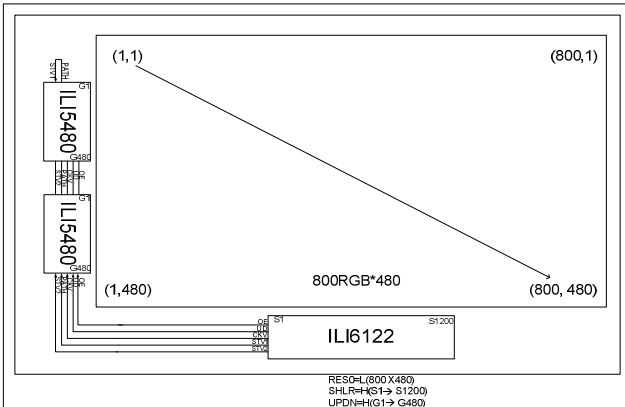

3.2.2. 800(RGB) x 600 (Gate driver on left side)

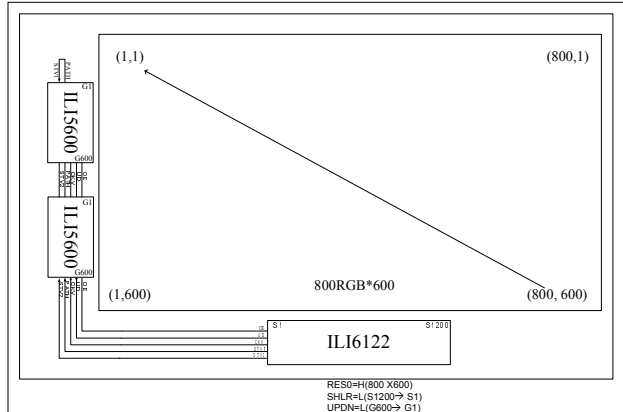
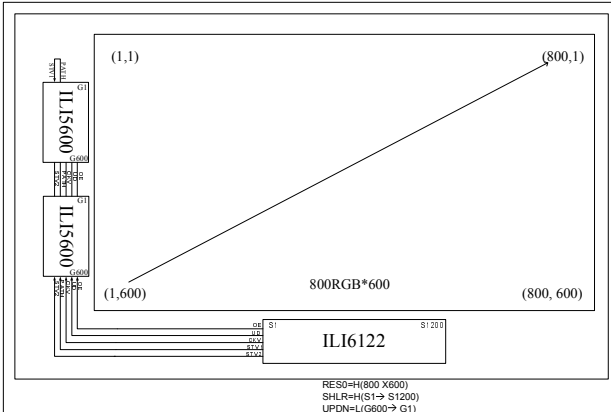
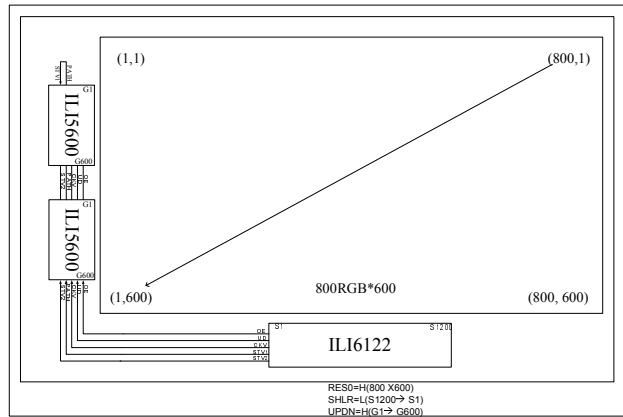
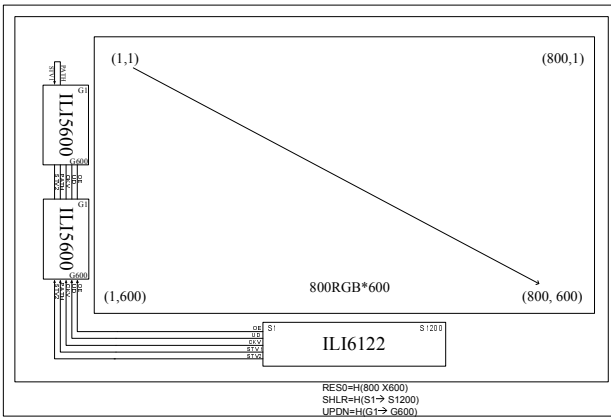

3.2.3. 800(RGB) x 480 (Gate driver on right side)

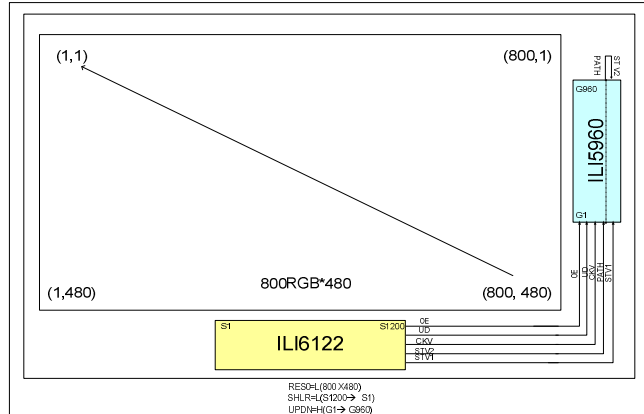
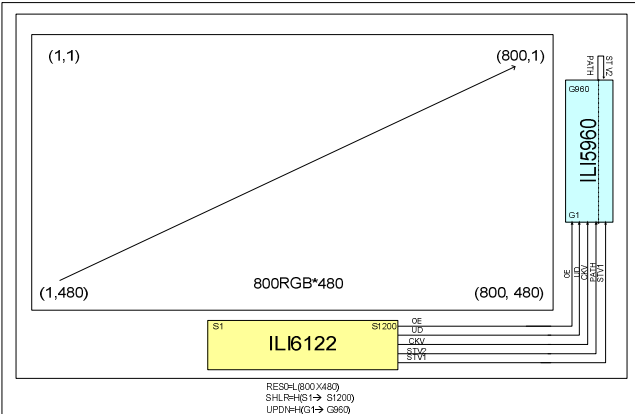
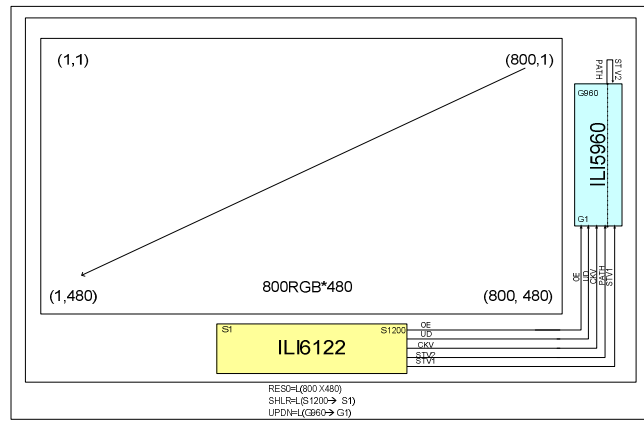
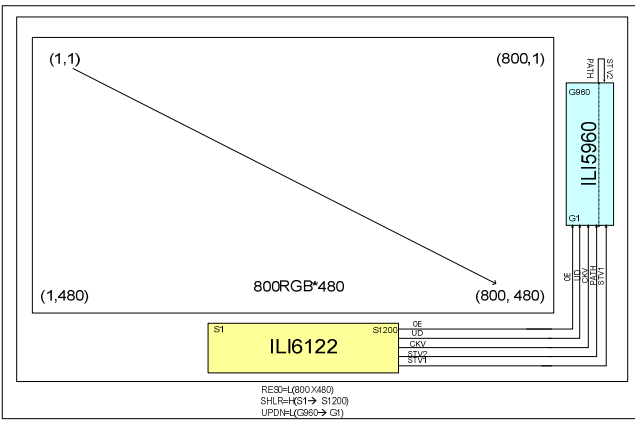
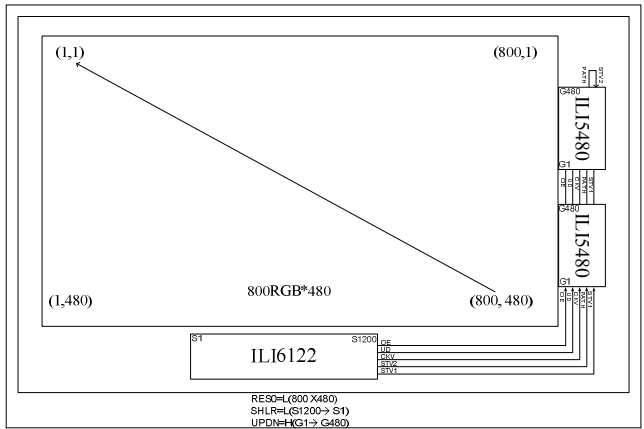
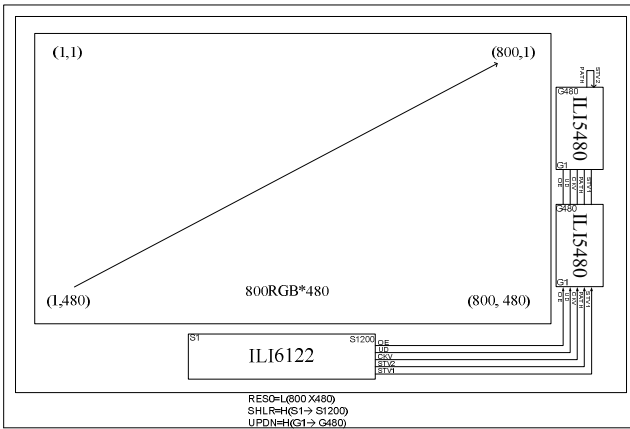
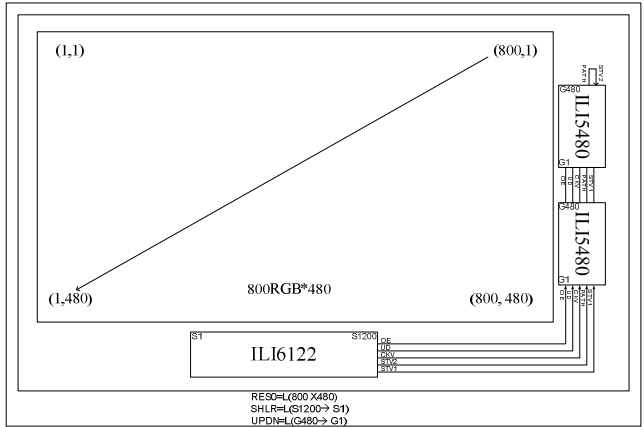
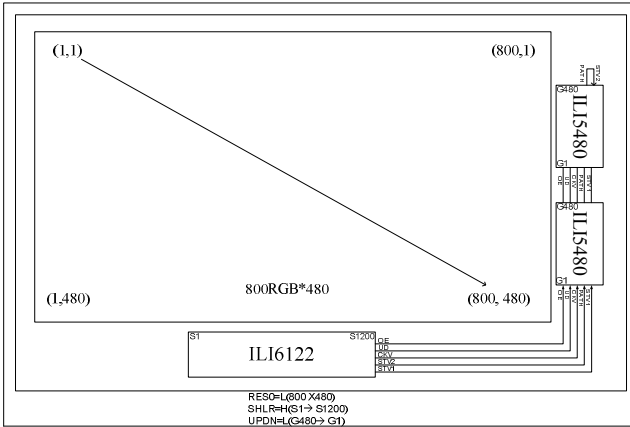

3.2.4. 800(RGB) x 600 (Gate driver on right side)

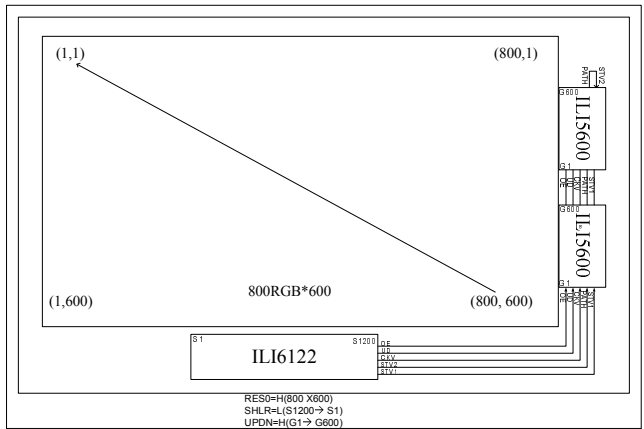
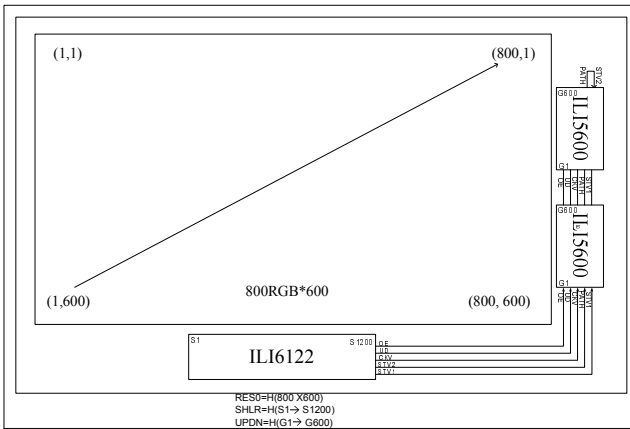
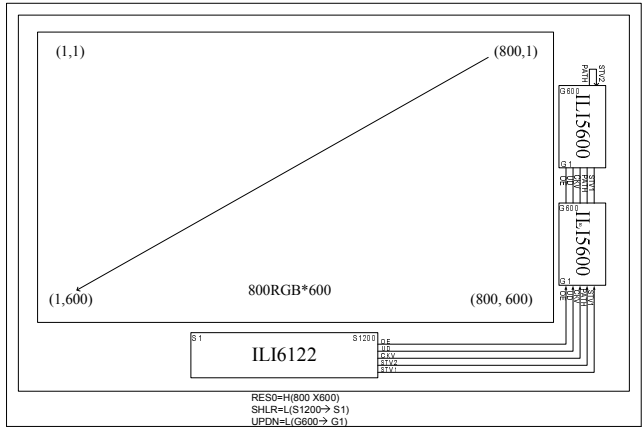
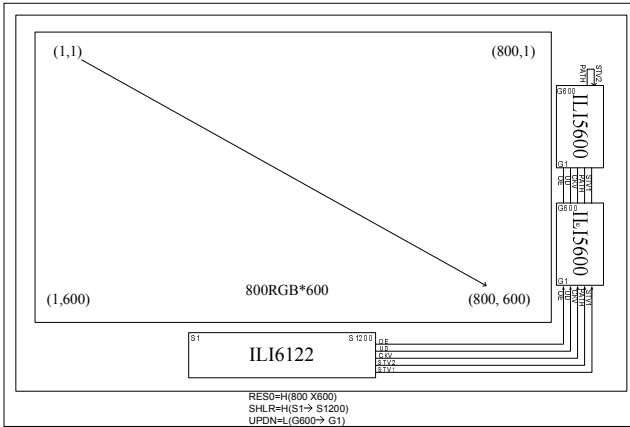

4. Pin Descriptions

Pin Name	I/O	Descriptions
CLKIN	I	Clock for input data. Data latched at rising/falling edge of this signal. Default is falling edge.
D0[7:0] D1[7:0] D2[7:0]	I	Digital data input. Dx0 is LSB and Dx7 is MSB. D0[7:0] = R[7:0] data; D1[7:0] = G[7:0] data; D2[7:0]=B[7:0] data When 18-bit RGB interface (disable dithering function), please use Dx[7:2] as 6-bit input and connect Dx[1:0] to DGND.
HSD	I	Horizontal sync input in digital parallel RGB. Negative polarity.
VSD	I	Vertical sync input in digital parallel RGB. Negative polarity.
DEN	I	Input data enable control. When DE mode, active High to enable data input. (Normally pull low)
MODE	I	DE / SYNC mode select. (Normally pull high) MODE="L", for entering SYNC mode. MODE="H", for entering DE mode.
CSX	I	A chip select signal. (Normally pull high) CSX="L", the chip is selected and accessible CSX="H", the chip is not selected and not accessible Fix to the VDD level when not in use.
SCL/DBC[M][0]	I	Multi-Function Selection: When DBC/3="H", this pin act as 3-wire "SCL" pin. Serial clock input. This pin is used for CABC command set only. When DBC/3="L", this pin act as DBC mode select pin LSB (DBC[M][0]) Note: Normal pull high and Fix to the VDD level when not in use.
SDA/DBC[M][1]	I/O	Multi-Function Selection: When DBC/3="H", this pin act as 3-wire "SDA" pin. Serial data input / output. This pin is used for CABC command set only. When DBC/3="L", this pin act as DBC mode select pin MSB (DBC[M][1]) Note: Normal pull high and Fix to the VDD level when not in use.
RSTB	I	Hardware global reset. Low active. (Normally pull high)
INVSEL	I	The driving polarity inversion select. This pin is used for CABC command set only. (Normally pull low) INVSEL="L", 2-dot inversion. INVSEL="H", 1-dot inversion
RES0	I	Display resolution selection. (Normally pull low) RES0="L", for 800(RGB)x480 display resolution. RES0="H", for 800(RGB)x600 display resolution.

Pin Name	I/O	Descriptions
DITHB	I	Dithering function enable control. (Normally pull high) DITHB="L", to enable internal dithering function. DITHB="H", to disable internal dithering function.
CLKPOL	I	Input clock edge selection. (Normally pull low) CLKPOL="L", latch data at CLKIN falling edge. CLKPOL="H", latch data at CLKIN rising edge.
DBC/3	I	DBC/3-wire selection pin(Normal pull high) DBC/3="L", Select DBC hardware control function. DBC/3="H", Select 3-wire SPI interface function.
V1 ~ V14	I/O	When VSET="L", the internal Gamma table is used and V1~V14 pins are unused. When VSET="H", V1~V14 pins are the external adjustment point for Gamma correction. The relationship between V1~V14 must be : AGND<V14<V13<V12<V11<V10<V9<V8<V7<V6<V5<V4<V3<V2<V1<VDDA
GOSEQ	I	Gate on sequence. (Normally pull low) GOSEQ="L", INVBRR/INVBRL will output "H" and gate on sequence is "G1→G2→G3→G4→G5→G6→G7→G8→.....→G _{n-3} →G _{n-2} →G _{n-1} →G _n " GOSEQ="H", INVBRR/INVBRL will output "L" and gate on sequence is "G1→G2→G4→G3→G5→G6→G8→G7→.....→G _{n-3} →G _{n-2} →G _n →G _{n-1} "
VSET	I	Gamma correction source select. (Normally pull low) VSET="L", to use internal Gamma reference voltage (VDDA). VSET="H", to use external Gamma correction input (V1~V14).
DCMP_EN	I	DCMP enable control signal. (Normally pull high) DCMP_EN="L", the DCMP_L/DCMP_R signals are disable. DCMP_EN="H", the DCMP_L/DCMP_R signals are enable.
STBYB	I	Standby mode control. (Normally pull high) STBYB="L", enter standby mode for power saving. Timing controller and source driver will turn off, all outputs are Hi-Z. STBYB="H", normal operation.
SHLR	I	Source shift direction control. (Normally pull high) SHLR="L", shift direction is "S1200 → S1199 → 1198 → ... S3 → S2 → S1" SHLR="H", shift direction is "S1 → S2 → S3 → ... → S1198 → S1199 → S1200".
UPDN	I	Gate scan direction control (Normally pull high) UPDN="L", STV2 outputs the vertical start pulse and UD pin outputs "L" to Gate driver. UPDN="H", STV1 outputs the vertical start pulse and UD pin outputs "H" to Gate driver.

Pin Name	I/O	Descriptions
BIST	I	Normal operation / BIST pattern select. (Normally pull low) BIST="L", Normal operation BIST="H", BIST (DCLK input is not needed)
CABC_EN	I	CABC function enable control. (Normally pull low) CABC_EN="L", BLKEN pin is used to be backlight control signal for external backlight controller. CABC_EN="H", ILI6122 will refer the gray scale content of display image to output a PWM frequency to LED driver via BLKEN pin.
BLKEN	O	The backlight control signal for external backlight controller. BLKEN="L", turn off the external backlight controller. BLKEN="H", turn on the external backlight controller. Note : Refer to the Power ON/OFF sequence for the detail information when CABC_EN is set to "L". Note: Keep Open when not in use.
OEVR/OEVL	O	Gate driver control signal.
UDR/UDL	O	Gate driver control signal.
CKVR/CKVL	O	Gate driver control signal.
STV1R/STV1L	O	Gate driver control signal.
STV2R/STV2L	O	Gate driver control signal.
STBNR/STBNL	O	Gate driver control signal.
INVBRR/INVBRL	O	Gate driver control signal.
DCMPL/DCMPR	O	Data line compensation.
VDDA	P	Power supply for analog block.
AGND	P	Ground level for analog block.
VDD	P	Power supply for digital block.
DGND	P	Ground level for digital block.
S1 ~ S1200	O	Source driver output signals.
ALIGN	--	For assembly alignment.
COM1_B COM2_B	--	COM1_B and COM2_B are short-circuited within ILI6122 for contact resistance measurement. Please leave it open when not in use.
COM1_T COM2_T	--	COM1_T and COM2_T are short-circuited within ILI6122 for contact resistance measurement. Please leave it open when not in use.
TP0 ~ TP5	I	Test pins, not accessible to user, must be left open. (Normally pull low)
TP6 ~ TP10	O	Test pins, not accessible to user, must be left open.
SHIELDING	--	IC shielding pads. Those pins are internally connected to AGND level.
DASHD	--	Data bus shielding pad. Those pins are internally connected to DGND level.
DUMMY	--	Dummy pads. Please leave it open when not in use.
FB	--	Reserved pins, not accessible to user.

Pin Name	I/O	Descriptions
DRV	--	Reserved pins, not accessible to user.
PWM_EN	--	Reserved pins, not accessible to user. (Normally pull low)

DBC/3 for CABC Function Control description:

Pin Name	DBC/3			
	H (Default)	L		
CSX	Enable SPI Function	Disable SPI Function, CABC Function mode by Hardware Pin control		
SCL/DBC[0]		SDA/DBC[1]	SCL/DBC[0]	Mode
		0	0	User interface image
		0	1	CABC OFF
		1	0	Moving image
		1	1	Still picture
SDA/DBC[1]		Remark: Default Still Mode		

Note: (1) Please power on following the sequence VDD → logic input → VDDA and V1 ~ V14. Reverse the sequence to shut down.

(2) To stabilize the supply voltages, please be sure to insert a 0.1uF bypass capacitor between

VDD↔DGND and VDDA↔AGND. Furthermore, for increased precision of the D/A converter, insertion of a bypass capacitor of about 0.01uF is also advised between the gamma-corrected power supply terminals (V1, V2, ..., V14) and AGND.

(3) Please keep V1~V14 not cross to the toggle signals as possible to avoid the AC coupling on the DC V1~V14 voltage. When used as cascade mode, please keep the coupled amount of V1~V10 are the same between the two chips.

(4) The input wiring resistance values affect power or signal integrity and the display quality. So be sure to design using values that do not exceed those recommended as below.

Pin Name	Wiring resistance value(Ω)
VDDA	< 5
AGND	< 5
VDD	< 10
DGND	< 10
V1 ~ V14	< 10
Dx[0:7]	< 50
CLKIN	< 50
VSD	< 50
HSD	< 50
DEN	< 50
BLK_EN	< 200
CSX	< 200
SCL/DBCM[0]	< 200
SDA/DBCM[1]	< 200
RESX	< 500
STBYB	< 500
DITHB	< 500
SHLR	< 500
UPDN	< 500
BIST	< 500
MODE	< 500
RES0	< 500
CLKPOL	< 500
DBC/3	< 500
VSET	< 500
INVBRR/INVBRL	< 500
OEVR / OEVL	< 500
UDR / UDL	< 500
CKVR / CKVL	< 500
STV1R / STV1L	< 500
STV2R / STV2L	< 500
STV2R / STV2L	< 500
STBNR / STBNL	< 500
Others	< 500

5. Operation Description

5.1. Relationship between input data and output channels

5.1.1. Stripe Mode

The relationship between input display data and source output channels is illustrated as below:

SHLR="L", Left Shift Direction							
Output	S1	S2	S3	←	S1198	S1199	S1200
Order	Last data			---	First data		
Odd Line / G _n	D0[7:0]	D2[7:0]	D1[7:0]	---	D0[7:0]	D2[7:0]	D1[7:0]
Odd Line / G _{n+1}	D1[7:0]	D0[7:0]	D2[7:0]	---	D1[7:0]	D0[7:0]	D2[7:0]
Even Line / G _n	D0[7:0]	D2[7:0]	D1[7:0]	---	D0[7:0]	D2[7:0]	D1[7:0]
Even Line / G _{n+1}	D1[7:0]	D0[7:0]	D2[7:0]	---	D1[7:0]	D0[7:0]	D2[7:0]

SHLR="H", Right Shift Direction							
Output	S1	S2	S3	→	S1198	S1199	S1200
Order	First data			---	Last data		
Odd Line / G _n	D0[7:0]	D2[7:0]	D1[7:0]	---	D0[7:0]	D2[7:0]	D1[7:0]
Odd Line / G _{n+1}	D1[7:0]	D0[7:0]	D2[7:0]	---	D1[7:0]	D0[7:0]	D2[7:0]
Even Line / G _n	D0[7:0]	D2[7:0]	D1[7:0]	---	D0[7:0]	D2[7:0]	D1[7:0]
Even Line / G _{n+1}	D1[7:0]	D0[7:0]	D2[7:0]	---	D1[7:0]	D0[7:0]	D2[7:0]

5.2. Dot Polarity Inversion

ILI6122 supplies both of 1-dot and 2-dot inversion, the pixel polarity inversion was illustrated as below:

1-dot Inversion, INVSEL="H" & GOSEQ="L"

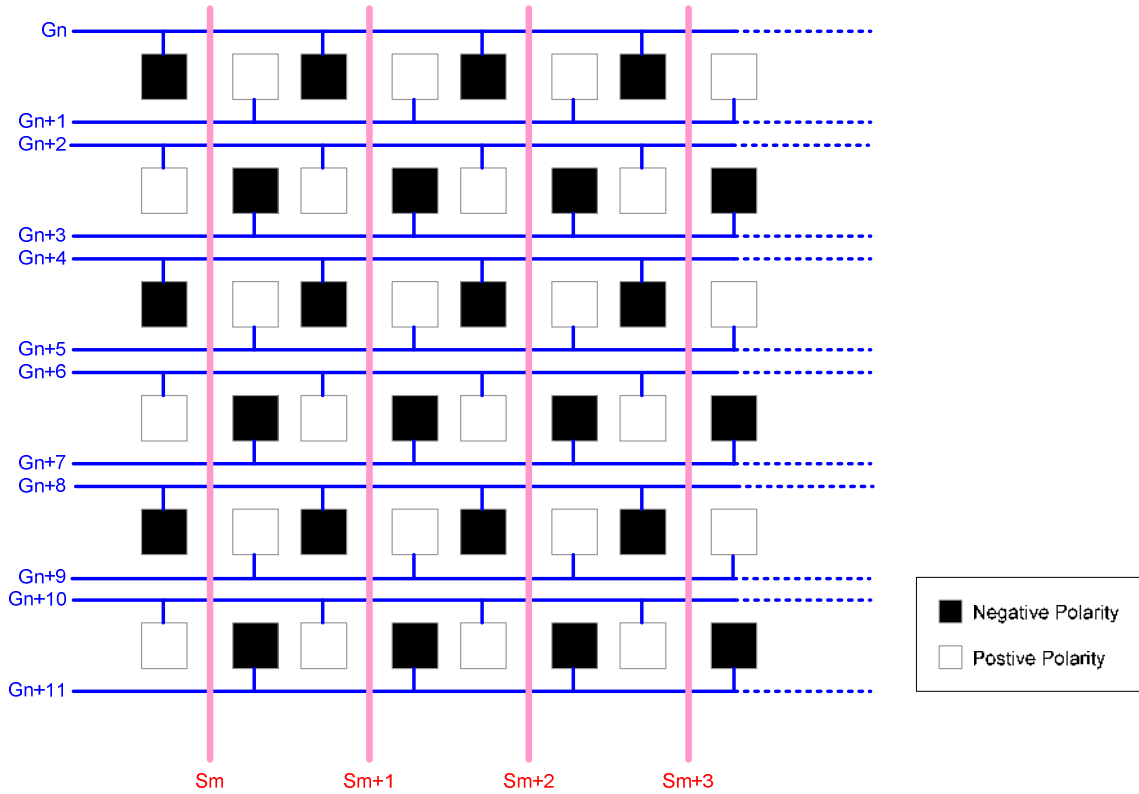

2-dot Inversion, INVSEL="L" & GOSEQ="L"

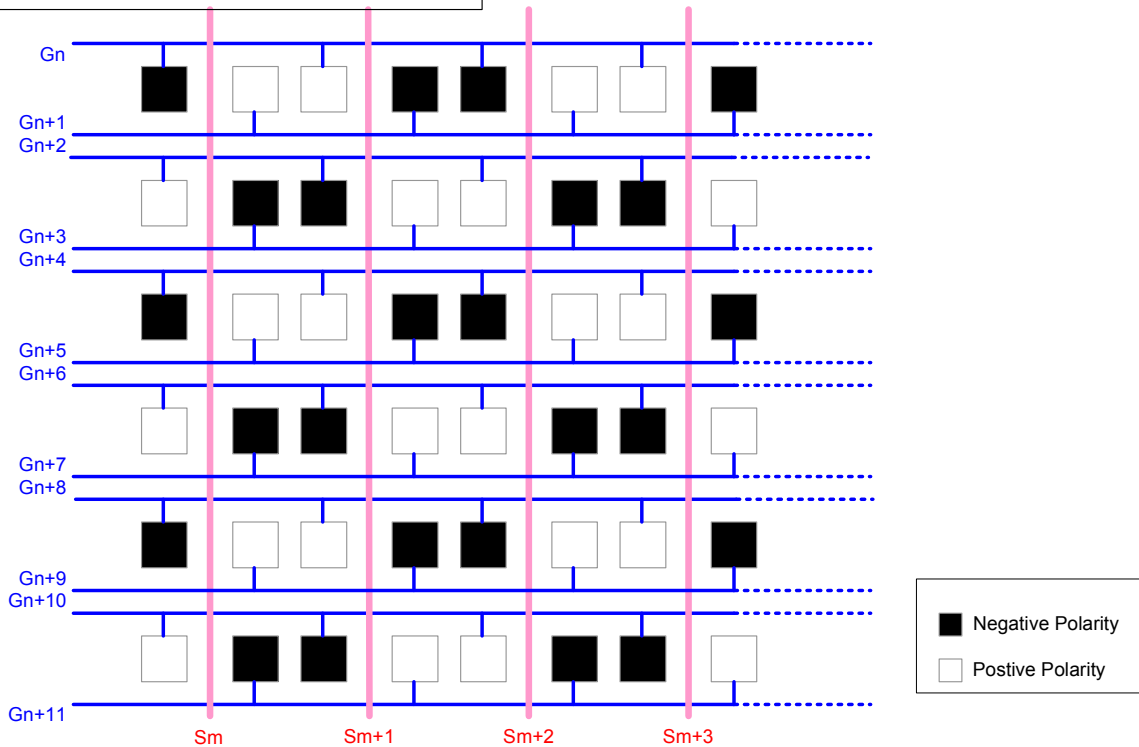

5.3. Gate Scan Sequence

Based on special panel request, ILI6122 supports two kinds of gate scan sequences and illustrated as below:

GOSEQ="L" & UPDN="H" → INVBR/INVBRL="H" (Traditional Scan, For General Gate Driver)

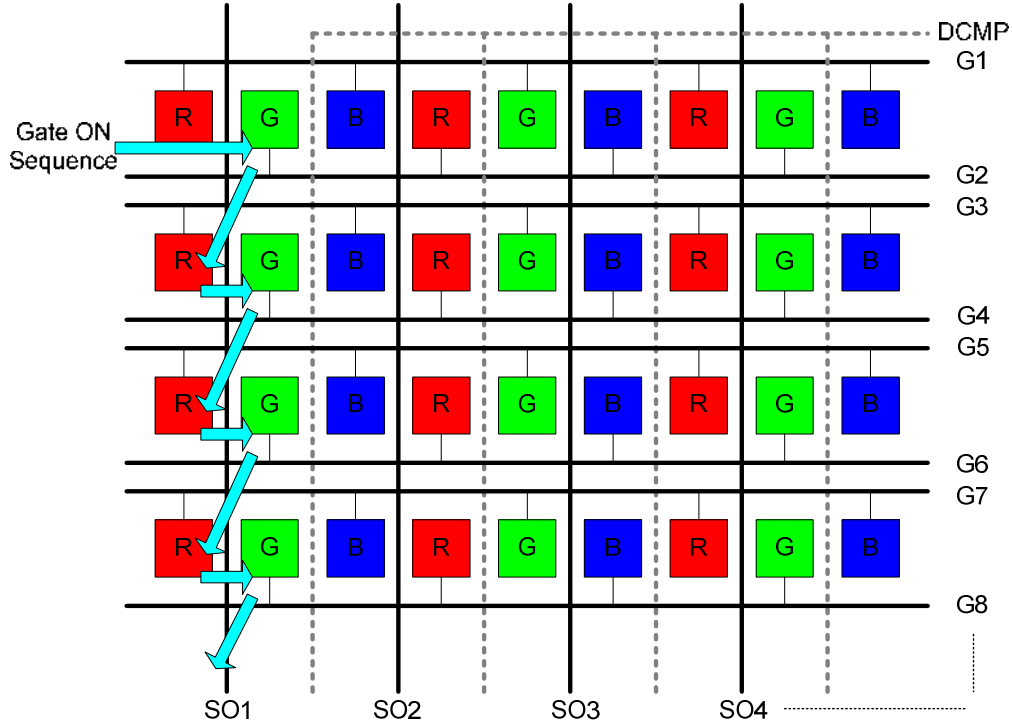

GOSEQ="H" & UPDN="H" → INVBR/INVBRL="L" (Bow-shaped Scan, For Special Gate Driver)

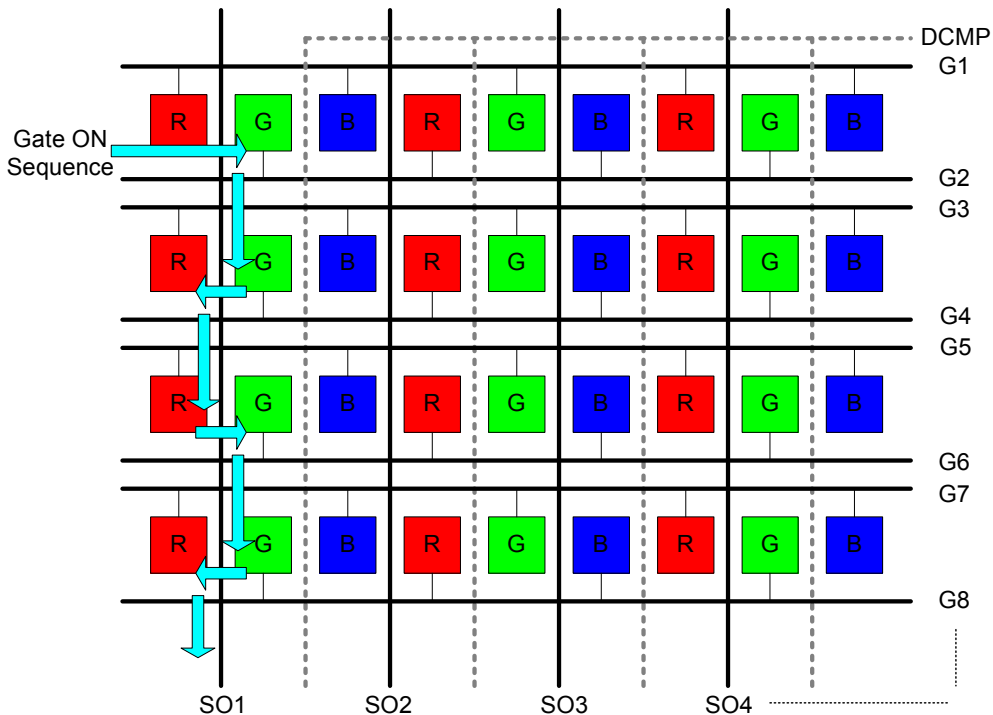

GOSEQ="L" & UPDN="L" → INVBR/INVBRL="H" (Traditional Scan, For General Gate Driver)

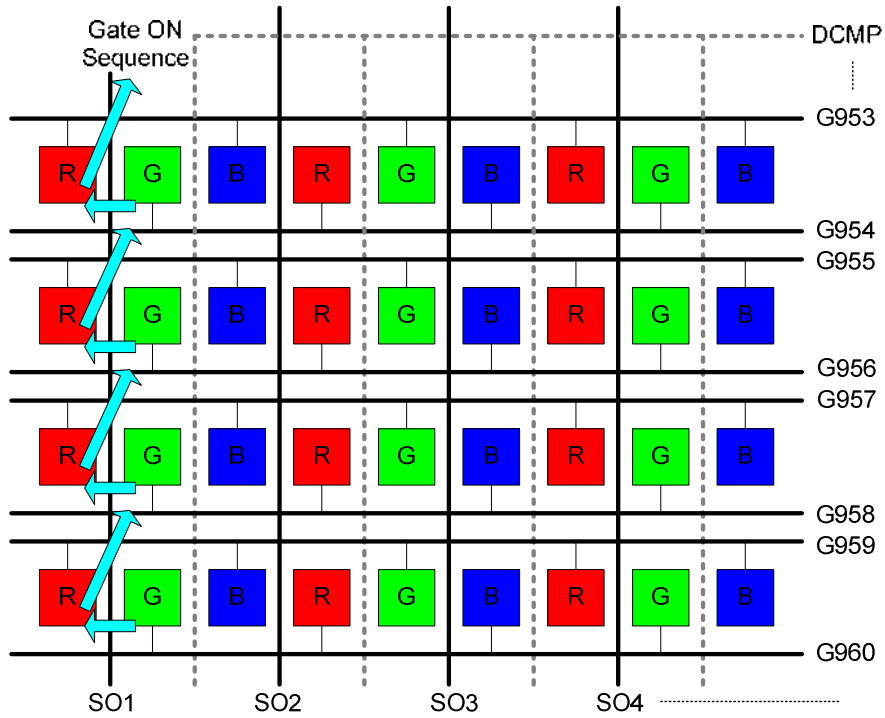

GOSEQ="H" & UPDN="L" → INVBR/INVBRL="L" (Bow-shaped Scan, For Special Gate Driver)

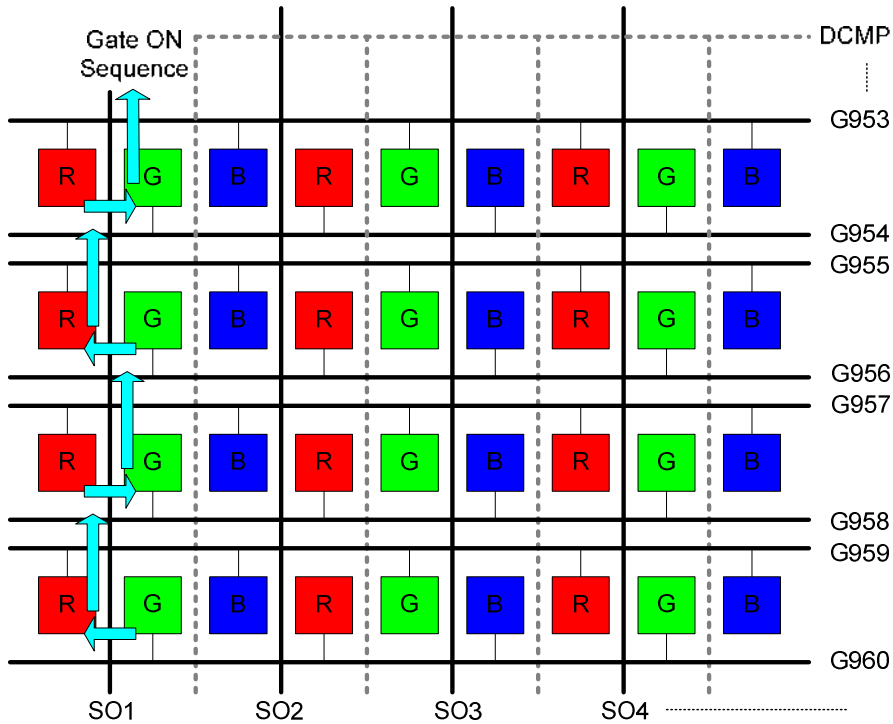

5.4. CABC (Content Adaptive Brightness Control)

ILI61220 provides a dynamic backlight control function as CABC (Content adaptive brightness control) to reduce the power consumption of the luminance source. ILI6122 will refer the gray scale content of display image to output a PWM waveform to LED driver for backlight brightness control. Content adaptation means that the content of gray sale can be increased while simultaneously lowering brightness of the backlight to achieve the same perceived brightness. The adjusted gray level scale and thus the power consumption reduction depend on the content of the image.

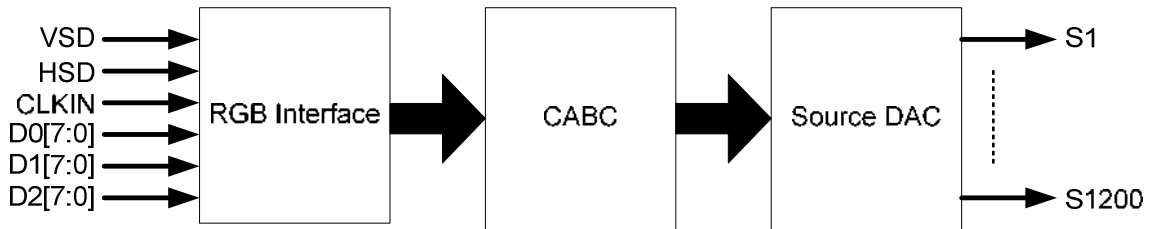

The CABC function can be turned ON/OFF via external pin as CABC_EN and also can be configured by software commands via SPI mode for performance optimization. IL6122 can calculate the backlight brightness level and send a PWM pulse to LED driver via **BLKEN** pin for backlight brightness control purpose. The figure in the following is the basic timing diagram which is applied ILI6122 to control LED driver.

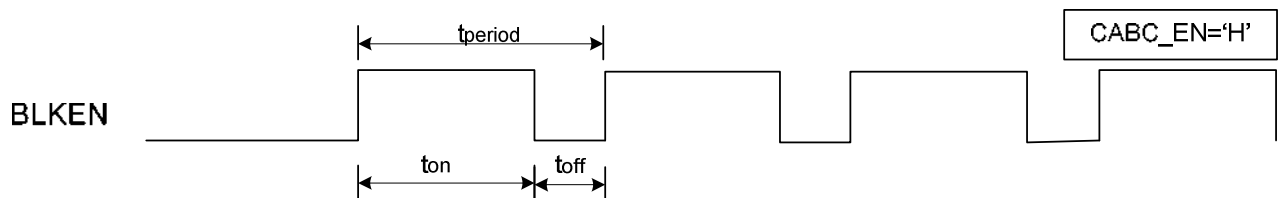

5.6. Display Data Input Timing

5.6.1. Vertical Input Timing

ILI6122 provides two different interface modes, SYNC mode and DE mode. Both modes can be selected by MODE pin, ILI6122 will enter the SYNC mode while MODE pin is set to 'L' and enter DE mode while MODE pin is set to 'H'.

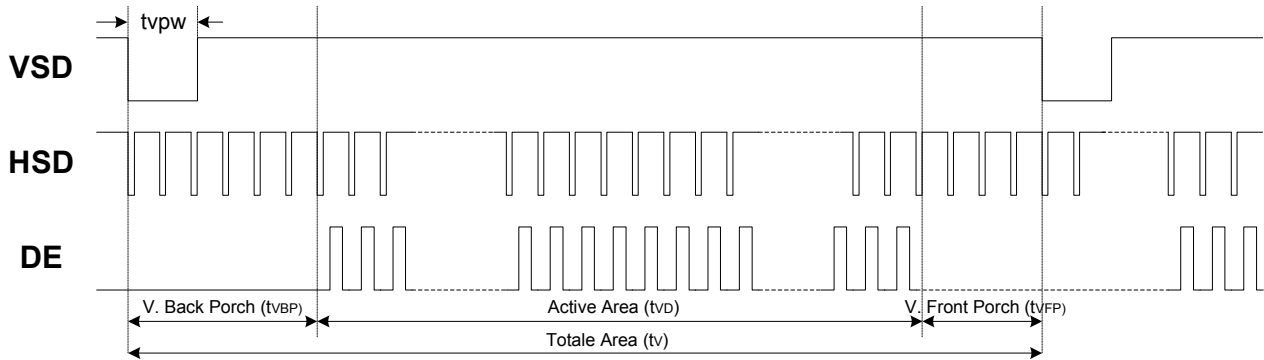

5.6.2. Horizontal Input Timing

5.6.2.1. SYNC Mode (MODE="L")

ILI6122 will enter SYNC mode while MODE pin is fixed at "L" level. Every HSD period is consists of Horizontal Back Porch, Active Area and Horizontal Front Porch time. The first active display data is transmitted at the first falling/rising edge of CLKIN after Horizontal Back Porch period and the last display data is transmitted at the last falling/rising edge of CLKIN before Horizontal Front Porch period.

ILI6122 will latch the display data on Dx[7:0] bus at falling edge of CLKIN when CLKPOL is set to "L", the input data timing is illustrated as below:

CLKPOL= "L"

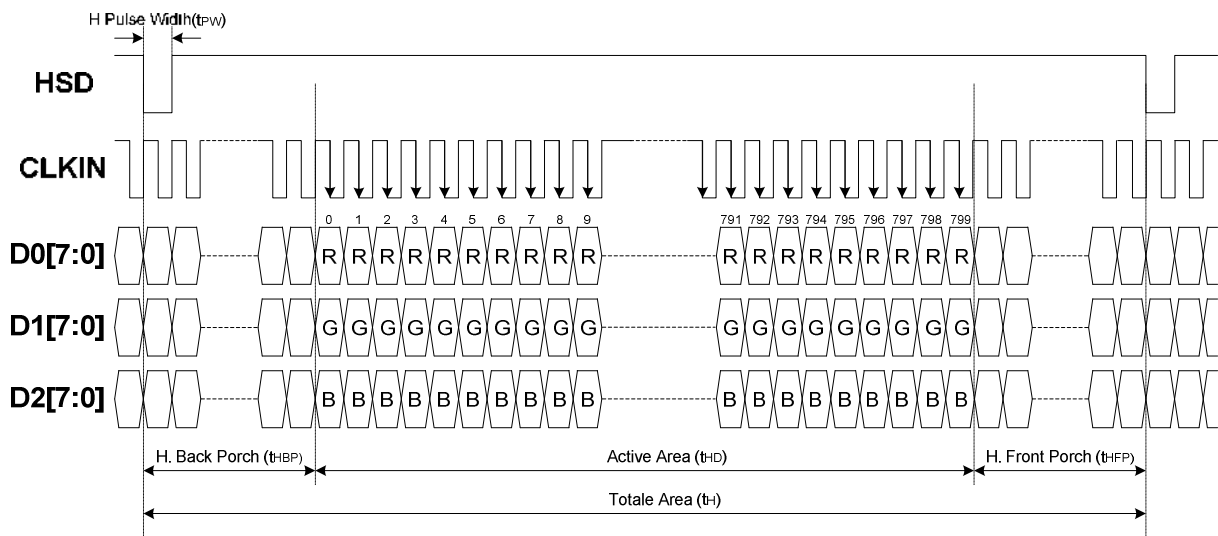

ILI6122 will latch the display data on Dx[7:0] bus at rising edge of CLKIN when CLKPOL is set to "H", the input data timing is illustrated as below:

CLKPOL= "H"

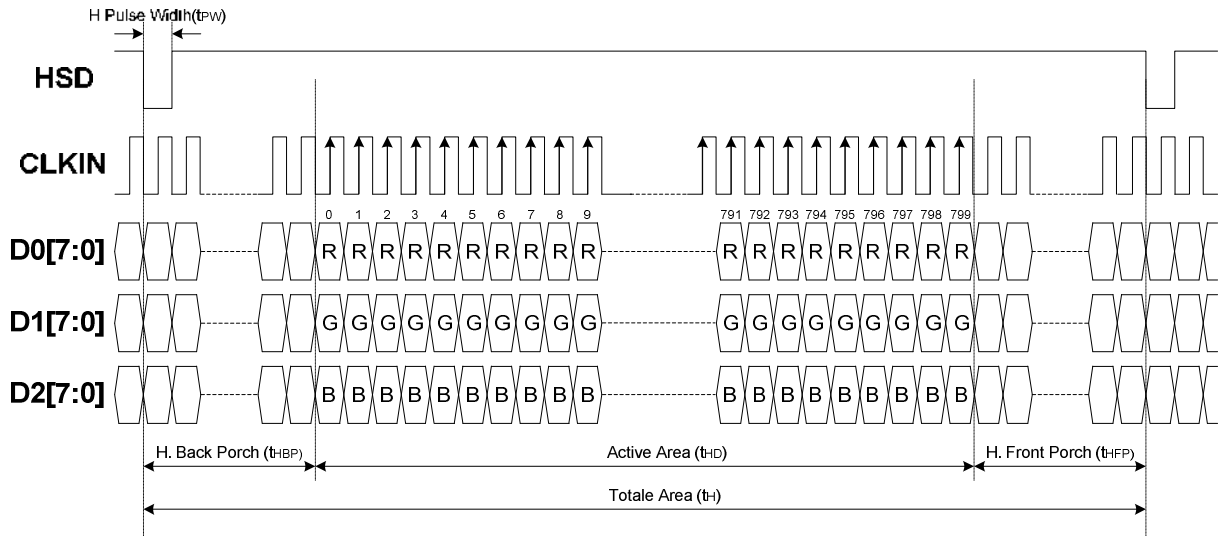

5.6.2.2. DE Mode (MODE="H")

ILI6122 will enter DE mode while MODE pin is fixed at "H" level. ILI6122 will treat the data on Dx[7:0] bus as active display data while DEN is at "H" level and ignore the data on Dx[7:0] bus while DEN is at "L" level.

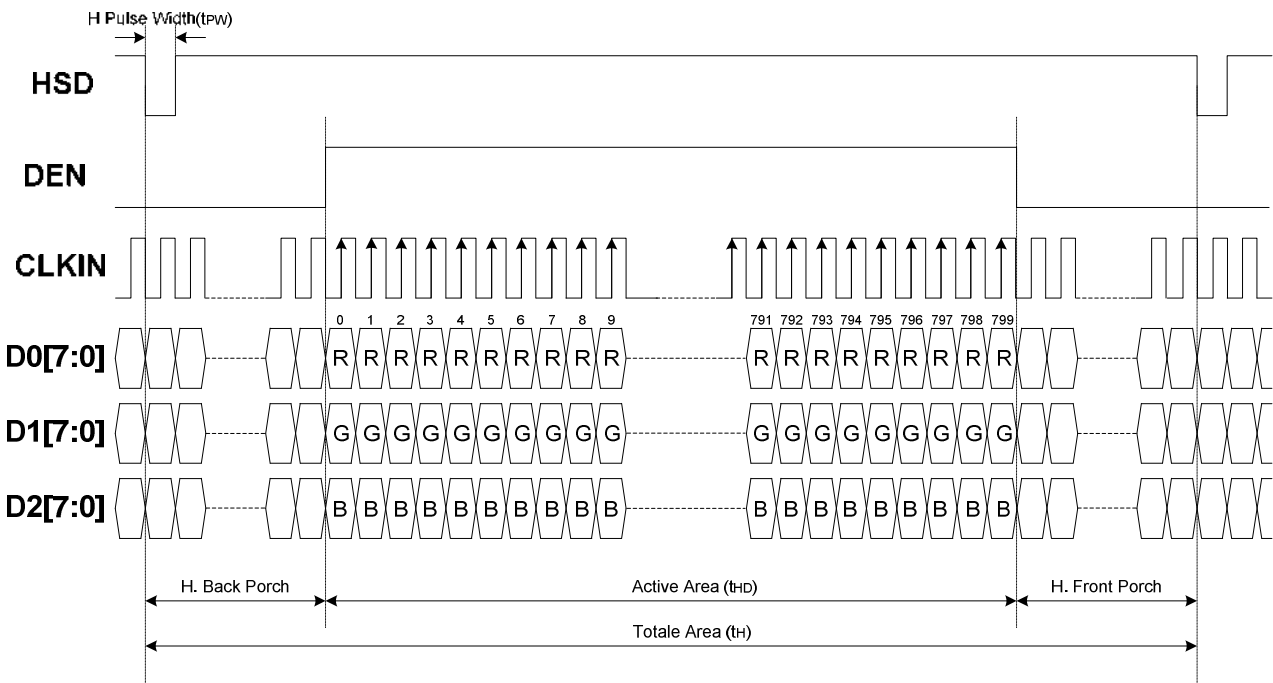

5.7. Relationship between gamma correction and output voltage

The output voltage is determined by the 6-bit digital input data, and the V1 ~ V14 gamma correction reference voltage inputs. The figure in the following shows the relationship between the input data and the output voltage. Refer the next page for the relative values and voltage calculation method.

Gamma correction characteristic curve:

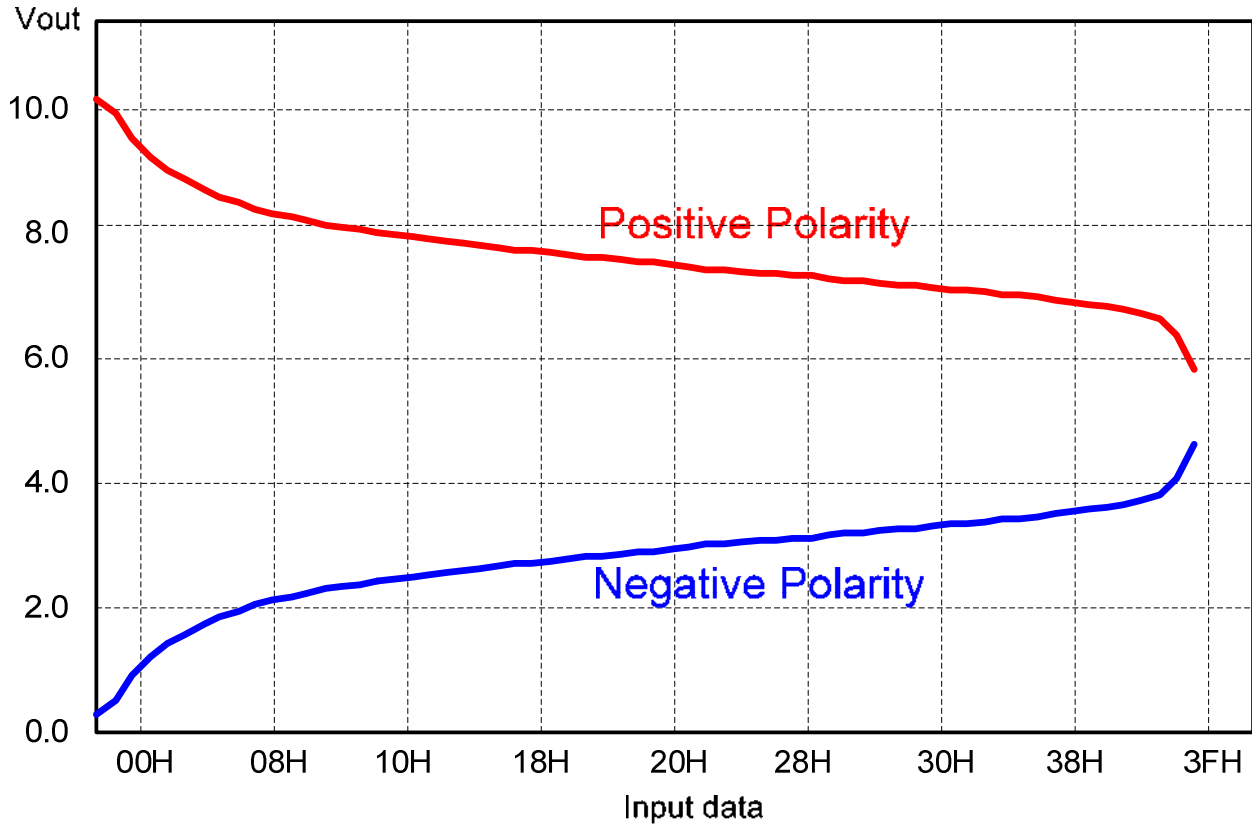

Note : $VDDA-0.1 \geq V1 \geq V2 \geq V3 \geq V4 \geq V5 \geq V6 \geq V7 \geq V8 \geq V9 \geq V10 \geq V11 \geq V12 \geq V13 \geq V14 \geq AGND+0.1$

The internal Gamma Table is shown as below. (VSET="L")

Display Data (Hex)	Positive Polarity	Negative Polarity
00h	VDDA x 0.961	VDDA x 0.019
01h	VDDA x 0.937	VDDA x 0.045
02h	VDDA x 0.903	VDDA x 0.081
03h	VDDA x 0.880	VDDA x 0.106
04h	VDDA x 0.861	VDDA x 0.126
05h	VDDA x 0.847	VDDA x 0.142
06h	VDDA x 0.836	VDDA x 0.155
07h	VDDA x 0.826	VDDA x 0.166
08h	VDDA x 0.818	VDDA x 0.176
09h	VDDA x 0.810	VDDA x 0.184
0Ah	VDDA x 0.804	VDDA x 0.192
0Bh	VDDA x 0.798	VDDA x 0.199
0Ch	VDDA x 0.793	VDDA x 0.205
0Dh	VDDA x 0.788	VDDA x 0.211
0Eh	VDDA x 0.783	VDDA x 0.217
0Fh	VDDA x 0.779	VDDA x 0.222
10h	VDDA x 0.775	VDDA x 0.227
11h	VDDA x 0.772	VDDA x 0.231
12h	VDDA x 0.768	VDDA x 0.236
13h	VDDA x 0.765	VDDA x 0.240
14h	VDDA x 0.762	VDDA x 0.244
15h	VDDA x 0.759	VDDA x 0.248
16h	VDDA x 0.757	VDDA x 0.252
17h	VDDA x 0.754	VDDA x 0.256
18h	VDDA x 0.751	VDDA x 0.259
19h	VDDA x 0.749	VDDA x 0.263
1Ah	VDDA x 0.746	VDDA x 0.266
1Bh	VDDA x 0.744	VDDA x 0.269
1Ch	VDDA x 0.742	VDDA x 0.272
1Dh	VDDA x 0.740	VDDA x 0.276
1Eh	VDDA x 0.737	VDDA x 0.279
1Fh	VDDA x 0.735	VDDA x 0.282
20h	VDDA x 0.733	VDDA x 0.285
21h	VDDA x 0.731	VDDA x 0.288
22h	VDDA x 0.729	VDDA x 0.291
23h	VDDA x 0.728	VDDA x 0.294
24h	VDDA x 0.726	VDDA x 0.297
25h	VDDA x 0.724	VDDA x 0.300
26h	VDDA x 0.721	VDDA x 0.302
27h	VDDA x 0.719	VDDA x 0.305
28h	VDDA x 0.717	VDDA x 0.308
29h	VDDA x 0.716	VDDA x 0.311
2Ah	VDDA x 0.714	VDDA x 0.315
2Bh	VDDA x 0.713	VDDA x 0.318
2Ch	VDDA x 0.712	VDDA x 0.321
2Dh	VDDA x 0.710	VDDA x 0.325
2Eh	VDDA x 0.708	VDDA x 0.328
2Fh	VDDA x 0.707	VDDA x 0.331
30h	VDDA x 0.704	VDDA x 0.334
31h	VDDA x 0.702	VDDA x 0.337
32h	VDDA x 0.700	VDDA x 0.340
33h	VDDA x 0.698	VDDA x 0.344
34h	VDDA x 0.697	VDDA x 0.349
35h	VDDA x 0.695	VDDA x 0.353
36h	VDDA x 0.693	VDDA x 0.358
37h	VDDA x 0.692	VDDA x 0.363
38h	VDDA x 0.690	VDDA x 0.368
39h	VDDA x 0.688	VDDA x 0.374
3Ah	VDDA x 0.686	VDDA x 0.381
3Bh	VDDA x 0.683	VDDA x 0.389
3Ch	VDDA x 0.680	VDDA x 0.398
3Dh	VDDA x 0.675	VDDA x 0.408
3Eh	VDDA x 0.664	VDDA x 0.423
3Fh	VDDA x 0.604	VDDA x 0.489

VDDA=10.4V		
V _{GMA}	Code	Voltage
V1	00h	9.99 V
V2	01h	9.74 V
V3	10h	8.06 V
V4	20h	7.62 V
V5	30h	7.32 V
V6	3Eh	6.91 V
V7	3Fh	6.28 V
V8	3Fh	5.09 V
V9	3Eh	4.40 V
V10	30h	3.47 V
V11	20h	2.96 V
V12	10h	2.36 V
V13	01h	0.47 V
V14	00h	0.198 V

5.8. Power ON/OFF Sequence

To prevent the device damage from latch up, the power ON/OFF sequence shown below must be followed.

Power ON: VDD, DGND → VDDA, AGND → V1 to V14

Power OFF: V1 to V14 → VDDA, AGND → VDD, DGND

In order to prevent ILI6122 from power ON reset fail, the rising time (t_{POR}) of the digital power supply VDD should be maintained within given specifications. The power ON/OFF timing sequence is illustrated as below:

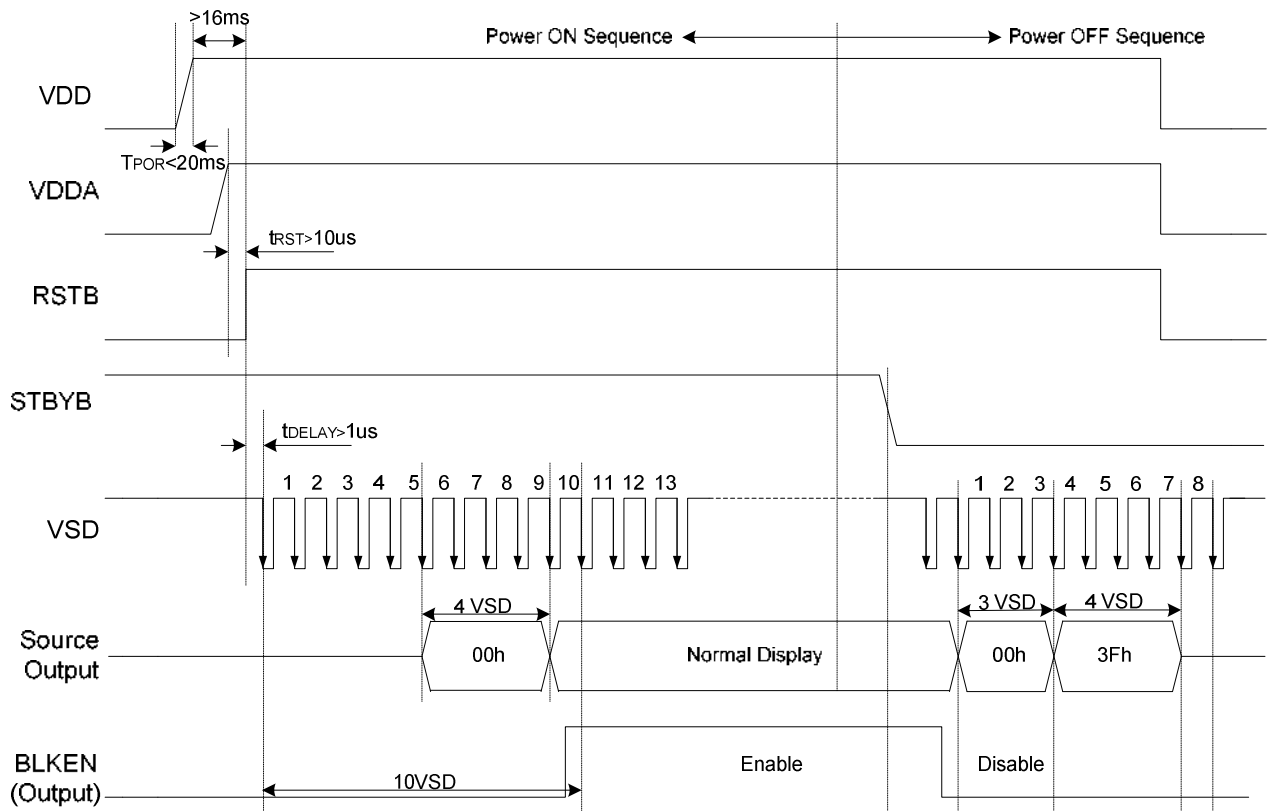

Note: For prevent anormal operation, t_{RST} must be longer than 10us during Power ON sequence.





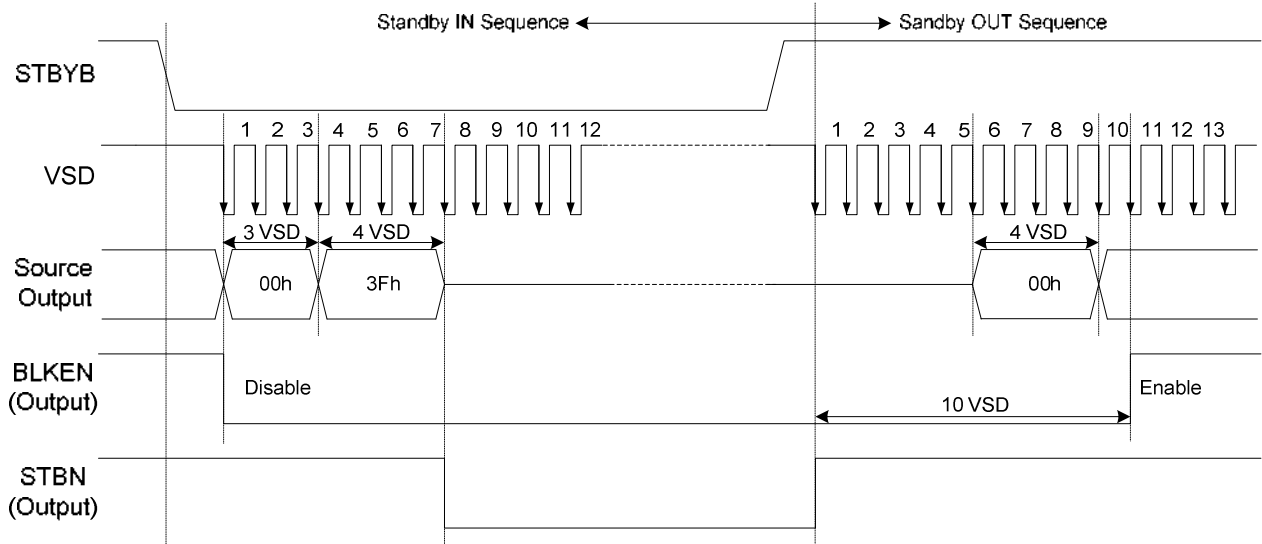



5.9. Standby ON/OFF Control

ILI6122 supports Standby mode for saving power consumption, the source driver will turn off and all source output channel will be Hi-Z state when chip in Standby mode. The Standby mode can be controlled via STBYB pin and the Standby ON/OFF timing sequence is illustrated as below:

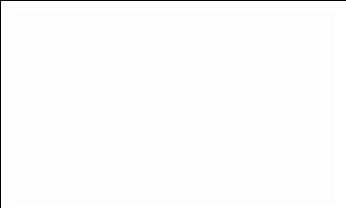
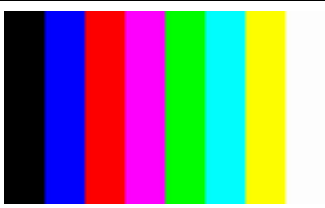
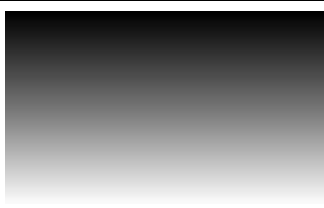
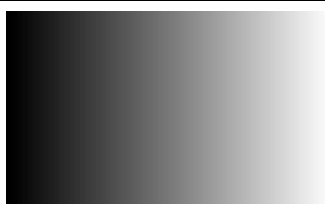

5.10. The BIST Patterns for Aging Mode Test

ILI6122 supports the function to generate BIST patterns for Aging mode test automatically. When external BIST pin goes “H” level, then ILI6122 will leave Normal operation mode and starts to generate the BIST patterns to LCD panel without external clock signal, The BIST patterns is illustrated as below:

1	2	3	4
Red	Green	Blue	Black
			
5	6	7	8
White	Vertical 8-color stripe	Horizontal 64-gray scale	Vertical 64-gray scale
			
9	10	11	12
Gray with black block	Gray with black dot	Gray with black line	Black with white frame
			

5.11. The Command Format for 3-line Serial Interface

ILI6122 using the 3-line serial port as communication interface for all the commands and parameters of CABC function. This 3-line serial communication can be bi-directional controlled by the “R/W” bit in address field. Under read mode, the 3-line engine in ILI6122 will return the data during “Data phase”. The returned data should be latched at the rising edge of SPCK by external controller. Data in the “Hi-Z phase” will be ignored by 3-line engine during write operation, and should be ignored during read operation also. During read operation, external controller should float SPDA pin under “Hi-Z phase” and “Data phase”.

Each Read/Write operation should be exactly 17 bit. To prevent from incorrect setting of the internal register, any write operation with more or less than 17 bit data during a CSX Low period will be ignored by 3-line engine.

The timing diagram of read/write operation is illustrated as below:

Write Operation

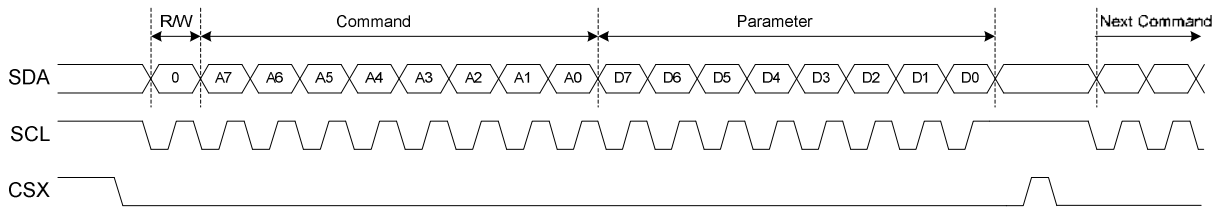

Read Operation

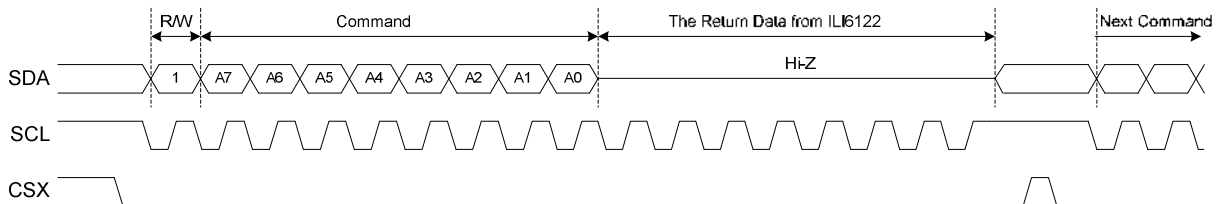

5.12. Command List

Command Function	D/C	R/W	D7	D6	D5	D4	D3	D2	D1	D0	Hex
Write Display Brightness Value	0	0	0	1	0	1	0	0	0	1	51h
	1	0	DBV[7:0]								
Read Display Brightness Value	0	0	0	1	0	1	1	0	0	0	52h
	1	1	DBV[7:0]								
Write CTRL Display	0	0	0	1	0	1	0	0	1	1	53h
	1	0	0	0	BCTRL	0	DD	BL	0	0	XX
Read CTRL Display	0	0	0	1	0	1	0	1	0	0	54h
	1	1	0	0	BCTRL	0	DD	BL	0	0	XX
Write Content Adaptive Brightness Control	0	0	1	0	0	0	0	0	1	0	82h
	1	0	0	0	C[1:0]	0	0	0	0	0	XX
Read Content Adaptive Brightness Control	0	0	1	0	0	0	0	0	1	0	82h
	1	1	0	0	C[1:0]	0	0	0	0	0	XX
Write CABC Minimum Brightness	0	0	0	1	0	1	1	1	1	0	5Eh
	1	0	CMB[7:0]								
Read CABC Minimum Brightness	0	0	0	1	0	1	1	1	1	1	5Fh
	1	1	CMB[7:0]								
CABC Control 1	0	0	0	1	1	0	0	0	0	0	60h
	1	0	PWM_DIV[7:0]								
CABC Control 2	0	0	0	1	1	0	0	0	0	1	61h
	1	0	THRES_MOV[3:0]			THRES_STILL[3:0]					
CABC Control 3	0	0	0	1	1	0	0	0	1	0	62h
	1	0	0	0	0	0	THRES_UI[3:0]				XX
CABC Control 4	0	0	0	1	1	0	0	0	1	1	63h
	1	0	DTH_MOV[3:0]			DTH_STILL[3:0]					
CABC Control 5	0	0	0	1	1	0	0	1	0	0	64h
	1	0	0	0	0	0	DTH_UI[3:0]				XX
CABC Control 6	0	0	0	1	1	0	0	1	0	1	65h
	1	0	DIM_OPT2[3:0]			DIM_OPT1[2:0]					

Register Default Value Table

Command Function	Address	Default
Display Brightness Value	52h	FFh
CTRL Display	54h	2Ch
Content Adaptive Brightness Control	82h	20h
CABC Minimum Brightness	5Fh	00h
CABC Control 1	60h	12h
CABC Control 2	61h	B8h
CABC Control 3	62h	04h
CABC Control 4	63h	C9h
CABC Control 5	64h	04h
CABC Control 6	65h	73h

Note : 1. These commands above can be transmitted from host to driver IC via 3-line SPI mode only.

2. When D/C in the table above is '0', it means the data on SDA/DBCM[1] pin is treated as "Command" and the data is treated as "Parameter" when D/C is set to '1'.

3. When R/W in the table above is '0', it means the "Write" operation is executed and the "Read" operation is executed when R/W is set to '1'

5.13. Command Description

5.13.1. Write Display Brightness Value (51h)

51h	WRDISBV (Write Display Brightness)								
	D7	D6	D5	D4	D3	D2	D1	D0	HEX
Command	0	1	0	1	0	0	0	1	51h
Parameter	DBV[7:0]								XX
Description	<p>This command is used to adjust the brightness value of the display.</p> <p>DBV[7:0]: 8 bit, for display brightness of manual brightness setting and CABC in ILI6122. There is a PWM output signal, BLKEN pin, to control the LED driver IC in order to control display brightness.</p>								

5.13.2. Read Display Brightness Value (52h)

52h	RDISBV (Read Display Brightness Value)								
	D7	D6	D5	D4	D3	D2	D1	D0	HEX
Command	0	1	0	1	0	0	1	0	52h
Parameter	DBV[7:0]								XX
Default	1	1	1	1	1	1	1	1	FFh
Description	<p>This command is used to return the brightness value of the display.</p> <p>DBV[7:0] is '0' when bit BCTRL of "Write CTRL Display Value (53h)" command is '0'.</p> <p>DBV[7:0] is manual set brightness specified with "Write CTRL Display Value (53h)" command when BCTRL bit is '1'.</p> <p>When bit BCTRL of "Write CTRL Display Value (53h)" command is '1' and C1/C0 bit of "Write Content Adaptive Brightness Control Value (55h)" command are '0', DBV[7:0] output is the brightness value specified with "Write Display Brightness Value (51h)" command.</p>								

5.13.3. Write CTRL Display Value (53h)

53h	WRCTRLD (Write Control Display)																				
	D7	D6	D5	D4	D3	D2	D1	D0	HEX												
Command	0	1	0	1	0	0	1	1	53h												
Parameter	X	X	BCTRL	X	DD	BL	X	X	XX												
Description	<p>This command is used to control display brightness.</p> <p>BCTRL: Brightness Control Block On/Off, This bit is always used to switch brightness for display.</p> <table border="1" style="margin-left: 40px;"> <thead> <tr> <th>BCTRL</th> <th>Description</th> </tr> </thead> <tbody> <tr> <td>0</td> <td>Brightness Control Block OFF (DBV[7:0]=00h)</td> </tr> <tr> <td>1</td> <td>Brightness Control Block ON (DBV[7:0] is active)</td> </tr> </tbody> </table> <p>DD: Display Dimming Control. This function is only for manual brightness setting.</p> <table border="1" style="margin-left: 40px;"> <thead> <tr> <th>DD</th> <th>Description</th> </tr> </thead> <tbody> <tr> <td>0</td> <td>Display Dimming OFF</td> </tr> <tr> <td>1</td> <td>Display Dimming ON</td> </tr> </tbody> </table>									BCTRL	Description	0	Brightness Control Block OFF (DBV[7:0]=00h)	1	Brightness Control Block ON (DBV[7:0] is active)	DD	Description	0	Display Dimming OFF	1	Display Dimming ON
BCTRL	Description																				
0	Brightness Control Block OFF (DBV[7:0]=00h)																				
1	Brightness Control Block ON (DBV[7:0] is active)																				
DD	Description																				
0	Display Dimming OFF																				
1	Display Dimming ON																				

	<p>BL: Backlight Control On/Off</p> <table border="1" style="margin-left: auto; margin-right: auto;"> <thead> <tr> <th>BL</th> <th>Description</th> </tr> </thead> <tbody> <tr> <td>0</td> <td>Backlight Control OFF</td> </tr> <tr> <td>1</td> <td>Backlight Control ON</td> </tr> </tbody> </table> <p>Dimming function is adapted to the brightness registers for display when bit BCTRL is changed at DD=1, e.g. BCTRL: 0 -> 1 or 1-> 0.</p> <p>When BL bit change from "On" to "Off", backlight is turned off without gradual dimming, even if dimming-on (DD=1) are selected.</p> <p>X = Don't care</p>	BL	Description	0	Backlight Control OFF	1	Backlight Control ON
BL	Description						
0	Backlight Control OFF						
1	Backlight Control ON						

5.13.4. Read CTRL Display Value (54h)

54h	RDCTRLD (Read Control Display Value)														
	D7	D6	D5	D4	D3	D2	D1	D0	HEX						
Command	0	1	0	1	0	1	0	0	54h						
Parameter	X	X	BCTRL	X	DD	BL	X	X	XX						
Default	0	0	1	0	1	1	0	0	2Ch						
Description	This command is used to control display brightness.														
	BCTRL: Brightness Control Block On/Off, This bit is always used to switch brightness for display.														
	<table border="1" style="margin-left: auto; margin-right: auto;"> <thead> <tr> <th>BCTRL</th> <th>Description</th> </tr> </thead> <tbody> <tr> <td>0</td> <td>Brightness Control Block OFF (DBV[7:0]=00h)</td> </tr> <tr> <td>1</td> <td>Brightness Control Block ON (DBV[7:0] is active)</td> </tr> </tbody> </table>									BCTRL	Description	0	Brightness Control Block OFF (DBV[7:0]=00h)	1	Brightness Control Block ON (DBV[7:0] is active)
	BCTRL	Description													
	0	Brightness Control Block OFF (DBV[7:0]=00h)													
1	Brightness Control Block ON (DBV[7:0] is active)														
DD: Display Dimming Control. This function is only for manual brightness setting.															
<table border="1" style="margin-left: auto; margin-right: auto;"> <thead> <tr> <th>DD</th> <th>Description</th> </tr> </thead> <tbody> <tr> <td>0</td> <td>Display Dimming OFF</td> </tr> <tr> <td>1</td> <td>Display Dimming ON</td> </tr> </tbody> </table>									DD	Description	0	Display Dimming OFF	1	Display Dimming ON	
DD	Description														
0	Display Dimming OFF														
1	Display Dimming ON														
BL: Backlight Control On/Off															
<table border="1" style="margin-left: auto; margin-right: auto;"> <thead> <tr> <th>BL</th> <th>Description</th> </tr> </thead> <tbody> <tr> <td>0</td> <td>Backlight Control OFF</td> </tr> <tr> <td>1</td> <td>Backlight Control ON</td> </tr> </tbody> </table>									BL	Description	0	Backlight Control OFF	1	Backlight Control ON	
BL	Description														
0	Backlight Control OFF														
1	Backlight Control ON														
X = Don't care															

5.13.5. Write Content Adaptive Brightness Control Value (82h)

55h	WRCABC (Write Content Adaptive Brightness Control)																		
	D7	D6	D5	D4	D3	D2	D1	D0	HEX										
Command	1	0	0	0	0	0	1	0	82h										
Parameter	X	X	C[1:0]		X	X	0	0	XX										
Description	This command is used to set parameters for image content based adaptive brightness control functionality.																		
	There is possible to use 4 different modes for content adaptive image functionality, which are defined on a table below.																		
	<table border="1" style="margin-left: auto; margin-right: auto;"> <thead> <tr> <th>C[1:0]</th> <th>Description</th> </tr> </thead> <tbody> <tr> <td>0 0</td> <td>CABC OFF</td> </tr> <tr> <td>0 1</td> <td>User Interface Image</td> </tr> <tr> <td>1 0</td> <td>Still Picture</td> </tr> <tr> <td>1 1</td> <td>Moving Image</td> </tr> </tbody> </table>									C[1:0]	Description	0 0	CABC OFF	0 1	User Interface Image	1 0	Still Picture	1 1	Moving Image
	C[1:0]	Description																	
	0 0	CABC OFF																	
0 1	User Interface Image																		
1 0	Still Picture																		
1 1	Moving Image																		
X = Don't care																			

5.13.6. Read Content Adaptive Brightness Control Value (82h)

56h				RDCABC (Read Content Adaptive Brightness Control)														
	D7	D6	D5	D4	D3	D2	D1	D0	HEX									
Command	1	0	0	0	0	0	1	0	82h									
Parameter	X	X	C[1:0]		X	X	0	0	XX									
Default	0	0	1	0	0	0	0	0	20h									
Description	This command is used to read the settings for image content based adaptive brightness control functionality. There is possible to use 4 different modes for content adaptive image functionality which are defined on the table below.																	
	<table border="1"> <thead> <tr> <th>C[1:0]</th> <th>Description</th> </tr> </thead> <tbody> <tr> <td>0 0</td> <td>CABC OFF</td> </tr> <tr> <td>0 1</td> <td>User Interface Image</td> </tr> <tr> <td>1 0</td> <td>Still Picture</td> </tr> <tr> <td>1 1</td> <td>Moving Image</td> </tr> </tbody> </table>									C[1:0]	Description	0 0	CABC OFF	0 1	User Interface Image	1 0	Still Picture	1 1
C[1:0]	Description																	
0 0	CABC OFF																	
0 1	User Interface Image																	
1 0	Still Picture																	
1 1	Moving Image																	
X = Don't care																		

5.13.7. Write CABC Minimum Brightness (5Eh)

5Eh	WRCABCMB (Write CABC Minimum Brightness)								
	D7	D6	D5	D4	D3	D2	D1	D0	HEX
Command	0	1	0	1	1	1	1	0	5Eh
Parameter	CMB[7:0]								XX
Description	This command is used to set the minimum brightness value of the display for CABC function.								
	<p>CMB[7:0]: CABC minimum brightness control, this parameter is used to avoid too much brightness reduction.</p> <p>When CABC is active, CABC can not reduce the display brightness to less than CABC minimum brightness setting. Image processing function is worked as normal, even if the brightness can not be changed.</p> <p>This function does not affect to the other function, manual brightness setting. Manual brightness can be set the display brightness to less than CABC minimum brightness. Smooth transition and dimming function can be worked as normal.</p> <p>When display brightness is turned off (BCTRL=0 of "Write CTRL Display (53h)"), CABC minimum brightness setting is ignored.</p> <p>In principle relationship is that 00h value means the lowest brightness for CABC and FFh value means the highest brightness for CABC.</p>								

5.13.8. Read CABC Minimum Brightness (5Fh)

5Fh	RDCABCMB (Read CABC Minimum Brightness)								
	D7	D6	D5	D4	D3	D2	D1	D0	HEX
Command	0	1	0	1	1	1	1	1	5Fh
Parameter	CMB[7:0]								XX
Default	0	0	0	0	0	0	0	0	00h
Description	This command returns the minimum brightness value of CABC function.								
	<p>In principle the relationship is that 00h value means the lowest brightness and FFh value means the highest brightness.</p> <p>CMB[7:0] is CABC minimum brightness specified with "Write CABC minimum brightness (5Eh)" command.</p>								

5.13.9. CABC Control 1 (60h)

60h	CABCCTRL1 (CABC Control 1)								HEX																																																																																																																																							
	D7	D6	D5	D4	D3	D2	D1	D0																																																																																																																																								
Command	0	1	1	0	0	0	0	0	60h																																																																																																																																							
Parameter	PWM_DIV[7:0]								XX																																																																																																																																							
Default	0	0	0	1	0	0	1	0	12h																																																																																																																																							
Description	<p>PWM_DIV[7:0]: BLKEN output period control. This command is used to adjust the PWM waveform period of BLKEN. The PWM period can be calculated using the equation in the following.</p> $f_{BLKEN} = \frac{6MHz}{(PWM_DIV[7:0]+1) \times 255}$ <table border="1" style="margin-left: auto; margin-right: auto;"> <thead> <tr> <th colspan="8">PWM_DIV[7:0]</th> <th>F_{BLKEN}</th> </tr> <tr> <th>D7</th> <th>D6</th> <th>D5</th> <th>D4</th> <th>D3</th> <th>D2</th> <th>D1</th> <th>D0</th> <th></th> </tr> </thead> <tbody> <tr> <td>0</td><td>0</td><td>0</td><td>0</td><td>0</td><td>0</td><td>0</td><td>0</td> <td>25.53KHz</td> </tr> <tr> <td>0</td><td>0</td><td>0</td><td>0</td><td>0</td><td>0</td><td>0</td><td>1</td> <td>11.76KHz</td> </tr> <tr> <td>0</td><td>0</td><td>0</td><td>0</td><td>0</td><td>0</td><td>1</td><td>0</td> <td>7.84KHz</td> </tr> <tr> <td>0</td><td>0</td><td>0</td><td>0</td><td>0</td><td>0</td><td>1</td><td>1</td> <td>5.88KHz</td> </tr> <tr> <td>0</td><td>0</td><td>0</td><td>0</td><td>0</td><td>1</td><td>0</td><td>0</td> <td>4.71KHz</td> </tr> <tr> <td colspan="8" style="text-align: center;">⋮</td> <td></td> </tr> <tr> <td>0</td><td>0</td><td>0</td><td>1</td><td>0</td><td>0</td><td>1</td><td>0</td> <td>1.24KHz</td> </tr> <tr> <td colspan="8" style="text-align: center;">⋮</td> <td></td> </tr> <tr> <td>1</td><td>1</td><td>1</td><td>1</td><td>1</td><td>0</td><td>1</td><td>1</td> <td>93.37</td> </tr> <tr> <td>1</td><td>1</td><td>1</td><td>1</td><td>1</td><td>1</td><td>0</td><td>0</td> <td>93.00</td> </tr> <tr> <td>1</td><td>1</td><td>1</td><td>1</td><td>1</td><td>1</td><td>0</td><td>1</td> <td>92.64</td> </tr> <tr> <td>1</td><td>1</td><td>1</td><td>1</td><td>1</td><td>1</td><td>1</td><td>0</td> <td>92.27</td> </tr> <tr> <td>1</td><td>1</td><td>1</td><td>1</td><td>1</td><td>1</td><td>1</td><td>1</td> <td>91.91</td> </tr> </tbody> </table>									PWM_DIV[7:0]								F _{BLKEN}	D7	D6	D5	D4	D3	D2	D1	D0		0	0	0	0	0	0	0	0	25.53KHz	0	0	0	0	0	0	0	1	11.76KHz	0	0	0	0	0	0	1	0	7.84KHz	0	0	0	0	0	0	1	1	5.88KHz	0	0	0	0	0	1	0	0	4.71KHz	⋮									0	0	0	1	0	0	1	0	1.24KHz	⋮									1	1	1	1	1	0	1	1	93.37	1	1	1	1	1	1	0	0	93.00	1	1	1	1	1	1	0	1	92.64	1	1	1	1	1	1	1	0	92.27	1	1	1	1	1	1	1	1	91.91
	PWM_DIV[7:0]								F _{BLKEN}																																																																																																																																							
	D7	D6	D5	D4	D3	D2	D1	D0																																																																																																																																								
	0	0	0	0	0	0	0	0	25.53KHz																																																																																																																																							
	0	0	0	0	0	0	0	1	11.76KHz																																																																																																																																							
	0	0	0	0	0	0	1	0	7.84KHz																																																																																																																																							
	0	0	0	0	0	0	1	1	5.88KHz																																																																																																																																							
	0	0	0	0	0	1	0	0	4.71KHz																																																																																																																																							
	⋮																																																																																																																																															
	0	0	0	1	0	0	1	0	1.24KHz																																																																																																																																							
	⋮																																																																																																																																															
	1	1	1	1	1	0	1	1	93.37																																																																																																																																							
	1	1	1	1	1	1	0	0	93.00																																																																																																																																							
	1	1	1	1	1	1	0	1	92.64																																																																																																																																							
	1	1	1	1	1	1	1	0	92.27																																																																																																																																							
1	1	1	1	1	1	1	1	91.91																																																																																																																																								
<p>Note : The output frequency tolerance of internal frequency divider in BLKEN pin is ±10%</p>																																																																																																																																																

5.13.10. CABC Control 2 (61h)

61h	CABCCTRL2 (CABC Control 2)								HEX
	D7	D6	D5	D4	D3	D2	D1	D0	
Command	0	1	1	0	0	0	0	1	61h
Parameter	THRES_MOV[3:0]				THRES_STILL[3:0]				XX
Default	1	0	1	1	1	0	0	0	B8h

THRES_MOV[3:0]: This parameter is used to set the ratio (percentage) of the maximum number of pixels that makes display image white (data="63") to the total of pixels by image process in MOVING image mode. After this parameter sets the number of pixels that makes display image white, threshold grayscale value (DTH) that makes display image white is set so that the number of the pixels set by this parameter does not change.

THRES_MOV[3:0]				Description	THRES_MOV[3:0]				Description
D3	D2	D1	D0		D3	D2	D1	D0	
0	0	0	0	99 %	1	0	0	0	84 %
0	0	0	1	98 %	1	0	0	1	82 %
0	0	1	0	96 %	1	0	1	0	80 %
0	0	1	1	94 %	1	0	1	1	78 %
0	1	0	0	92 %	1	1	0	0	76 %
0	1	0	1	90 %	1	1	0	1	74 %
0	1	1	0	88 %	1	1	1	0	72 %
0	1	1	1	86 %	1	1	1	1	70 %

THRES_STILL[3:0]: This parameter is used to set the ratio (percentage) of the maximum number of pixels that makes display image white (data="63") to the total of pixels by image process in STILL mode. After this parameter sets the number of pixels that makes display image white, threshold grayscale value (DTH) that makes display image white is set so that the number of the pixels set by this parameter does not change.

Description

THRES_STILL[3:0]				Description	THRES_STILL[3:0]				Description
D3	D2	D1	D0		D3	D2	D1	D0	
0	0	0	0	99 %	1	0	0	0	84 %
0	0	0	1	98 %	1	0	0	1	82 %
0	0	1	0	96 %	1	0	1	0	80 %
0	0	1	1	94 %	1	0	1	1	78 %
0	1	0	0	92 %	1	1	0	0	76 %
0	1	0	1	90 %	1	1	0	1	74 %
0	1	1	0	88 %	1	1	1	0	72 %
0	1	1	1	86 %	1	1	1	1	70 %

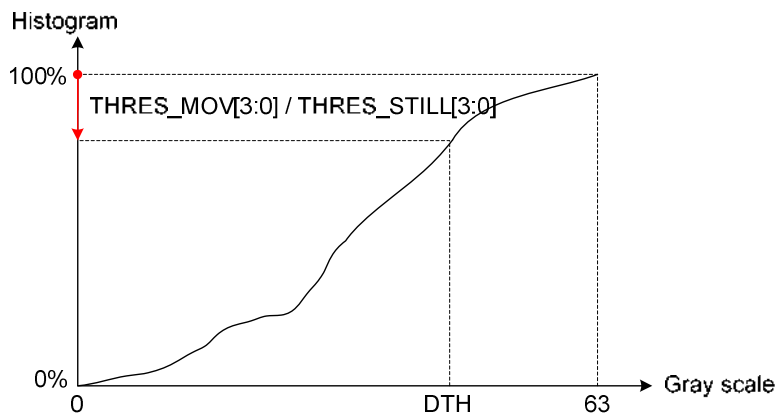

5.13.11. CABC Control 3 (62h)

62h	CABCCTRL3 (CABC Control 3)								HEX																																																																																																	
	D7	D6	D5	D4	D3	D2	D1	D0																																																																																																		
Command	0	1	1	0	0	0	1	0	62h																																																																																																	
Parameter	0	0	0	0	THRES_UI[3:0]				XX																																																																																																	
Default	0	0	0	0	0	1	0	0	04h																																																																																																	
Description	<p>THRES_UI[3:0]: This parameter is used to set the ratio (percentage) of the maximum number of pixels that makes display image white (data="63) to the total of pixels by image process in USER INTERFACE mode. After this parameter sets the number of pixels that makes display image white, threshold grayscale value (DTH) that makes display image white is set so that the number of the pixels set by this parameter does not change.</p>																																																																																																									
	<table border="1"> <thead> <tr> <th colspan="4">THRES_UI[3:0]</th> <th rowspan="2">Description</th> </tr> <tr> <th>D3</th> <th>D2</th> <th>D1</th> <th>D0</th> </tr> </thead> <tbody> <tr><td>0</td><td>0</td><td>0</td><td>0</td><td>99 %</td></tr> <tr><td>0</td><td>0</td><td>0</td><td>1</td><td>98 %</td></tr> <tr><td>0</td><td>0</td><td>1</td><td>0</td><td>96 %</td></tr> <tr><td>0</td><td>0</td><td>1</td><td>1</td><td>94 %</td></tr> <tr><td>0</td><td>1</td><td>0</td><td>0</td><td>92 %</td></tr> <tr><td>0</td><td>1</td><td>0</td><td>1</td><td>90 %</td></tr> <tr><td>0</td><td>1</td><td>1</td><td>0</td><td>88 %</td></tr> <tr><td>0</td><td>1</td><td>1</td><td>1</td><td>86 %</td></tr> </tbody> </table>					THRES_UI[3:0]				Description	D3	D2	D1	D0	0	0	0	0	99 %	0	0	0	1	98 %	0	0	1	0	96 %	0	0	1	1	94 %	0	1	0	0	92 %	0	1	0	1	90 %	0	1	1	0	88 %	0	1	1	1	86 %	<table border="1"> <thead> <tr> <th colspan="4">THRES_UI[3:0]</th> <th rowspan="2">Description</th> </tr> <tr> <th>D3</th> <th>D2</th> <th>D1</th> <th>D0</th> </tr> </thead> <tbody> <tr><td>1</td><td>0</td><td>0</td><td>0</td><td>84 %</td></tr> <tr><td>1</td><td>0</td><td>0</td><td>1</td><td>82 %</td></tr> <tr><td>1</td><td>0</td><td>1</td><td>0</td><td>80 %</td></tr> <tr><td>1</td><td>0</td><td>1</td><td>1</td><td>78 %</td></tr> <tr><td>1</td><td>1</td><td>0</td><td>0</td><td>76 %</td></tr> <tr><td>1</td><td>1</td><td>0</td><td>1</td><td>74 %</td></tr> <tr><td>1</td><td>1</td><td>1</td><td>0</td><td>72 %</td></tr> <tr><td>1</td><td>1</td><td>1</td><td>1</td><td>70 %</td></tr> </tbody> </table>				THRES_UI[3:0]				Description	D3	D2	D1	D0	1	0	0	0	84 %	1	0	0	1	82 %	1	0	1	0	80 %	1	0	1	1	78 %	1	1	0	0	76 %	1	1	0	1	74 %	1	1	1	0	72 %	1	1	1	1
THRES_UI[3:0]				Description																																																																																																						
D3	D2	D1	D0																																																																																																							
0	0	0	0	99 %																																																																																																						
0	0	0	1	98 %																																																																																																						
0	0	1	0	96 %																																																																																																						
0	0	1	1	94 %																																																																																																						
0	1	0	0	92 %																																																																																																						
0	1	0	1	90 %																																																																																																						
0	1	1	0	88 %																																																																																																						
0	1	1	1	86 %																																																																																																						
THRES_UI[3:0]				Description																																																																																																						
D3	D2	D1	D0																																																																																																							
1	0	0	0	84 %																																																																																																						
1	0	0	1	82 %																																																																																																						
1	0	1	0	80 %																																																																																																						
1	0	1	1	78 %																																																																																																						
1	1	0	0	76 %																																																																																																						
1	1	0	1	74 %																																																																																																						
1	1	1	0	72 %																																																																																																						
1	1	1	1	70 %																																																																																																						
<p>Histogram</p> <p>100% THRES_UI[3:0]</p> <p>0% 0 DTH 63 Gray scale</p>																																																																																																										

5.13.12. CABControl 4 (63h)

63h	CABCCTRL4 (CABC Control 4)								HEX																																																																																																		
	D7	D6	D5	D4	D3	D2	D1	D0																																																																																																			
Command	0	1	1	0	0	0	1	1	63h																																																																																																		
Parameter	DTH_MOV[3:0]				DTH_STILL[3:0]				XX																																																																																																		
Default	1	1	0	0	1	0	0	1	C9h																																																																																																		
Description	<p>DTH_MOV[3:0]: This parameter is used set the minimum limitation of grayscale threshold value in MOVING image mode.</p> <table border="1"> <thead> <tr> <th colspan="4">DTH_MOV[3:0]</th> <th rowspan="2">Description</th> <th colspan="4">DTH_MOV[3:0]</th> <th rowspan="2">Description</th> </tr> <tr> <th>D3</th> <th>D2</th> <th>D1</th> <th>D0</th> <th>D3</th> <th>D2</th> <th>D1</th> <th>D0</th> </tr> </thead> <tbody> <tr><td>0</td><td>0</td><td>0</td><td>0</td><td>224</td><td>1</td><td>0</td><td>0</td><td>0</td><td>192</td></tr> <tr><td>0</td><td>0</td><td>0</td><td>1</td><td>220</td><td>1</td><td>0</td><td>0</td><td>1</td><td>188</td></tr> <tr><td>0</td><td>0</td><td>1</td><td>0</td><td>216</td><td>1</td><td>0</td><td>1</td><td>0</td><td>184</td></tr> <tr><td>0</td><td>0</td><td>1</td><td>1</td><td>212</td><td>1</td><td>0</td><td>1</td><td>1</td><td>180</td></tr> <tr><td>0</td><td>1</td><td>0</td><td>0</td><td>208</td><td>1</td><td>1</td><td>0</td><td>0</td><td>176</td></tr> <tr><td>0</td><td>1</td><td>0</td><td>1</td><td>204</td><td>1</td><td>1</td><td>0</td><td>1</td><td>172</td></tr> <tr><td>0</td><td>1</td><td>1</td><td>0</td><td>200</td><td>1</td><td>1</td><td>1</td><td>0</td><td>168</td></tr> <tr><td>0</td><td>1</td><td>1</td><td>1</td><td>196</td><td>1</td><td>1</td><td>1</td><td>1</td><td>164</td></tr> </tbody> </table>									DTH_MOV[3:0]				Description	DTH_MOV[3:0]				Description	D3	D2	D1	D0	D3	D2	D1	D0	0	0	0	0	224	1	0	0	0	192	0	0	0	1	220	1	0	0	1	188	0	0	1	0	216	1	0	1	0	184	0	0	1	1	212	1	0	1	1	180	0	1	0	0	208	1	1	0	0	176	0	1	0	1	204	1	1	0	1	172	0	1	1	0	200	1	1	1	0	168	0	1	1	1	196	1	1	1	1	164
	DTH_MOV[3:0]				Description	DTH_MOV[3:0]				Description																																																																																																	
	D3	D2	D1	D0		D3	D2	D1	D0																																																																																																		
	0	0	0	0	224	1	0	0	0	192																																																																																																	
	0	0	0	1	220	1	0	0	1	188																																																																																																	
	0	0	1	0	216	1	0	1	0	184																																																																																																	
	0	0	1	1	212	1	0	1	1	180																																																																																																	
	0	1	0	0	208	1	1	0	0	176																																																																																																	
	0	1	0	1	204	1	1	0	1	172																																																																																																	
	0	1	1	0	200	1	1	1	0	168																																																																																																	
0	1	1	1	196	1	1	1	1	164																																																																																																		
<p>DTH_OPT[2:0]: This parameter is used to set the minimum limitation of grayscale threshold value in STILL image mode.</p> <table border="1"> <thead> <tr> <th colspan="4">DTH_STILL[3:0]</th> <th rowspan="2">Description</th> <th colspan="4">DTH_STILL[3:0]</th> <th rowspan="2">Description</th> </tr> <tr> <th>D3</th> <th>D2</th> <th>D1</th> <th>D0</th> <th>D3</th> <th>D2</th> <th>D1</th> <th>D0</th> </tr> </thead> <tbody> <tr><td>0</td><td>0</td><td>0</td><td>0</td><td>224</td><td>1</td><td>0</td><td>0</td><td>0</td><td>192</td></tr> <tr><td>0</td><td>0</td><td>0</td><td>1</td><td>220</td><td>1</td><td>0</td><td>0</td><td>1</td><td>188</td></tr> <tr><td>0</td><td>0</td><td>1</td><td>0</td><td>216</td><td>1</td><td>0</td><td>1</td><td>0</td><td>184</td></tr> <tr><td>0</td><td>0</td><td>1</td><td>1</td><td>212</td><td>1</td><td>0</td><td>1</td><td>1</td><td>180</td></tr> <tr><td>0</td><td>1</td><td>0</td><td>0</td><td>208</td><td>1</td><td>1</td><td>0</td><td>0</td><td>176</td></tr> <tr><td>0</td><td>1</td><td>0</td><td>1</td><td>204</td><td>1</td><td>1</td><td>0</td><td>1</td><td>172</td></tr> <tr><td>0</td><td>1</td><td>1</td><td>0</td><td>200</td><td>1</td><td>1</td><td>1</td><td>0</td><td>168</td></tr> <tr><td>0</td><td>1</td><td>1</td><td>1</td><td>196</td><td>1</td><td>1</td><td>1</td><td>1</td><td>164</td></tr> </tbody> </table>									DTH_STILL[3:0]				Description	DTH_STILL[3:0]				Description	D3	D2	D1	D0	D3	D2	D1	D0	0	0	0	0	224	1	0	0	0	192	0	0	0	1	220	1	0	0	1	188	0	0	1	0	216	1	0	1	0	184	0	0	1	1	212	1	0	1	1	180	0	1	0	0	208	1	1	0	0	176	0	1	0	1	204	1	1	0	1	172	0	1	1	0	200	1	1	1	0	168	0	1	1	1	196	1	1	1	1	164	
DTH_STILL[3:0]				Description	DTH_STILL[3:0]				Description																																																																																																		
D3	D2	D1	D0		D3	D2	D1	D0																																																																																																			
0	0	0	0	224	1	0	0	0	192																																																																																																		
0	0	0	1	220	1	0	0	1	188																																																																																																		
0	0	1	0	216	1	0	1	0	184																																																																																																		
0	0	1	1	212	1	0	1	1	180																																																																																																		
0	1	0	0	208	1	1	0	0	176																																																																																																		
0	1	0	1	204	1	1	0	1	172																																																																																																		
0	1	1	0	200	1	1	1	0	168																																																																																																		
0	1	1	1	196	1	1	1	1	164																																																																																																		

5.13.13. CABC Control 5 (64h)

64h	CABCCTRL5 (CABC Control 5)								HEX																																																																																																		
	D7	D6	D5	D4	D3	D2	D1	D0																																																																																																			
Command	0	1	1	0	0	1	0	0	64h																																																																																																		
Parameter	DTH_UI[3:0]								XX																																																																																																		
Default	0	0	0	0	0	1	0	0	04h																																																																																																		
Description	<p>DTH_UI[3:0]: This parameter is used set the minimum limitation of grayscale threshold value in USER INTERFACE mode.</p> <table border="1"> <thead> <tr> <th colspan="4">DTH_UI[3:0]</th> <th rowspan="2">Description</th> <th colspan="4">DTH_UI[3:0]</th> <th rowspan="2">Description</th> </tr> <tr> <th>D3</th> <th>D2</th> <th>D1</th> <th>D0</th> <th>D3</th> <th>D2</th> <th>D1</th> <th>D0</th> </tr> </thead> <tbody> <tr> <td>0</td> <td>0</td> <td>0</td> <td>0</td> <td>252</td> <td>1</td> <td>0</td> <td>0</td> <td>0</td> <td>220</td> </tr> <tr> <td>0</td> <td>0</td> <td>0</td> <td>1</td> <td>248</td> <td>1</td> <td>0</td> <td>0</td> <td>1</td> <td>216</td> </tr> <tr> <td>0</td> <td>0</td> <td>1</td> <td>0</td> <td>244</td> <td>1</td> <td>0</td> <td>1</td> <td>0</td> <td>212</td> </tr> <tr> <td>0</td> <td>0</td> <td>1</td> <td>1</td> <td>240</td> <td>1</td> <td>0</td> <td>1</td> <td>1</td> <td>208</td> </tr> <tr> <td>0</td> <td>1</td> <td>0</td> <td>0</td> <td>236</td> <td>1</td> <td>1</td> <td>0</td> <td>0</td> <td>2-4</td> </tr> <tr> <td>0</td> <td>1</td> <td>0</td> <td>1</td> <td>232</td> <td>1</td> <td>1</td> <td>0</td> <td>1</td> <td>200</td> </tr> <tr> <td>0</td> <td>1</td> <td>1</td> <td>0</td> <td>228</td> <td>1</td> <td>1</td> <td>1</td> <td>0</td> <td>196</td> </tr> <tr> <td>0</td> <td>1</td> <td>1</td> <td>1</td> <td>224</td> <td>1</td> <td>1</td> <td>1</td> <td>1</td> <td>192</td> </tr> </tbody> </table>									DTH_UI[3:0]				Description	DTH_UI[3:0]				Description	D3	D2	D1	D0	D3	D2	D1	D0	0	0	0	0	252	1	0	0	0	220	0	0	0	1	248	1	0	0	1	216	0	0	1	0	244	1	0	1	0	212	0	0	1	1	240	1	0	1	1	208	0	1	0	0	236	1	1	0	0	2-4	0	1	0	1	232	1	1	0	1	200	0	1	1	0	228	1	1	1	0	196	0	1	1	1	224	1	1	1	1	192
	DTH_UI[3:0]				Description	DTH_UI[3:0]				Description																																																																																																	
	D3	D2	D1	D0		D3	D2	D1	D0																																																																																																		
	0	0	0	0	252	1	0	0	0	220																																																																																																	
	0	0	0	1	248	1	0	0	1	216																																																																																																	
	0	0	1	0	244	1	0	1	0	212																																																																																																	
	0	0	1	1	240	1	0	1	1	208																																																																																																	
	0	1	0	0	236	1	1	0	0	2-4																																																																																																	
	0	1	0	1	232	1	1	0	1	200																																																																																																	
	0	1	1	0	228	1	1	1	0	196																																																																																																	
0	1	1	1	224	1	1	1	1	192																																																																																																		

5.13.14. CABC Control 6 (65h)

65h	CABCCTRL6 (CABC Control 6)								HEX																																							
	D7	D6	D5	D4	D3	D2	D1	D0																																								
Command	0	1	1	0	0	1	0	1	65h																																							
Parameter	DIM_OPT2[3:0]				0	DIM_OPT1[2:0]			XX																																							
Default	0	1	1	1	0	0	1	1	73h																																							
Description	<p>DIM_OPT1[2:0]: This parameter is used set the transition time of brightness level change to avoid the sharp brightness change on vision.</p> <table border="1"> <thead> <tr> <th colspan="3">DIM_OPT1[2:0]</th> <th rowspan="2">Description</th> </tr> <tr> <th>D2</th> <th>D1</th> <th>D0</th> </tr> </thead> <tbody> <tr> <td>0</td> <td>0</td> <td>0</td> <td>1 frame</td> </tr> <tr> <td>0</td> <td>0</td> <td>1</td> <td>1 frame</td> </tr> <tr> <td>0</td> <td>1</td> <td>0</td> <td>2 frames</td> </tr> <tr> <td>0</td> <td>1</td> <td>1</td> <td>4 frames</td> </tr> <tr> <td>1</td> <td>0</td> <td>0</td> <td>8 frames</td> </tr> <tr> <td>1</td> <td>0</td> <td>1</td> <td>16 frames</td> </tr> <tr> <td>1</td> <td>1</td> <td>0</td> <td>32 frames</td> </tr> <tr> <td>1</td> <td>1</td> <td>1</td> <td>64 frames</td> </tr> </tbody> </table>									DIM_OPT1[2:0]			Description	D2	D1	D0	0	0	0	1 frame	0	0	1	1 frame	0	1	0	2 frames	0	1	1	4 frames	1	0	0	8 frames	1	0	1	16 frames	1	1	0	32 frames	1	1	1	64 frames
	DIM_OPT1[2:0]			Description																																												
	D2	D1	D0																																													
	0	0	0	1 frame																																												
	0	0	1	1 frame																																												
	0	1	0	2 frames																																												
	0	1	1	4 frames																																												
	1	0	0	8 frames																																												
	1	0	1	16 frames																																												
	1	1	0	32 frames																																												
1	1	1	64 frames																																													
<p>DIM_OPT2[3:0]: This parameter is used to set the imitation of minimum brightness change. If this parameter is large than the difference between target brightness and current brightness, then the brightness will not change.</p>																																																

6. DC Characteristic

6.1. Absolute Maximum Rating (DGND = AGND=0V, Ta=25°C)

Parameter	Symbol	Spec			Unit
		Min.	Typ.	Max.	
Power supply voltage 1	VDD	-0.5	--	+5.0	V
Power supply voltage 2	VDDA	-0.5	--	+13.5	V
Gamma correction voltage	V1 ~ V14	-0.5	--	+13.5	V
Input voltage	Vin	0	--	VDD+0.3	V
Operation temperature	TOPR	-20	--	+85	°C
Storage temperature	TSTG	-55	--	+125	°C

Note: (1) All of the voltages listed above are with respect to DGND=AGND=0V.

(2) Device is subject to be damaged permanently if stresses beyond those absolute maximum ratings listed above.

6.2. DC Electrical Characteristics (DGND=AGND=0V, Ta=25°C)

Parameter	Symbol	Spec			Unit	Conditions
		Min.	Typ.	Max.		
Power supply voltage	VDD	3.0	3.3	3.6	V	
Power supply voltage	VDDA	6.5	10.4	13.5	V	
Low level input voltage	V _{IL}	0	--	0.3VCC	V	For the digital circuit block
High level input voltage	V _{IH}	0.7VDD	--	VCC	V	For the digital circuit block
Output low voltage	V _{OL}	--	--	GND+0.4	V	IOL=+400μA
Output high voltage	V _{OH}	VDD-0.4	--	--	V	IOH=-400μA
Input leakage current	I _{IN}	--	--	±1	μA	No pull up or pull down.
Input level of V1~V7	V _{REF1}	0.4VDDA	--	VDDA-0.1	V	Gamma correction voltage input
Input level of V8~V14	V _{REF2}	0.1	--	0.6VDDA	V	Gamma correction voltage input
Output voltage deviation	V _{OD1}	--	±20	±35	mV	VO=AGND+0.1V ~ AGND+0.5V and VO=VDDA-0.1V ~ VDDA-0.5V
Output voltage deviation	V _{OD2}	--	±15	±20	mV	VO= AGND+0.5V ~ VDDA-0.5V
DC offset	V _{OS}			±20	mV	VO= AGND+0.5V ~ VDDA-0.5V
Dynamic output range	V _{DR}	0.1	--	AVDD-0.1	V	S1 ~ S1200
Pull high/low resistance	R _H	200	250	300	kΩ	For digital input pins at VDD=3.3V
Output sinking current	I _{OL}	80	--	--	μA	S1~S1200, VO =0.1V vs. 1.0V, VDDA=13.5V
Output driving current	I _{OH}	80	--	--	μA	S1~S1200, VO=13.4V vs. 12.5V, VDDA=13.5V
Analog operating current	I _{DDA}	--	10	12	mA	Without loading, FCLK=50MHz, FLD=48kHz, VDDA=10V, V1=8V, V14=0.4V
Digital operating current	I _{DD}	--	8	10	mA	FCLK=50MHz, FLD=48kHz, VDD=3.3V
Analog standby current	I _{STBA}	--	10	50	μA	No loading, clock and all functions are stopped
Digital standby current	I _{STBD}	--	10	50	μA	Clock and all functions are stopped

Note: VDD=3.0 ~ 3.6V, VDDA=6.5~13.5V, DGND=AGND=0V, Ta=-20~+85°C

7. AC Characteristics

7.1. AC Timing characteristics

DE Mode (MODE='1')

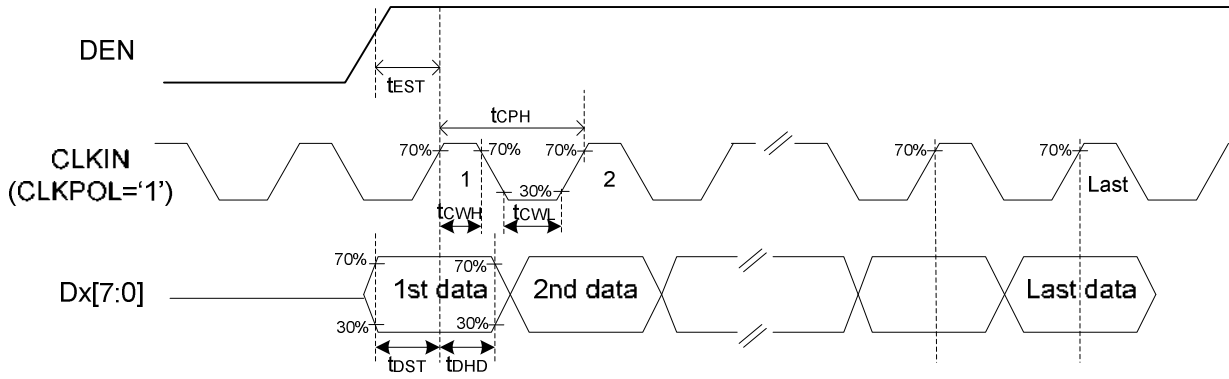

SYNC Mode (MODE='0')

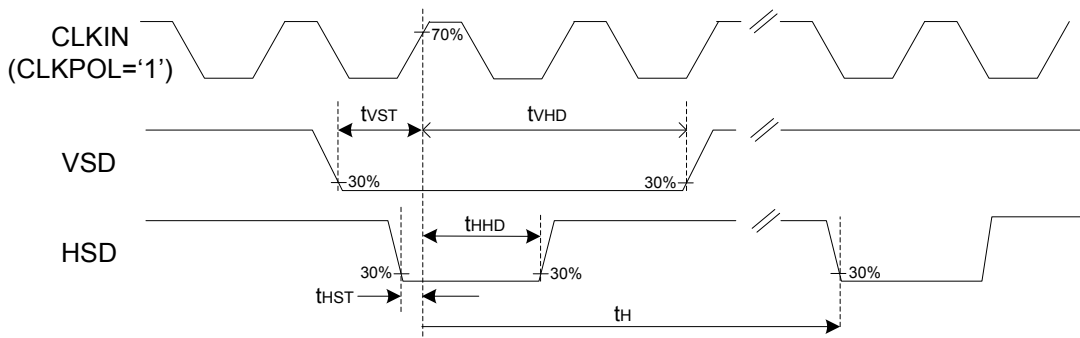

Source Output timing Diagram (Cascade)

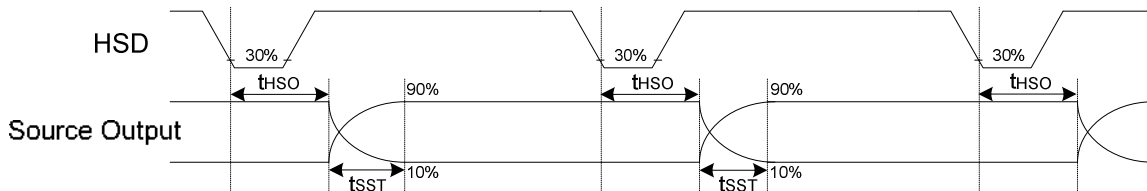

Vertical Timing Diagram of SYNC Mode (Dual Gate)

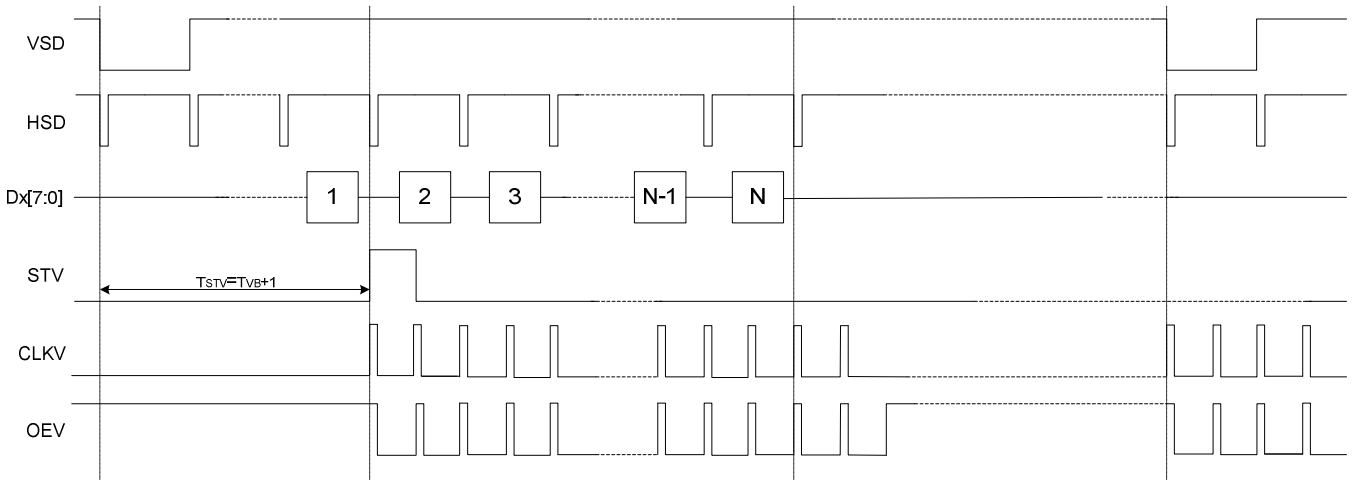

Vertical Timing Diagram of DE Mode (Dual Gate)

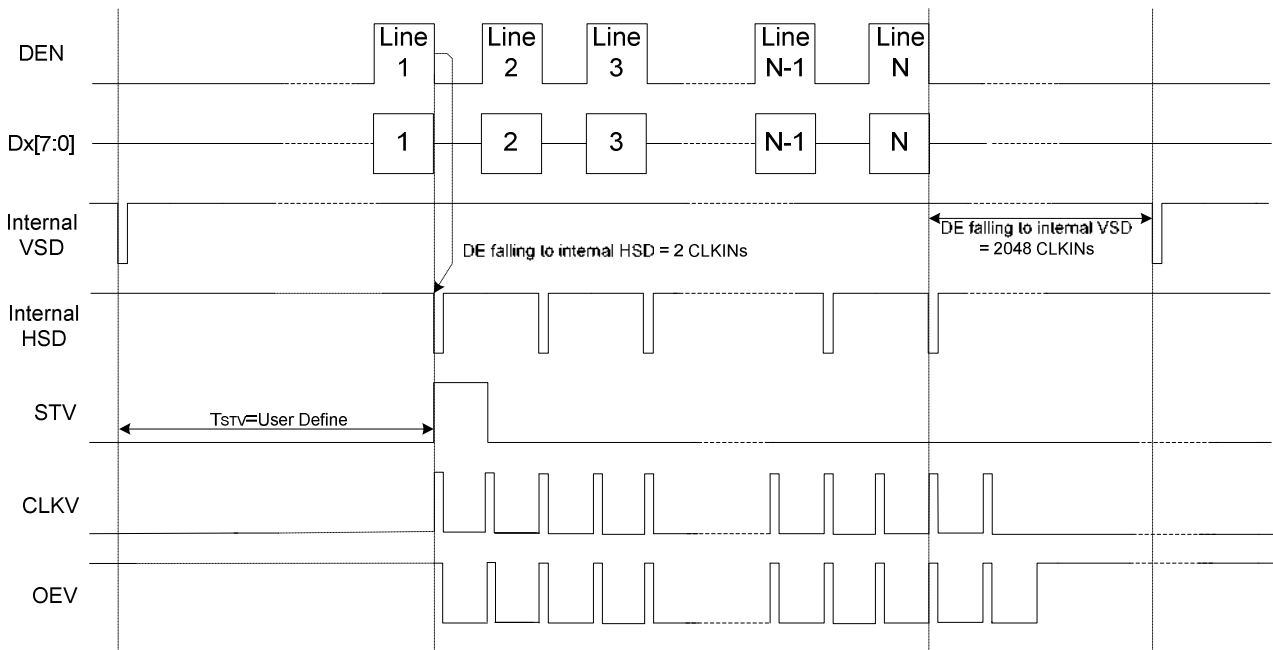

Gate Output Timing Diagram (Dual Gate)

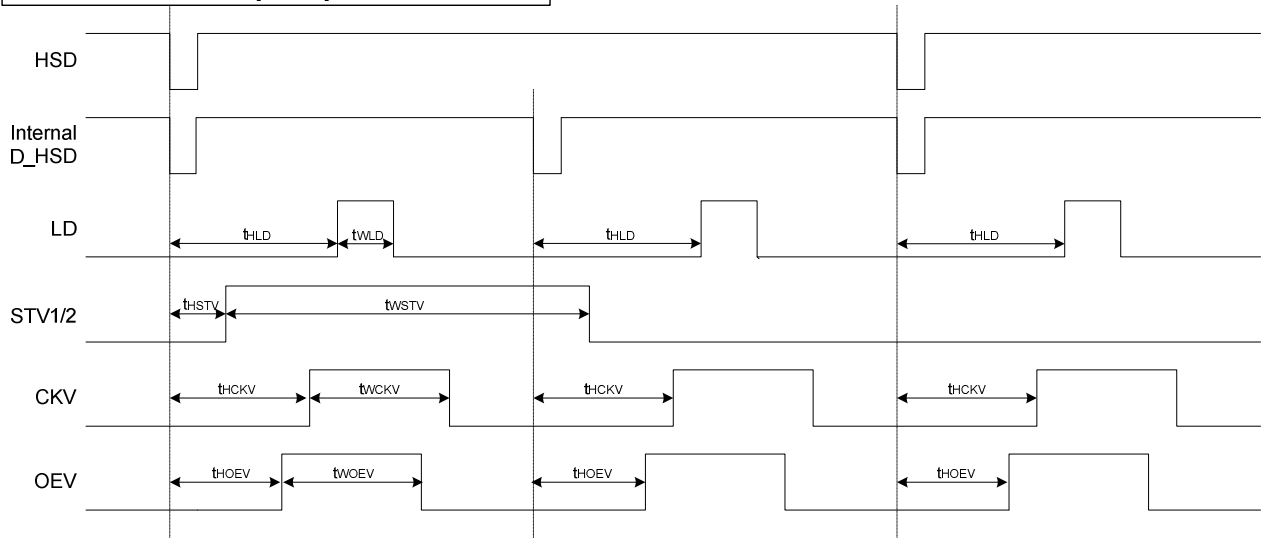

Parameter	Symbol	Spec			Unit	Conditions
		Min.	Typ.	Max.		
VDD Power ON slew rate	t_{POR}	--	--	20	ms	0V ~ 0.9VDD
RSTB pulse width	t_{RST}	10	--	--	us	CLKIN=50MHz
CLKIN cycle time	t_{CPH}	20	--	--	ns	
CLKIN pulse duty	t_{CWH}	40	50	60	%	
VSD setup time	t_{VST}	8	--	--	ns	
VSD hold time	t_{VHD}	8	--	--	ns	
HSD setup time	t_{HST}	8	--	--	ns	
HSD hold time	t_{HHD}	8	--	--	ns	
Data setup time	t_{DST}	8	--	--	ns	D0[7:0], D1[7:0], D2[7:0] to CLKIN
Data hold time	t_{DHD}	8	--	--	ns	D0[7:0], D1[7:0], D2[7:0] to CLKIN
DE setup time	t_{EST}	8	--	--	ns	
DE hold time	t_{EHD}	8	--	--	ns	
Output stable time	t_{SST}	--	--	6	us	10% to 90% target voltage. CL=120pF, R=10KΩ
CLKIN frequency	f_{CLK}	--	40	50	MHz	VDD=3.0 ~ 3.6V
CLKIN cycle time	t_{CLK}	20	25	--	ns	
CLKIN pulse duty	t_{CWH}	40	50	60	%	T_{CLK}
Time from HSD to Source output	t_{HSO}	--	20	--	CLKIN	
Time from HSD to LD	t_{HLD}	--	20	--	CLKIN	Note (2)
Time from HSD to STV	t_{HSTV}	--	2	--	CLKIN	
Time from HSD to CKV	t_{HCKV}	--	20	--	CLKIN	
Time from HSD to OEV	t_{HOEV}	--	4	--	CLKIN	
LD pulse width	t_{WLD}	--	10	--	CLKIN	Note (2)
CKV pulse width	t_{WCKV}	--	66	--	CLKIN	
OEV pulse width	t_{WOEV}	--	74	--	CLKIN	

Note: (1) VDD=3.0 ~ 3.6V, VDDA=6.5~13.5V, DGND=AGND=0V, Ta=-20~+85°C

(2) The contents of the data register are transferred to the latch circuit at the rising edge of LD. Then the gray scale voltage is output from the device at the falling edge of LD.

(3) Output loading condition :

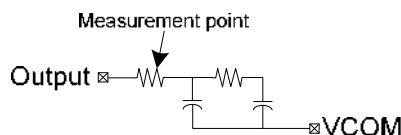

SPI Timing

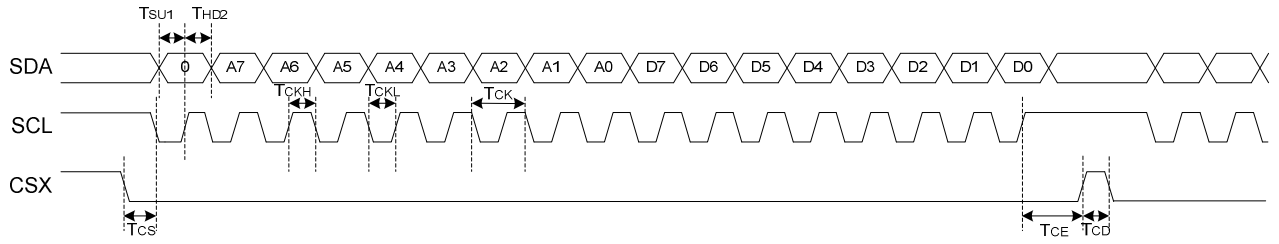

Parameter	Symbol	Spec			Unit	Conditions
		Min.	Typ.	Max.		
SCL period	T_{CK}	60	--	--	ns	
SCL high width	T_{CKH}	30	--	--	ns	
SCL low width	T_{CKL}	30	--	--	ns	
Data setup time	T_{SU1}	12	--	--	ns	
Data hold time	T_{HD1}	12	--	--	ns	
CSX to SCL setup time	T_{CS}	20	--	--	ns	
CSX to SDA hold time	T_{CE}	20	--	--	ns	
CSX high pulse width	T_{CD}	50	--	--	ns	

7.2. Display Timing characteristics

7.2.1. Resolution: 800x480

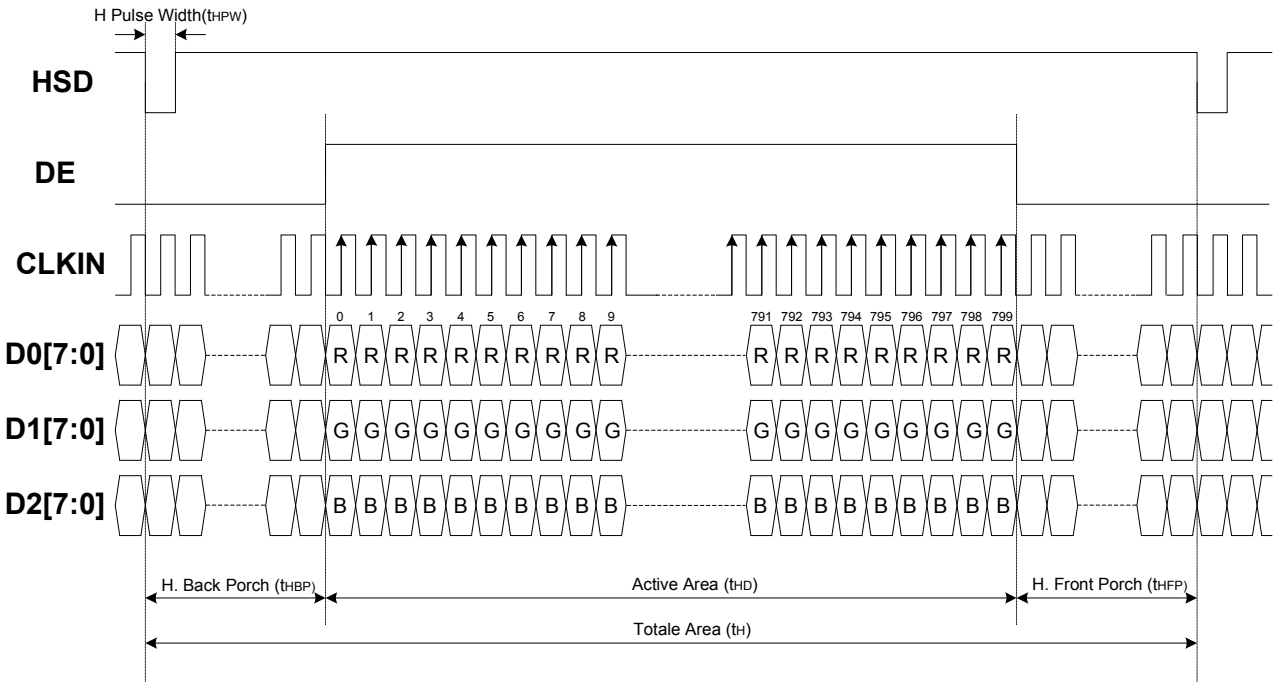

Horizontal Input Timing						
Parameter	Symbol	Value			Unit	
		Min.	Typ.	Max.		
Horizontal display area	t_{HD}	--	800	--	CLKIN	
CLKIN frequency	f_{CLK}	--	33.3	50	MHz	
1 Horizontal line period	t_H	862	1056	1200	CLKIN	
HSD pulse width	t_{HPW}	Min.	--	1	CLKIN	
		Typ.	--	--	CLKIN	
		Max.	--	40	CLKIN	
HSD back porch	SYNC	t_{HBP}	46	46	46	CLKIN
HSD front porch	SYNC	t_{HFP}	16	210	354	CLKIN

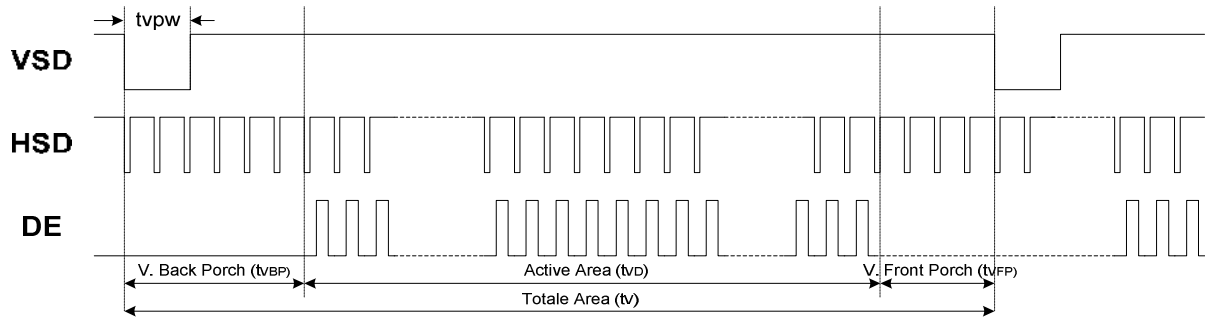

Vertical Input Timing					
Parameter	Symbol	Value			Unit
		Min.	Typ.	Max.	
Vertical display area	t_{vD}	--	480	--	HSD
VSD period time	t_v	510	525	650	HSD
VSD pulse width	t_{vPW}	1	--	20	HSD
VSD back porch	t_{vBP}	23	23	23	HSD
VSD front porch	t_{vFP}	7	22	147	HSD

7.2.2. Resolution: 800x600

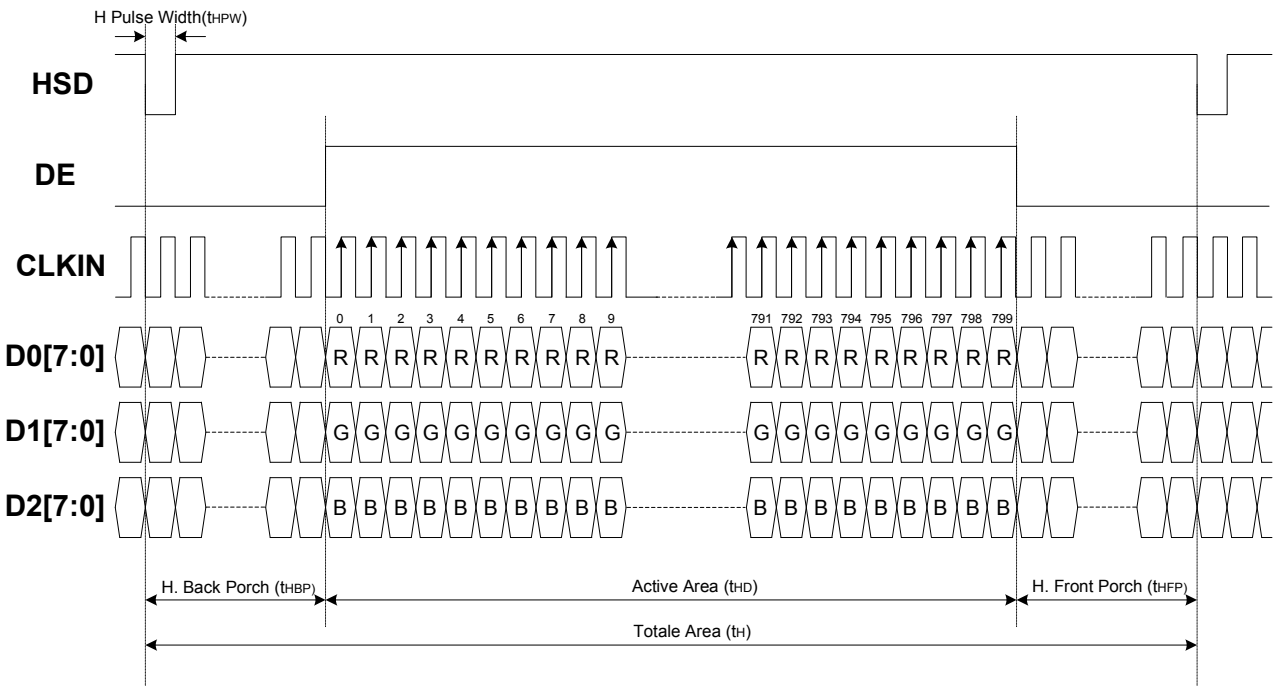

Horizontal Input Timing						
Parameter	Symbol	Value			Unit	
		Min.	Typ.	Max.		
Horizontal display area	t_{HD}	--	800	--	CLKIN	
CLKIN frequency	f_{CLK}	--	40	50	MHz	
1 Horizontal line period	t_H	862	1056	1200	CLKIN	
HSD pulse width	t_{HPW}	Min.	--	1	CLKIN	
		Typ.	--	--	CLKIN	
		Max.	--	40	CLKIN	
HSD back porch	SYNC	t_{HBP}	46	46	46	CLKIN
HSD front porch	SYNC	t_{HFP}	16	210	354	CLKIN

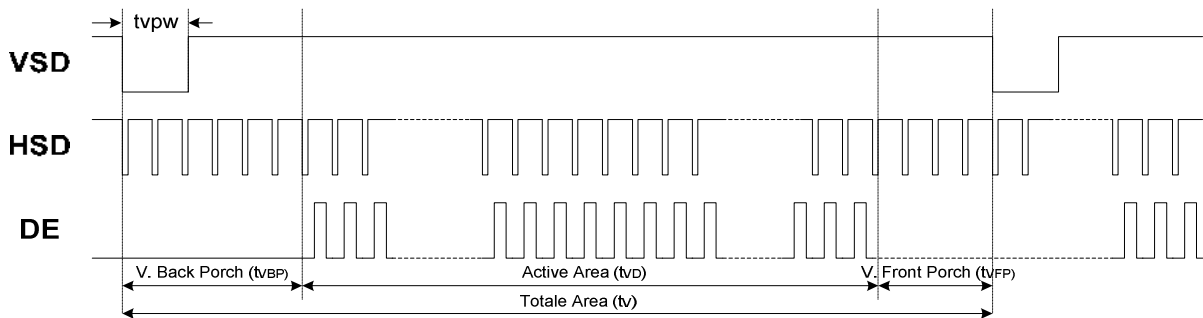

Vertical Input Timing					
Parameter	Symbol	Value			Unit
		Min.	Typ.	Max.	
Vertical display area	t_{VD}	--	600	--	HSD
VSD period time	t_V	624	635	700	HSD
VSD pulse width	t_{VPW}	1	--	20	HSD
VSD back proch	t_{VBP}	23	23	23	HSD
VSD front porch	t_{VFP}	1	12	77	HSD

9. Pad Arrangement and Coordination

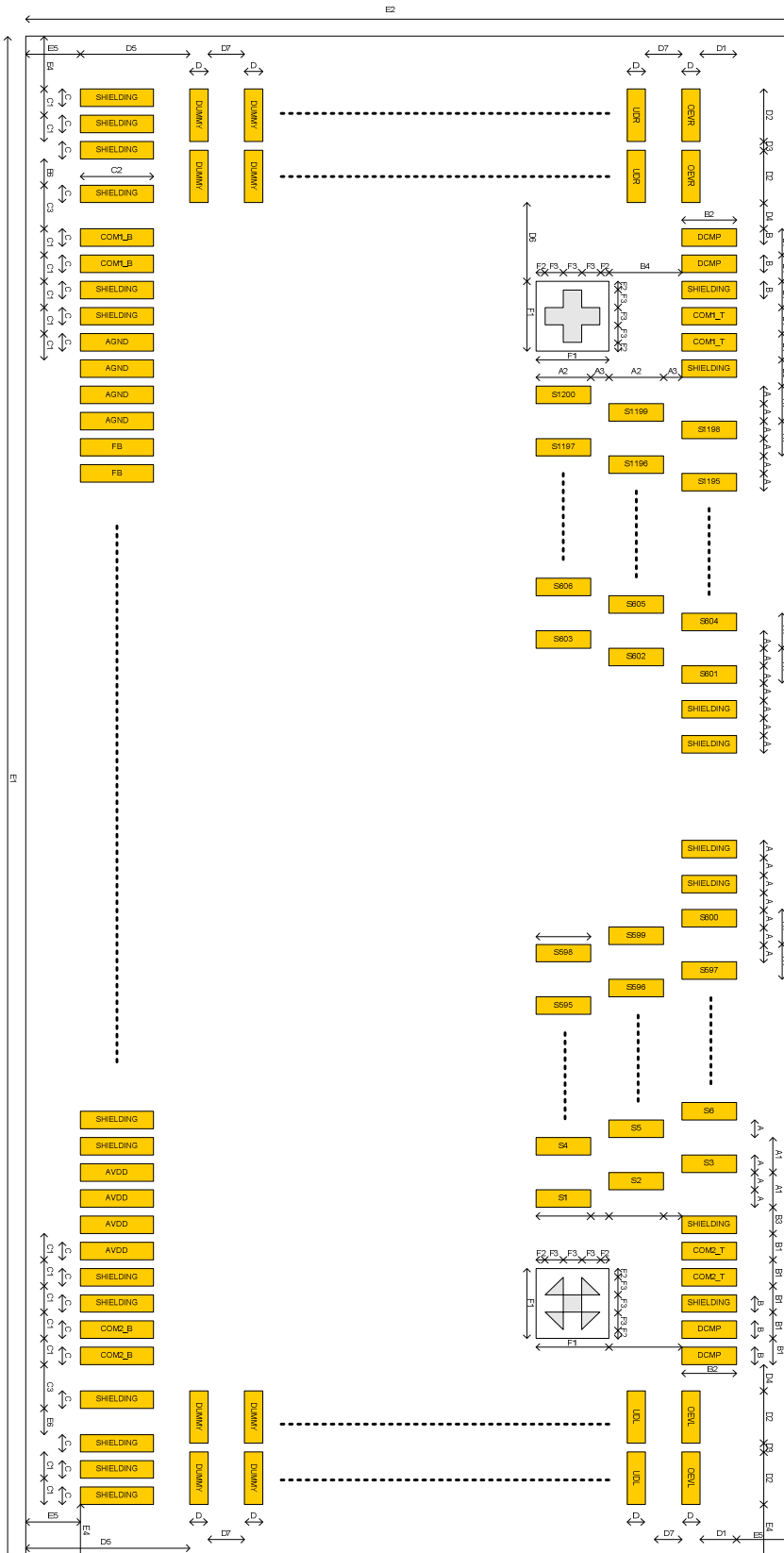

Symbol	Dimension (um)
A	17um
A1	34um
A2	110um
A3	30um
B	30um
B1	50um
B2	70um
B3	50um
B4	191.5um
C	65um
C1	85um
C2	110um
C3	115um
D	30um
D1	40um
D2	100um
D3	30um
D4	70um
D5	266um
D6	168.5um
D7	50um
E1	22578um (max.)
E2	1045um (max.)
E3	TBD
E4	57um (max.)
E5	57um (max.)
E6	136.5um
F1	115um
F2	20um
F3	25um

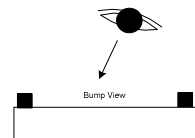

Chip size: 22498 um x 960 um.

Chip height: 400 um .

No.	Pad name	X	Y	No.	Pad name	X	Y	No.	Pad name	X	Y	No.	Pad name	X	Y
1	SHIELDING	-11196.5	-408	61	DBC/3	-5950	-408	121	V4	-850	-408	181	DEN	4250	-408
2	SHIELDING	-11111.5	-408	62	SHIELDING	-5865	-408	122	SHIELDING	-765	-408	182	DASHD	4335	-408
3	SHIELDING	-11026.5	-408	63	CLKPOL	-5780	-408	123	V5	-680	-408	183	CLKIN	4420	-408
4	SHIELDING	-10825	-408	64	CLKPOL	-5695	-408	124	V5	-595	-408	184	CLKIN	4505	-408
5	COM1_B	-10710	-408	65	SHIELDING	-5610	-408	125	SHIELDING	-510	-408	185	DASHD	4590	-408
6	COM1_B	-10625	-408	66	DITHB	-5525	-408	126	V6	-425	-408	186	D27	4675	-408
7	SHIELDING	-10540	-408	67	DITHB	-5440	-408	127	V6	-340	-408	187	D27	4760	-408
8	SHIELDING	-10455	-408	68	SHIELDING	-5355	-408	128	SHIELDING	-255	-408	188	D26	4845	-408
9	AGND	-10370	-408	69	MODE	-5270	-408	129	V7	-170	-408	189	D26	4930	-408
10	AGND	-10285	-408	70	MODE	-5185	-408	130	V7	-85	-408	190	DASHD	5015	-408
11	AGND	-10200	-408	71	SHIELDING	-5100	-408	131	SHIELDING	0	-408	191	D25	5100	-408
12	AGND	-10115	-408	72	SHLR	-5015	-408	132	V8	85	-408	192	D25	5185	-408
13	SHIELDING	-10030	-408	73	SHLR	-4930	-408	133	V8	170	-408	193	D24	5270	-408
14	FB (Reserved)	-9945	-408	74	SHIELDING	-4845	-408	134	SHIELDING	255	-408	194	D24	5355	-408
15	FB (Reserved)	-9860	-408	75	UPDN	-4760	-408	135	V9	340	-408	195	DASHD	5440	-408
16	SHIELDING	-9775	-408	76	UPDN	-4675	-408	136	V9	425	-408	196	D23	5525	-408
17	DRV (Reserved)	-9690	-408	77	SHIELDING	-4590	-408	137	SHIELDING	510	-408	197	D23	5610	-408
18	DRV (Reserved)	-9605	-408	78	STBYB	-4505	-408	138	V10	595	-408	198	D22	5695	-408
19	TP0	-9520	-408	79	STBYB	-4420	-408	139	V10	680	-408	199	D22	5780	-408
20	TP0	-9435	-408	80	SHIELDING	-4335	-408	140	SHIELDING	765	-408	200	DASHD	5865	-408
21	TP1	-9350	-408	81	RSTB	-4250	-408	141	V11	850	-408	201	D21	5950	-408
22	TP1	-9265	-408	82	RSTB	-4165	-408	142	V11	935	-408	202	D21	6035	-408
23	TP2	-9180	-408	83	SHIELDING	-4080	-408	143	SHIELDING	1020	-408	203	D20	6120	-408
24	TP2	-9095	-408	84	BLKEN	-3995	-408	144	V12	1105	-408	204	D20	6205	-408
25	TP3	-9010	-408	85	BLKEN	-3910	-408	145	V12	1190	-408	205	DASHD	6290	-408
26	TP3	-8925	-408	86	SHIELDING	-3825	-408	146	SHIELDING	1275	-408	206	D17	6375	-408
27	TP4	-8840	-408	87	VSET	-3740	-408	147	V13	1360	-408	207	D17	6460	-408
28	TP4	-8755	-408	88	VSET	-3655	-408	148	V13	1445	-408	208	D16	6545	-408
29	TP5	-8670	-408	89	TP6	-3570	-408	149	SHIELDING	1530	-408	209	D16	6630	-408
30	TP5	-8585	-408	90	TP6	-3485	-408	150	V14	1615	-408	210	DASHD	6715	-408
31	SHIELDING	-8500	-408	91	TP7	-3400	-408	151	V14	1700	-408	211	D15	6800	-408
32	INVSEL	-8415	-408	92	TP7	-3315	-408	152	SHIELDING	1785	-408	212	D15	6885	-408
33	INVSEL	-8330	-408	93	TP8	-3230	-408	153	AGND	1870	-408	213	D14	6970	-408
34	SHIELDING	-8245	-408	94	TP8	-3145	-408	154	AGND	1955	-408	214	D14	7055	-408
35	CABC_EN	-8160	-408	95	TP9	-3060	-408	155	AGND	2040	-408	215	DASHD	7140	-408
36	CABC_EN	-8075	-408	96	TP9	-2975	-408	156	AGND	2125	-408	216	D13	7225	-408
37	SHIELDING	-7990	-408	97	TP10	-2890	-408	157	AGND	2210	-408	217	D13	7310	-408
38	PWM_EN (Reserved)	-7905	-408	98	TP10	-2805	-408	158	AGND	2295	-408	218	D12	7395	-408
39	PWM_EN (Reserved)	-7820	-408	99	DCMP_EN	-2720	-408	159	AGND	2380	-408	219	D12	7480	-408
40	SHIELDING	-7735	-408	100	DUMMY	-2635	-408	160	AGND	2465	-408	220	DASHD	7565	-408
41	CSX	-7650	-408	101	SHIELDING	-2550	-408	161	SHIELDING	2550	-408	221	D11	7650	-408
42	CSX	-7565	-408	102	AVDD	-2465	-408	162	SHIELDING	2635	-408	222	D11	7735	-408
43	SHIELDING	-7480	-408	103	AVDD	-2380	-408	163	GND	2720	-408	223	D10	7820	-408
44	SCL	-7395	-408	104	AVDD	-2295	-408	164	GND	2805	-408	224	D10	7905	-408
45	SCL	-7310	-408	105	AVDD	-2210	-408	165	GND	2890	-408	225	DASHD	7990	-408
46	SHIELDING	-7225	-408	106	AVDD	-2125	-408	166	GND	2975	-408	226	D07	8075	-408
47	SCL/DBCM[0]	-7140	-408	107	AVDD	-2040	-408	167	SHIELDING	3060	-408	227	D07	8160	-408
48	SDA/DBCM[1]	-7055	-408	108	AVDD	-1955	-408	168	SHIELDING	3145	-408	228	D06	8245	-408
49	SHIELDING	-6970	-408	109	AVDD	-1870	-408	169	VDD	3230	-408	229	D06	8330	-408
50	SHIELDING	-6885	-408	110	SHIELDING	-1785	-408	170	VDD	3315	-408	230	DASHD	8415	-408
51	GOSEQ	-6800	-408	111	V1	-1700	-408	171	VDD	3400	-408	231	D05	8500	-408
52	GOSEQ	-6715	-408	112	V1	-1615	-408	172	VDD	3485	-408	232	D05	8585	-408
53	SHIELDING	-6630	-408	113	SHIELDING	-1530	-408	173	DASHD	3570	-408	233	D04	8670	-408
54	BIST	-6545	-408	114	V2	-1445	-408	174	VSD	3655	-408	234	D04	8755	-408
55	BIST	-6460	-408	115	V2	-1360	-408	175	VSD	3740	-408	235	DASHD	8840	-408
56	SHIELDING	-6375	-408	116	SHIELDING	-1275	-408	176	DASHD	3825	-408	236	D03	8925	-408
57	RES0	-6290	-408	117	V3	-1190	-408	177	HSD	3910	-408	237	D03	9010	-408
58	RES0	-6205	-408	118	V3	-1105	-408	178	HSD	3995	-408	238	D02	9095	-408
59	SHIELDING	-6120	-408	119	SHIELDING	-1020	-408	179	DASHD	4080	-408	239	D02	9180	-408
60	DBC/3	-6035	-408	120	V4	-935	-408	180	DEN	4165	-408	240	DASHD	9265	-408

No.	Pad name	X	Y	No.	Pad name	X	Y	No.	Pad name	X	Y	No.	Pad name	X	Y
241	D01	9350	-408	301	SO[16]	10365.5	128	361	SO[76]	9345.5	128	421	SO[136]	8325.5	128
242	D01	9435	-408	302	SO[17]	10348.5	268	362	SO[77]	9328.5	268	422	SO[137]	8308.5	268
243	D00	9520	-408	303	SO[18]	10331.5	408	363	SO[78]	9311.5	408	423	SO[138]	8291.5	408
244	D00	9605	-408	304	SO[19]	10314.5	128	364	SO[79]	9294.5	128	424	SO[139]	8274.5	128
245	DASHD	9690	-408	305	SO[20]	10297.5	268	365	SO[80]	9277.5	268	425	SO[140]	8257.5	268
246	SHIELDING	9775	-408	306	SO[21]	10280.5	408	366	SO[81]	9260.5	408	426	SO[141]	8240.5	408
247	SHIELDING	9860	-408	307	SO[22]	10263.5	128	367	SO[82]	9243.5	128	427	SO[142]	8223.5	128
248	SHIELDING	9945	-408	308	SO[23]	10246.5	268	368	SO[83]	9226.5	268	428	SO[143]	8206.5	268
249	SHIELDING	10030	-408	309	SO[24]	10229.5	408	369	SO[84]	9209.5	408	429	SO[144]	8189.5	408
250	AVDD	10115	-408	310	SO[25]	10212.5	128	370	SO[85]	9192.5	128	430	SO[145]	8172.5	128
251	AVDD	10200	-408	311	SO[26]	10195.5	268	371	SO[86]	9175.5	268	431	SO[146]	8155.5	268
252	AVDD	10285	-408	312	SO[27]	10178.5	408	372	SO[87]	9158.5	408	432	SO[147]	8138.5	408
253	AVDD	10370	-408	313	SO[28]	10161.5	128	373	SO[88]	9141.5	128	433	SO[148]	8121.5	128
254	SHIELDING	10455	-408	314	SO[29]	10144.5	268	374	SO[89]	9124.5	268	434	SO[149]	8104.5	268
255	SHIELDING	10540	-408	315	SO[30]	10127.5	408	375	SO[90]	9107.5	408	435	SO[150]	8087.5	408
256	COM2_B	10625	-408	316	SO[31]	10110.5	128	376	SO[91]	9090.5	128	436	SO[151]	8070.5	128
257	COM2_B	10710	-408	317	SO[32]	10093.5	268	377	SO[92]	9073.5	268	437	SO[152]	8053.5	268
258	SHIELDING	10825	-408	318	SO[33]	10076.5	408	378	SO[93]	9056.5	408	438	SO[153]	8036.5	408
259	SHIELDING	11026.5	-408	319	SO[34]	10059.5	128	379	SO[94]	9039.5	128	439	SO[154]	8019.5	128
260	SHIELDING	11111.5	-408	320	SO[35]	10042.5	268	380	SO[95]	9022.5	268	440	SO[155]	8002.5	268
261	SHIELDING	11196.5	-408	321	SO[36]	10025.5	408	381	SO[96]	9005.5	408	441	SO[156]	7985.5	408
262	DUMMY	11049	-232	322	SO[37]	10008.5	128	382	SO[97]	8988.5	128	442	SO[157]	7968.5	128
263	DUMMY	11179	-232	323	SO[38]	9991.5	268	383	SO[98]	8971.5	268	443	SO[158]	7951.5	268
264	STBNL	11049	-152	324	SO[39]	9974.5	408	384	SO[99]	8954.5	408	444	SO[159]	7934.5	408
265	STBNL	11179	-152	325	SO[40]	9957.5	128	385	SO[100]	8937.5	128	445	SO[160]	7917.5	128
266	STV1L	11049	-72	326	SO[41]	9940.5	268	386	SO[101]	8920.5	268	446	SO[161]	7900.5	268
267	STV1L	11179	-72	327	SO[42]	9923.5	408	387	SO[102]	8903.5	408	447	SO[162]	7883.5	408
268	STV2L	11049	8	328	SO[43]	9906.5	128	388	SO[103]	8886.5	128	448	SO[163]	7866.5	128
269	STV2L	11179	8	329	SO[44]	9889.5	268	389	SO[104]	8869.5	268	449	SO[164]	7849.5	268
270	STV1L	11049	88	330	SO[45]	9872.5	408	390	SO[105]	8852.5	408	450	SO[165]	7832.5	408
271	STV1L	11179	88	331	SO[46]	9855.5	128	391	SO[106]	8835.5	128	451	SO[166]	7815.5	128
272	CKVL	11049	168	332	SO[47]	9838.5	268	392	SO[107]	8818.5	268	452	SO[167]	7798.5	268
273	CKVL	11179	168	333	SO[48]	9821.5	408	393	SO[108]	8801.5	408	453	SO[168]	7781.5	408
274	UDL	11049	248	334	SO[49]	9804.5	128	394	SO[109]	8784.5	128	454	SO[169]	7764.5	128
275	UDL	11179	248	335	SO[50]	9787.5	268	395	SO[110]	8767.5	268	455	SO[170]	7747.5	268
276	OEVL	11179	328	336	SO[51]	9770.5	408	396	SO[111]	8750.5	408	456	SO[171]	7730.5	408
277	INVBRL	11179	408	337	SO[52]	9753.5	128	397	SO[112]	8733.5	128	457	SO[172]	7713.5	128
278	OEVL	11049	328	338	SO[53]	9736.5	268	398	SO[113]	8716.5	268	458	SO[173]	7696.5	268
279	INVBRL	11049	408	339	SO[54]	9719.5	408	399	SO[114]	8699.5	408	459	SO[174]	7679.5	408
280	DCMPL	10914	428	340	SO[55]	9702.5	128	400	SO[115]	8682.5	128	460	SO[175]	7662.5	128
281	DCMPL	10864	428	341	SO[56]	9685.5	268	401	SO[116]	8665.5	268	461	SO[176]	7645.5	268
282	SHIELDING	10814	428	342	SO[57]	9668.5	408	402	SO[117]	8648.5	408	462	SO[177]	7628.5	408
283	COM2_T	10764	428	343	SO[58]	9651.5	128	403	SO[118]	8631.5	128	463	SO[178]	7611.5	128
284	COM2_T	10714	428	344	SO[59]	9634.5	268	404	SO[119]	8614.5	268	464	SO[179]	7594.5	268
285	SHIELDING	10664	428	345	SO[60]	9617.5	408	405	SO[120]	8597.5	408	465	SO[180]	7577.5	408
286	SO[1]	10620.5	128	346	SO[61]	9600.5	128	406	SO[121]	8580.5	128	466	SO[181]	7560.5	128
287	SO[2]	10603.5	268	347	SO[62]	9583.5	268	407	SO[122]	8563.5	268	467	SO[182]	7543.5	268
288	SO[3]	10586.5	408	348	SO[63]	9566.5	408	408	SO[123]	8546.5	408	468	SO[183]	7526.5	408
289	SO[4]	10569.5	128	349	SO[64]	9549.5	128	409	SO[124]	8529.5	128	469	SO[184]	7509.5	128
290	SO[5]	10552.5	268	350	SO[65]	9532.5	268	410	SO[125]	8512.5	268	470	SO[185]	7492.5	268
291	SO[6]	10535.5	408	351	SO[66]	9515.5	408	411	SO[126]	8495.5	408	471	SO[186]	7475.5	408
292	SO[7]	10518.5	128	352	SO[67]	9498.5	128	412	SO[127]	8478.5	128	472	SO[187]	7458.5	128
293	SO[8]	10501.5	268	353	SO[68]	9481.5	268	413	SO[128]	8461.5	268	473	SO[188]	7441.5	268
294	SO[9]	10484.5	408	354	SO[69]	9464.5	408	414	SO[129]	8444.5	408	474	SO[189]	7424.5	408
295	SO[10]	10467.5	128	355	SO[70]	9447.5	128	415	SO[130]	8427.5	128	475	SO[190]	7407.5	128
296	SO[11]	10450.5	268	356	SO[71]	9430.5	268	416	SO[131]	8410.5	268	476	SO[191]	7390.5	268
297	SO[12]	10433.5	408	357	SO[72]	9413.5	408	417	SO[132]	8393.5	408	477	SO[192]	7373.5	408
298	SO[13]	10416.5	128	358	SO[73]	9396.5	128	418	SO[133]	8376.5	128	478	SO[193]	7356.5	128
299	SO[14]	10399.5	268	359	SO[74]	9379.5	268	419	SO[134]	8359.5	268	479	SO[194]	7339.5	268
300	SO[15]	10382.5	408	360	SO[75]	9362.5	408	420	SO[135]	8342.5	408	480	SO[195]	7322.5	408

No.	Pad name	X	Y	No.	Pad name	X	Y	No.	Pad name	X	Y	No.	Pad name	X	Y
481	SO[196]	7305.5	128	541	SO[256]	6285.5	128	601	SO[316]	5265.5	128	661	SO[376]	4245.5	128
482	SO[197]	7288.5	268	542	SO[257]	6268.5	268	602	SO[317]	5248.5	268	662	SO[377]	4228.5	268
483	SO[198]	7271.5	408	543	SO[258]	6251.5	408	603	SO[318]	5231.5	408	663	SO[378]	4211.5	408
484	SO[199]	7254.5	128	544	SO[259]	6234.5	128	604	SO[319]	5214.5	128	664	SO[379]	4194.5	128
485	SO[200]	7237.5	268	545	SO[260]	6217.5	268	605	SO[320]	5197.5	268	665	SO[380]	4177.5	268
486	SO[201]	7220.5	408	546	SO[261]	6200.5	408	606	SO[321]	5180.5	408	666	SO[381]	4160.5	408
487	SO[202]	7203.5	128	547	SO[262]	6183.5	128	607	SO[322]	5163.5	128	667	SO[382]	4143.5	128
488	SO[203]	7186.5	268	548	SO[263]	6166.5	268	608	SO[323]	5146.5	268	668	SO[383]	4126.5	268
489	SO[204]	7169.5	408	549	SO[264]	6149.5	408	609	SO[324]	5129.5	408	669	SO[384]	4109.5	408
490	SO[205]	7152.5	128	550	SO[265]	6132.5	128	610	SO[325]	5112.5	128	670	SO[385]	4092.5	128
491	SO[206]	7135.5	268	551	SO[266]	6115.5	268	611	SO[326]	5095.5	268	671	SO[386]	4075.5	268
492	SO[207]	7118.5	408	552	SO[267]	6098.5	408	612	SO[327]	5078.5	408	672	SO[387]	4058.5	408
493	SO[208]	7101.5	128	553	SO[268]	6081.5	128	613	SO[328]	5061.5	128	673	SO[388]	4041.5	128
494	SO[209]	7084.5	268	554	SO[269]	6064.5	268	614	SO[329]	5044.5	268	674	SO[389]	4024.5	268
495	SO[210]	7067.5	408	555	SO[270]	6047.5	408	615	SO[330]	5027.5	408	675	SO[390]	4007.5	408
496	SO[211]	7050.5	128	556	SO[271]	6030.5	128	616	SO[331]	5010.5	128	676	SO[391]	3990.5	128
497	SO[212]	7033.5	268	557	SO[272]	6013.5	268	617	SO[332]	4993.5	268	677	SO[392]	3973.5	268
498	SO[213]	7016.5	408	558	SO[273]	5996.5	408	618	SO[333]	4976.5	408	678	SO[393]	3956.5	408
499	SO[214]	6999.5	128	559	SO[274]	5979.5	128	619	SO[334]	4959.5	128	679	SO[394]	3939.5	128
500	SO[215]	6982.5	268	560	SO[275]	5962.5	268	620	SO[335]	4942.5	268	680	SO[395]	3922.5	268
501	SO[216]	6965.5	408	561	SO[276]	5945.5	408	621	SO[336]	4925.5	408	681	SO[396]	3905.5	408
502	SO[217]	6948.5	128	562	SO[277]	5928.5	128	622	SO[337]	4908.5	128	682	SO[397]	3888.5	128
503	SO[218]	6931.5	268	563	SO[278]	5911.5	268	623	SO[338]	4891.5	268	683	SO[398]	3871.5	268
504	SO[219]	6914.5	408	564	SO[279]	5894.5	408	624	SO[339]	4874.5	408	684	SO[399]	3854.5	408
505	SO[220]	6897.5	128	565	SO[280]	5877.5	128	625	SO[340]	4857.5	128	685	SO[400]	3837.5	128
506	SO[221]	6880.5	268	566	SO[281]	5860.5	268	626	SO[341]	4840.5	268	686	SO[401]	3820.5	268
507	SO[222]	6863.5	408	567	SO[282]	5843.5	408	627	SO[342]	4823.5	408	687	SO[402]	3803.5	408
508	SO[223]	6846.5	128	568	SO[283]	5826.5	128	628	SO[343]	4806.5	128	688	SO[403]	3786.5	128
509	SO[224]	6829.5	268	569	SO[284]	5809.5	268	629	SO[344]	4789.5	268	689	SO[404]	3769.5	268
510	SO[225]	6812.5	408	570	SO[285]	5792.5	408	630	SO[345]	4772.5	408	690	SO[405]	3752.5	408
511	SO[226]	6795.5	128	571	SO[286]	5775.5	128	631	SO[346]	4755.5	128	691	SO[406]	3735.5	128
512	SO[227]	6778.5	268	572	SO[287]	5758.5	268	632	SO[347]	4738.5	268	692	SO[407]	3718.5	268
513	SO[228]	6761.5	408	573	SO[288]	5741.5	408	633	SO[348]	4721.5	408	693	SO[408]	3701.5	408
514	SO[229]	6744.5	128	574	SO[289]	5724.5	128	634	SO[349]	4704.5	128	694	SO[409]	3684.5	128
515	SO[230]	6727.5	268	575	SO[290]	5707.5	268	635	SO[350]	4687.5	268	695	SO[410]	3667.5	268
516	SO[231]	6710.5	408	576	SO[291]	5690.5	408	636	SO[351]	4670.5	408	696	SO[411]	3650.5	408
517	SO[232]	6693.5	128	577	SO[292]	5673.5	128	637	SO[352]	4653.5	128	697	SO[412]	3633.5	128
518	SO[233]	6676.5	268	578	SO[293]	5656.5	268	638	SO[353]	4636.5	268	698	SO[413]	3616.5	268
519	SO[234]	6659.5	408	579	SO[294]	5639.5	408	639	SO[354]	4619.5	408	699	SO[414]	3599.5	408
520	SO[235]	6642.5	128	580	SO[295]	5622.5	128	640	SO[355]	4602.5	128	700	SO[415]	3582.5	128
521	SO[236]	6625.5	268	581	SO[296]	5605.5	268	641	SO[356]	4585.5	268	701	SO[416]	3565.5	268
522	SO[237]	6608.5	408	582	SO[297]	5588.5	408	642	SO[357]	4568.5	408	702	SO[417]	3548.5	408
523	SO[238]	6591.5	128	583	SO[298]	5571.5	128	643	SO[358]	4551.5	128	703	SO[418]	3531.5	128
524	SO[239]	6574.5	268	584	SO[299]	5554.5	268	644	SO[359]	4534.5	268	704	SO[419]	3514.5	268
525	SO[240]	6557.5	408	585	SO[300]	5537.5	408	645	SO[360]	4517.5	408	705	SO[420]	3497.5	408
526	SO[241]	6540.5	128	586	SO[301]	5520.5	128	646	SO[361]	4500.5	128	706	SO[421]	3480.5	128
527	SO[242]	6523.5	268	587	SO[302]	5503.5	268	647	SO[362]	4483.5	268	707	SO[422]	3463.5	268
528	SO[243]	6506.5	408	588	SO[303]	5486.5	408	648	SO[363]	4466.5	408	708	SO[423]	3446.5	408
529	SO[244]	6489.5	128	589	SO[304]	5469.5	128	649	SO[364]	4449.5	128	709	SO[424]	3429.5	128
530	SO[245]	6472.5	268	590	SO[305]	5452.5	268	650	SO[365]	4432.5	268	710	SO[425]	3412.5	268
531	SO[246]	6455.5	408	591	SO[306]	5435.5	408	651	SO[366]	4415.5	408	711	SO[426]	3395.5	408
532	SO[247]	6438.5	128	592	SO[307]	5418.5	128	652	SO[367]	4398.5	128	712	SO[427]	3378.5	128
533	SO[248]	6421.5	268	593	SO[308]	5401.5	268	653	SO[368]	4381.5	268	713	SO[428]	3361.5	268
534	SO[249]	6404.5	408	594	SO[309]	5384.5	408	654	SO[369]	4364.5	408	714	SO[429]	3344.5	408
535	SO[250]	6387.5	128	595	SO[310]	5367.5	128	655	SO[370]	4347.5	128	715	SO[430]	3327.5	128
536	SO[251]	6370.5	268	596	SO[311]	5350.5	268	656	SO[371]	4330.5	268	716	SO[431]	3310.5	268
537	SO[252]	6353.5	408	597	SO[312]	5333.5	408	657	SO[372]	4313.5	408	717	SO[432]	3293.5	408
538	SO[253]	6336.5	128	598	SO[313]	5316.5	128	658	SO[373]	4296.5	128	718	SO[433]	3276.5	128
539	SO[254]	6319.5	268	599	SO[314]	5299.5	268	659	SO[374]	4279.5	268	719	SO[434]	3259.5	268
540	SO[255]	6302.5	408	600	SO[315]	5282.5	408	660	SO[375]	4262.5	408	720	SO[435]	3242.5	408

No.	Pad name	X	Y	No.	Pad name	X	Y	No.	Pad name	X	Y	No.	Pad name	X	Y
721	SO[436]	3225.5	128	781	SO[496]	2205.5	128	841	SO[556]	1185.5	128	901	SO[604]	-488.5	408
722	SO[437]	3208.5	268	782	SO[497]	2188.5	268	842	SO[557]	1168.5	268	902	SO[605]	-505.5	268
723	SO[438]	3191.5	408	783	SO[498]	2171.5	408	843	SO[558]	1151.5	408	903	SO[606]	-522.5	128
724	SO[439]	3174.5	128	784	SO[499]	2154.5	128	844	SO[559]	1134.5	128	904	SO[607]	-539.5	408
725	SO[440]	3157.5	268	785	SO[500]	2137.5	268	845	SO[560]	1117.5	268	905	SO[608]	-556.5	268
726	SO[441]	3140.5	408	786	SO[501]	2120.5	408	846	SO[561]	1100.5	408	906	SO[609]	-573.5	128
727	SO[442]	3123.5	128	787	SO[502]	2103.5	128	847	SO[562]	1083.5	128	907	SO[610]	-590.5	408
728	SO[443]	3106.5	268	788	SO[503]	2086.5	268	848	SO[563]	1066.5	268	908	SO[611]	-607.5	268
729	SO[444]	3089.5	408	789	SO[504]	2069.5	408	849	SO[564]	1049.5	408	909	SO[612]	-624.5	128
730	SO[445]	3072.5	128	790	SO[505]	2052.5	128	850	SO[565]	1032.5	128	910	SO[613]	-641.5	408
731	SO[446]	3055.5	268	791	SO[506]	2035.5	268	851	SO[566]	1015.5	268	911	SO[614]	-658.5	268
732	SO[447]	3038.5	408	792	SO[507]	2018.5	408	852	SO[567]	998.5	408	912	SO[615]	-675.5	128
733	SO[448]	3021.5	128	793	SO[508]	2001.5	128	853	SO[568]	981.5	128	913	SO[616]	-692.5	408
734	SO[449]	3004.5	268	794	SO[509]	1984.5	268	854	SO[569]	964.5	268	914	SO[617]	-709.5	268
735	SO[450]	2987.5	408	795	SO[510]	1967.5	408	855	SO[570]	947.5	408	915	SO[618]	-726.5	128
736	SO[451]	2970.5	128	796	SO[511]	1950.5	128	856	SO[571]	930.5	128	916	SO[619]	-743.5	408
737	SO[452]	2953.5	268	797	SO[512]	1933.5	268	857	SO[572]	913.5	268	917	SO[620]	-760.5	268
738	SO[453]	2936.5	408	798	SO[513]	1916.5	408	858	SO[573]	896.5	408	918	SO[621]	-777.5	128
739	SO[454]	2919.5	128	799	SO[514]	1899.5	128	859	SO[574]	879.5	128	919	SO[622]	-794.5	408
740	SO[455]	2902.5	268	800	SO[515]	1882.5	268	860	SO[575]	862.5	268	920	SO[623]	-811.5	268
741	SO[456]	2885.5	408	801	SO[516]	1865.5	408	861	SO[576]	845.5	408	921	SO[624]	-828.5	128
742	SO[457]	2868.5	128	802	SO[517]	1848.5	128	862	SO[577]	828.5	128	922	SO[625]	-845.5	408
743	SO[458]	2851.5	268	803	SO[518]	1831.5	268	863	SO[578]	811.5	268	923	SO[626]	-862.5	268
744	SO[459]	2834.5	408	804	SO[519]	1814.5	408	864	SO[579]	794.5	408	924	SO[627]	-879.5	128
745	SO[460]	2817.5	128	805	SO[520]	1797.5	128	865	SO[580]	777.5	128	925	SO[628]	-896.5	408
746	SO[461]	2800.5	268	806	SO[521]	1780.5	268	866	SO[581]	760.5	268	926	SO[629]	-913.5	268
747	SO[462]	2783.5	408	807	SO[522]	1763.5	408	867	SO[582]	743.5	408	927	SO[630]	-930.5	128
748	SO[463]	2766.5	128	808	SO[523]	1746.5	128	868	SO[583]	726.5	128	928	SO[631]	-947.5	408
749	SO[464]	2749.5	268	809	SO[524]	1729.5	268	869	SO[584]	709.5	268	929	SO[632]	-964.5	268
750	SO[465]	2732.5	408	810	SO[525]	1712.5	408	870	SO[585]	692.5	408	930	SO[633]	-981.5	128
751	SO[466]	2715.5	128	811	SO[526]	1695.5	128	871	SO[586]	675.5	128	931	SO[634]	-998.5	408
752	SO[467]	2698.5	268	812	SO[527]	1678.5	268	872	SO[587]	658.5	268	932	SO[635]	-1015.5	268
753	SO[468]	2681.5	408	813	SO[528]	1661.5	408	873	SO[588]	641.5	408	933	SO[636]	-1032.5	128
754	SO[469]	2664.5	128	814	SO[529]	1644.5	128	874	SO[589]	624.5	128	934	SO[637]	-1049.5	408
755	SO[470]	2647.5	268	815	SO[530]	1627.5	268	875	SO[590]	607.5	268	935	SO[638]	-1066.5	268
756	SO[471]	2630.5	408	816	SO[531]	1610.5	408	876	SO[591]	590.5	408	936	SO[639]	-1083.5	128
757	SO[472]	2613.5	128	817	SO[532]	1593.5	128	877	SO[592]	573.5	128	937	SO[640]	-1100.5	408
758	SO[473]	2596.5	268	818	SO[533]	1576.5	268	878	SO[593]	556.5	268	938	SO[641]	-1117.5	268
759	SO[474]	2579.5	408	819	SO[534]	1559.5	408	879	SO[594]	539.5	408	939	SO[642]	-1134.5	128
760	SO[475]	2562.5	128	820	SO[535]	1542.5	128	880	SO[595]	522.5	128	940	SO[643]	-1151.5	408
761	SO[476]	2545.5	268	821	SO[536]	1525.5	268	881	SO[596]	505.5	268	941	SO[644]	-1168.5	268
762	SO[477]	2528.5	408	822	SO[537]	1508.5	408	882	SO[597]	488.5	408	942	SO[645]	-1185.5	128
763	SO[478]	2511.5	128	823	SO[538]	1491.5	128	883	SO[598]	471.5	128	943	SO[646]	-1202.5	408
764	SO[479]	2494.5	268	824	SO[539]	1474.5	268	884	SO[599]	454.5	268	944	SO[647]	-1219.5	268
765	SO[480]	2477.5	408	825	SO[540]	1457.5	408	885	SO[600]	437.5	408	945	SO[648]	-1236.5	128
766	SO[481]	2460.5	128	826	SO[541]	1440.5	128	886	SHIELDING	403.5	408	946	SO[649]	-1253.5	408
767	SO[482]	2443.5	268	827	SO[542]	1423.5	268	887	SHIELDING	369.5	408	947	SO[650]	-1270.5	268
768	SO[483]	2426.5	408	828	SO[543]	1406.5	408	888	SHIELDING	335.5	408	948	SO[651]	-1287.5	128
769	SO[484]	2409.5	128	829	SO[544]	1389.5	128	889	SHIELDING	301.5	408	949	SO[652]	-1304.5	408
770	SO[485]	2392.5	268	830	SO[545]	1372.5	268	890	SHIELDING	267.5	408	950	SO[653]	-1321.5	268
771	SO[486]	2375.5	408	831	SO[546]	1355.5	408	891	SHIELDING	233.5	408	951	SO[654]	-1338.5	128
772	SO[487]	2358.5	128	832	SO[547]	1338.5	128	892	SHIELDING	-233.5	408	952	SO[655]	-1355.5	408
773	SO[488]	2341.5	268	833	SO[548]	1321.5	268	893	SHIELDING	-267.5	408	953	SO[656]	-1372.5	268
774	SO[489]	2324.5	408	834	SO[549]	1304.5	408	894	SHIELDING	-301.5	408	954	SO[657]	-1389.5	128
775	SO[490]	2307.5	128	835	SO[550]	1287.5	128	895	SHIELDING	-335.5	408	955	SO[658]	-1406.5	408
776	SO[491]	2290.5	268	836	SO[551]	1270.5	268	896	SHIELDING	-369.5	408	956	SO[659]	-1423.5	268
777	SO[492]	2273.5	408	837	SO[552]	1253.5	408	897	SHIELDING	-403.5	408	957	SO[660]	-1440.5	128
778	SO[493]	2256.5	128	838	SO[553]	1236.5	128	898	SO[601]	-437.5	408	958	SO[661]	-1457.5	408
779	SO[494]	2239.5	268	839	SO[554]	1219.5	268	899	SO[602]	-454.5	268	959	SO[662]	-1474.5	268
780	SO[495]	2222.5	408	840	SO[555]	1202.5	408	900	SO[603]	-471.5	128	960	SO[663]	-1491.5	128

No.	Pad name	X	Y	No.	Pad name	X	Y	No.	Pad name	X	Y	No.	Pad name	X	Y
961	SO[664]	-1508.5	408	1021	SO[724]	-2528.5	408	1081	SO[784]	-3548.5	408	1141	SO[844]	-4568.5	408
962	SO[665]	-1525.5	268	1022	SO[725]	-2545.5	268	1082	SO[785]	-3565.5	268	1142	SO[845]	-4585.5	268
963	SO[666]	-1542.5	128	1023	SO[726]	-2562.5	128	1083	SO[786]	-3582.5	128	1143	SO[846]	-4602.5	128
964	SO[667]	-1559.5	408	1024	SO[727]	-2579.5	408	1084	SO[787]	-3599.5	408	1144	SO[847]	-4619.5	408
965	SO[668]	-1576.5	268	1025	SO[728]	-2596.5	268	1085	SO[788]	-3616.5	268	1145	SO[848]	-4636.5	268
966	SO[669]	-1593.5	128	1026	SO[729]	-2613.5	128	1086	SO[789]	-3633.5	128	1146	SO[849]	-4653.5	128
967	SO[670]	-1610.5	408	1027	SO[730]	-2630.5	408	1087	SO[790]	-3650.5	408	1147	SO[850]	-4670.5	408
968	SO[671]	-1627.5	268	1028	SO[731]	-2647.5	268	1088	SO[791]	-3667.5	268	1148	SO[851]	-4687.5	268
969	SO[672]	-1644.5	128	1029	SO[732]	-2664.5	128	1089	SO[792]	-3684.5	128	1149	SO[852]	-4704.5	128
970	SO[673]	-1661.5	408	1030	SO[733]	-2681.5	408	1090	SO[793]	-3701.5	408	1150	SO[853]	-4721.5	408
971	SO[674]	-1678.5	268	1031	SO[734]	-2698.5	268	1091	SO[794]	-3718.5	268	1151	SO[854]	-4738.5	268
972	SO[675]	-1695.5	128	1032	SO[735]	-2715.5	128	1092	SO[795]	-3735.5	128	1152	SO[855]	-4755.5	128
973	SO[676]	-1712.5	408	1033	SO[736]	-2732.5	408	1093	SO[796]	-3752.5	408	1153	SO[856]	-4772.5	408
974	SO[677]	-1729.5	268	1034	SO[737]	-2749.5	268	1094	SO[797]	-3769.5	268	1154	SO[857]	-4789.5	268
975	SO[678]	-1746.5	128	1035	SO[738]	-2766.5	128	1095	SO[798]	-3786.5	128	1155	SO[858]	-4806.5	128
976	SO[679]	-1763.5	408	1036	SO[739]	-2783.5	408	1096	SO[799]	-3803.5	408	1156	SO[859]	-4823.5	408
977	SO[680]	-1780.5	268	1037	SO[740]	-2800.5	268	1097	SO[800]	-3820.5	268	1157	SO[860]	-4840.5	268
978	SO[681]	-1797.5	128	1038	SO[741]	-2817.5	128	1098	SO[801]	-3837.5	128	1158	SO[861]	-4857.5	128
979	SO[682]	-1814.5	408	1039	SO[742]	-2834.5	408	1099	SO[802]	-3854.5	408	1159	SO[862]	-4874.5	408
980	SO[683]	-1831.5	268	1040	SO[743]	-2851.5	268	1100	SO[803]	-3871.5	268	1160	SO[863]	-4891.5	268
981	SO[684]	-1848.5	128	1041	SO[744]	-2868.5	128	1101	SO[804]	-3888.5	128	1161	SO[864]	-4908.5	128
982	SO[685]	-1865.5	408	1042	SO[745]	-2885.5	408	1102	SO[805]	-3905.5	408	1162	SO[865]	-4925.5	408
983	SO[686]	-1882.5	268	1043	SO[746]	-2902.5	268	1103	SO[806]	-3922.5	268	1163	SO[866]	-4942.5	268
984	SO[687]	-1899.5	128	1044	SO[747]	-2919.5	128	1104	SO[807]	-3939.5	128	1164	SO[867]	-4959.5	128
985	SO[688]	-1916.5	408	1045	SO[748]	-2936.5	408	1105	SO[808]	-3956.5	408	1165	SO[868]	-4976.5	408
986	SO[689]	-1933.5	268	1046	SO[749]	-2953.5	268	1106	SO[809]	-3973.5	268	1166	SO[869]	-4993.5	268
987	SO[690]	-1950.5	128	1047	SO[750]	-2970.5	128	1107	SO[810]	-3990.5	128	1167	SO[870]	-5010.5	128
988	SO[691]	-1967.5	408	1048	SO[751]	-2987.5	408	1108	SO[811]	-4007.5	408	1168	SO[871]	-5027.5	408
989	SO[692]	-1984.5	268	1049	SO[752]	-3004.5	268	1109	SO[812]	-4024.5	268	1169	SO[872]	-5044.5	268
990	SO[693]	-2001.5	128	1050	SO[753]	-3021.5	128	1110	SO[813]	-4041.5	128	1170	SO[873]	-5061.5	128
991	SO[694]	-2018.5	408	1051	SO[754]	-3038.5	408	1111	SO[814]	-4058.5	408	1171	SO[874]	-5078.5	408
992	SO[695]	-2035.5	268	1052	SO[755]	-3055.5	268	1112	SO[815]	-4075.5	268	1172	SO[875]	-5095.5	268
993	SO[696]	-2052.5	128	1053	SO[756]	-3072.5	128	1113	SO[816]	-4092.5	128	1173	SO[876]	-5112.5	128
994	SO[697]	-2069.5	408	1054	SO[757]	-3089.5	408	1114	SO[817]	-4109.5	408	1174	SO[877]	-5129.5	408
995	SO[698]	-2086.5	268	1055	SO[758]	-3106.5	268	1115	SO[818]	-4126.5	268	1175	SO[878]	-5146.5	268
996	SO[699]	-2103.5	128	1056	SO[759]	-3123.5	128	1116	SO[819]	-4143.5	128	1176	SO[879]	-5163.5	128
997	SO[700]	-2120.5	408	1057	SO[760]	-3140.5	408	1117	SO[820]	-4160.5	408	1177	SO[880]	-5180.5	408
998	SO[701]	-2137.5	268	1058	SO[761]	-3157.5	268	1118	SO[821]	-4177.5	268	1178	SO[881]	-5197.5	268
999	SO[702]	-2154.5	128	1059	SO[762]	-3174.5	128	1119	SO[822]	-4194.5	128	1179	SO[882]	-5214.5	128
1000	SO[703]	-2171.5	408	1060	SO[763]	-3191.5	408	1120	SO[823]	-4211.5	408	1180	SO[883]	-5231.5	408
1001	SO[704]	-2188.5	268	1061	SO[764]	-3208.5	268	1121	SO[824]	-4228.5	268	1181	SO[884]	-5248.5	268
1002	SO[705]	-2205.5	128	1062	SO[765]	-3225.5	128	1122	SO[825]	-4245.5	128	1182	SO[885]	-5265.5	128
1003	SO[706]	-2222.5	408	1063	SO[766]	-3242.5	408	1123	SO[826]	-4262.5	408	1183	SO[886]	-5282.5	408
1004	SO[707]	-2239.5	268	1064	SO[767]	-3259.5	268	1124	SO[827]	-4279.5	268	1184	SO[887]	-5299.5	268
1005	SO[708]	-2256.5	128	1065	SO[768]	-3276.5	128	1125	SO[828]	-4296.5	128	1185	SO[888]	-5316.5	128
1006	SO[709]	-2273.5	408	1066	SO[769]	-3293.5	408	1126	SO[829]	-4313.5	408	1186	SO[889]	-5333.5	408
1007	SO[710]	-2290.5	268	1067	SO[770]	-3310.5	268	1127	SO[830]	-4330.5	268	1187	SO[890]	-5350.5	268
1008	SO[711]	-2307.5	128	1068	SO[771]	-3327.5	128	1128	SO[831]	-4347.5	128	1188	SO[891]	-5367.5	128
1009	SO[712]	-2324.5	408	1069	SO[772]	-3344.5	408	1129	SO[832]	-4364.5	408	1189	SO[892]	-5384.5	408
1010	SO[713]	-2341.5	268	1070	SO[773]	-3361.5	268	1130	SO[833]	-4381.5	268	1190	SO[893]	-5401.5	268
1011	SO[714]	-2358.5	128	1071	SO[774]	-3378.5	128	1131	SO[834]	-4398.5	128	1191	SO[894]	-5418.5	128
1012	SO[715]	-2375.5	408	1072	SO[775]	-3395.5	408	1132	SO[835]	-4415.5	408	1192	SO[895]	-5435.5	408
1013	SO[716]	-2392.5	268	1073	SO[776]	-3412.5	268	1133	SO[836]	-4432.5	268	1193	SO[896]	-5452.5	268
1014	SO[717]	-2409.5	128	1074	SO[777]	-3429.5	128	1134	SO[837]	-4449.5	128	1194	SO[897]	-5469.5	128
1015	SO[718]	-2426.5	408	1075	SO[778]	-3446.5	408	1135	SO[838]	-4466.5	408	1195	SO[898]	-5486.5	408
1016	SO[719]	-2443.5	268	1076	SO[779]	-3463.5	268	1136	SO[839]	-4483.5	268	1196	SO[899]	-5503.5	268
1017	SO[720]	-2460.5	128	1077	SO[780]	-3480.5	128	1137	SO[840]	-4500.5	128	1197	SO[900]	-5520.5	128
1018	SO[721]	-2477.5	408	1078	SO[781]	-3497.5	408	1138	SO[841]	-4517.5	408	1198	SO[901]	-5537.5	408
1019	SO[722]	-2494.5	268	1079	SO[782]	-3514.5	268	1139	SO[842]	-4534.5	268	1199	SO[902]	-5554.5	268
1020	SO[723]	-2511.5	128	1080	SO[783]	-3531.5	128	1140	SO[843]	-4551.5	128	1200	SO[903]	-5571.5	128

No.	Pad name	X	Y	No.	Pad name	X	Y	No.	Pad name	X	Y	No.	Pad name	X	Y
1201	SO[904]	-5588.5	408	1261	SO[964]	-6608.5	408	1321	SO[1024]	-7628.5	408	1381	SO[1084]	-8648.5	408
1202	SO[905]	-5605.5	268	1262	SO[965]	-6625.5	268	1322	SO[1025]	-7645.5	268	1382	SO[1085]	-8665.5	268
1203	SO[906]	-5622.5	128	1263	SO[966]	-6642.5	128	1323	SO[1026]	-7662.5	128	1383	SO[1086]	-8682.5	128
1204	SO[907]	-5639.5	408	1264	SO[967]	-6659.5	408	1324	SO[1027]	-7679.5	408	1384	SO[1087]	-8699.5	408
1205	SO[908]	-5656.5	268	1265	SO[968]	-6676.5	268	1325	SO[1028]	-7696.5	268	1385	SO[1088]	-8716.5	268
1206	SO[909]	-5673.5	128	1266	SO[969]	-6693.5	128	1326	SO[1029]	-7713.5	128	1386	SO[1089]	-8733.5	128
1207	SO[910]	-5690.5	408	1267	SO[970]	-6710.5	408	1327	SO[1030]	-7730.5	408	1387	SO[1090]	-8750.5	408
1208	SO[911]	-5707.5	268	1268	SO[971]	-6727.5	268	1328	SO[1031]	-7747.5	268	1388	SO[1091]	-8767.5	268
1209	SO[912]	-5724.5	128	1269	SO[972]	-6744.5	128	1329	SO[1032]	-7764.5	128	1389	SO[1092]	-8784.5	128
1210	SO[913]	-5741.5	408	1270	SO[973]	-6761.5	408	1330	SO[1033]	-7781.5	408	1390	SO[1093]	-8801.5	408
1211	SO[914]	-5758.5	268	1271	SO[974]	-6778.5	268	1331	SO[1034]	-7798.5	268	1391	SO[1094]	-8818.5	268
1212	SO[915]	-5775.5	128	1272	SO[975]	-6795.5	128	1332	SO[1035]	-7815.5	128	1392	SO[1095]	-8835.5	128
1213	SO[916]	-5792.5	408	1273	SO[976]	-6812.5	408	1333	SO[1036]	-7832.5	408	1393	SO[1096]	-8852.5	408
1214	SO[917]	-5809.5	268	1274	SO[977]	-6829.5	268	1334	SO[1037]	-7849.5	268	1394	SO[1097]	-8869.5	268
1215	SO[918]	-5826.5	128	1275	SO[978]	-6846.5	128	1335	SO[1038]	-7866.5	128	1395	SO[1098]	-8886.5	128
1216	SO[919]	-5843.5	408	1276	SO[979]	-6863.5	408	1336	SO[1039]	-7883.5	408	1396	SO[1099]	-8903.5	408
1217	SO[920]	-5860.5	268	1277	SO[980]	-6880.5	268	1337	SO[1040]	-7900.5	268	1397	SO[1100]	-8920.5	268
1218	SO[921]	-5877.5	128	1278	SO[981]	-6897.5	128	1338	SO[1041]	-7917.5	128	1398	SO[1101]	-8937.5	128
1219	SO[922]	-5894.5	408	1279	SO[982]	-6914.5	408	1339	SO[1042]	-7934.5	408	1399	SO[1102]	-8954.5	408
1220	SO[923]	-5911.5	268	1280	SO[983]	-6931.5	268	1340	SO[1043]	-7951.5	268	1400	SO[1103]	-8971.5	268
1221	SO[924]	-5928.5	128	1281	SO[984]	-6948.5	128	1341	SO[1044]	-7968.5	128	1401	SO[1104]	-8988.5	128
1222	SO[925]	-5945.5	408	1282	SO[985]	-6965.5	408	1342	SO[1045]	-7985.5	408	1402	SO[1105]	-9005.5	408
1223	SO[926]	-5962.5	268	1283	SO[986]	-6982.5	268	1343	SO[1046]	-8002.5	268	1403	SO[1106]	-9022.5	268
1224	SO[927]	-5979.5	128	1284	SO[987]	-6999.5	128	1344	SO[1047]	-8019.5	128	1404	SO[1107]	-9039.5	128
1225	SO[928]	-5996.5	408	1285	SO[988]	-7016.5	408	1345	SO[1048]	-8036.5	408	1405	SO[1108]	-9056.5	408
1226	SO[929]	-6013.5	268	1286	SO[989]	-7033.5	268	1346	SO[1049]	-8053.5	268	1406	SO[1109]	-9073.5	268
1227	SO[930]	-6030.5	128	1287	SO[990]	-7050.5	128	1347	SO[1050]	-8070.5	128	1407	SO[1110]	-9090.5	128
1228	SO[931]	-6047.5	408	1288	SO[991]	-7067.5	408	1348	SO[1051]	-8087.5	408	1408	SO[1111]	-9107.5	408
1229	SO[932]	-6064.5	268	1289	SO[992]	-7084.5	268	1349	SO[1052]	-8104.5	268	1409	SO[1112]	-9124.5	268
1230	SO[933]	-6081.5	128	1290	SO[993]	-7101.5	128	1350	SO[1053]	-8121.5	128	1410	SO[1113]	-9141.5	128
1231	SO[934]	-6098.5	408	1291	SO[994]	-7118.5	408	1351	SO[1054]	-8138.5	408	1411	SO[1114]	-9158.5	408
1232	SO[935]	-6115.5	268	1292	SO[995]	-7135.5	268	1352	SO[1055]	-8155.5	268	1412	SO[1115]	-9175.5	268
1233	SO[936]	-6132.5	128	1293	SO[996]	-7152.5	128	1353	SO[1056]	-8172.5	128	1413	SO[1116]	-9192.5	128
1234	SO[937]	-6149.5	408	1294	SO[997]	-7169.5	408	1354	SO[1057]	-8189.5	408	1414	SO[1117]	-9209.5	408
1235	SO[938]	-6166.5	268	1295	SO[998]	-7186.5	268	1355	SO[1058]	-8206.5	268	1415	SO[1118]	-9226.5	268
1236	SO[939]	-6183.5	128	1296	SO[999]	-7203.5	128	1356	SO[1059]	-8223.5	128	1416	SO[1119]	-9243.5	128
1237	SO[940]	-6200.5	408	1297	SO[1000]	-7220.5	408	1357	SO[1060]	-8240.5	408	1417	SO[1120]	-9260.5	408
1238	SO[941]	-6217.5	268	1298	SO[1001]	-7237.5	268	1358	SO[1061]	-8257.5	268	1418	SO[1121]	-9277.5	268
1239	SO[942]	-6234.5	128	1299	SO[1002]	-7254.5	128	1359	SO[1062]	-8274.5	128	1419	SO[1122]	-9294.5	128
1240	SO[943]	-6251.5	408	1300	SO[1003]	-7271.5	408	1360	SO[1063]	-8291.5	408	1420	SO[1123]	-9311.5	408
1241	SO[944]	-6268.5	268	1301	SO[1004]	-7288.5	268	1361	SO[1064]	-8308.5	268	1421	SO[1124]	-9328.5	268
1242	SO[945]	-6285.5	128	1302	SO[1005]	-7305.5	128	1362	SO[1065]	-8325.5	128	1422	SO[1125]	-9345.5	128
1243	SO[946]	-6302.5	408	1303	SO[1006]	-7322.5	408	1363	SO[1066]	-8342.5	408	1423	SO[1126]	-9362.5	408
1244	SO[947]	-6319.5	268	1304	SO[1007]	-7339.5	268	1364	SO[1067]	-8359.5	268	1424	SO[1127]	-9379.5	268
1245	SO[948]	-6336.5	128	1305	SO[1008]	-7356.5	128	1365	SO[1068]	-8376.5	128	1425	SO[1128]	-9396.5	128
1246	SO[949]	-6353.5	408	1306	SO[1009]	-7373.5	408	1366	SO[1069]	-8393.5	408	1426	SO[1129]	-9413.5	408
1247	SO[950]	-6370.5	268	1307	SO[1010]	-7390.5	268	1367	SO[1070]	-8410.5	268	1427	SO[1130]	-9430.5	268
1248	SO[951]	-6387.5	128	1308	SO[1011]	-7407.5	128	1368	SO[1071]	-8427.5	128	1428	SO[1131]	-9447.5	128
1249	SO[952]	-6404.5	408	1309	SO[1012]	-7424.5	408	1369	SO[1072]	-8444.5	408	1429	SO[1132]	-9464.5	408
1250	SO[953]	-6421.5	268	1310	SO[1013]	-7441.5	268	1370	SO[1073]	-8461.5	268	1430	SO[1133]	-9481.5	268
1251	SO[954]	-6438.5	128	1311	SO[1014]	-7458.5	128	1371	SO[1074]	-8478.5	128	1431	SO[1134]	-9498.5	128
1252	SO[955]	-6455.5	408	1312	SO[1015]	-7475.5	408	1372	SO[1075]	-8495.5	408	1432	SO[1135]	-9515.5	408
1253	SO[956]	-6472.5	268	1313	SO[1016]	-7492.5	268	1373	SO[1076]	-8512.5	268	1433	SO[1136]	-9532.5	268
1254	SO[957]	-6489.5	128	1314	SO[1017]	-7509.5	128	1374	SO[1077]	-8529.5	128	1434	SO[1137]	-9549.5	128
1255	SO[958]	-6506.5	408	1315	SO[1018]	-7526.5	408	1375	SO[1078]	-8546.5	408	1435	SO[1138]	-9566.5	408
1256	SO[959]	-6523.5	268	1316	SO[1019]	-7543.5	268	1376	SO[1079]	-8563.5	268	1436	SO[1139]	-9583.5	268
1257	SO[960]	-6540.5	128	1317	SO[1020]	-7560.5	128	1377	SO[1080]	-8580.5	128	1437	SO[1140]	-9600.5	128
1258	SO[961]	-6557.5	408	1318	SO[1021]	-7577.5	408	1378	SO[1081]	-8597.5	408	1438	SO[1141]	-9617.5	408
1259	SO[962]	-6574.5	268	1319	SO[1022]	-7594.5	268	1379	SO[1082]	-8614.5	268	1439	SO[1142]	-9634.5	268
1260	SO[963]	-6591.5	128	1320	SO[1023]	-7611.5	128	1380	SO[1083]	-8631.5	128	1440	SO[1143]	-9651.5	128

Pad name	X	Y	No.	Pad name	X	Y
SO[1144]	-9668.5	408	1501	SHIELDING	-10814	428
SO[1145]	-9685.5	268	1502	DCMPR	-10864	428
SO[1146]	-9702.5	128	1503	DCMPR	-10914	428
SO[1147]	-9719.5	408	1504	OEVR	-11049	328
SO[1148]	-9736.5	268	1505	INVBRR	-11049	408
SO[1149]	-9753.5	128	1506	INVBRR	-11179	408
SO[1150]	-9770.5	408	1507	OEVR	-11179	328
SO[1151]	-9787.5	268	1508	UDR	-11179	248
SO[1152]	-9804.5	128	1509	UDR	-11049	248
SO[1153]	-9821.5	408	1510	CKVR	-11179	168
SO[1154]	-9838.5	268	1511	CKVR	-11049	168
SO[1155]	-9855.5	128	1512	STV1R	-11179	88
SO[1156]	-9872.5	408	1513	STV1R	-11049	88
SO[1157]	-9889.5	268	1514	STV2R	-11179	8
SO[1158]	-9906.5	128	1515	STV2R	-11049	8
SO[1159]	-9923.5	408	1516	STV1R	-11179	-72
SO[1160]	-9940.5	268	1517	STV1R	-11049	-72
SO[1161]	-9957.5	128	1518	STBNR	-11179	-152
SO[1162]	-9974.5	408	1519	STBNR	-11049	-152
SO[1163]	-9991.5	268	1520	DUMMY	-11179	-232
SO[1164]	-10008.5	128	1521	DUMMY	-11049	-232
SO[1165]	-10025.5	408				
SO[1166]	-10042.5	268				
SO[1167]	-10059.5	128				
SO[1168]	-10076.5	408				
SO[1169]	-10093.5	268				
SO[1170]	-10110.5	128				
SO[1171]	-10127.5	408				
SO[1172]	-10144.5	268				
SO[1173]	-10161.5	128				
SO[1174]	-10178.5	408				
SO[1175]	-10195.5	268				
SO[1176]	-10212.5	128				
SO[1177]	-10229.5	408				
SO[1178]	-10246.5	268				
SO[1179]	-10263.5	128				
SO[1180]	-10280.5	408				
SO[1181]	-10297.5	268				
SO[1182]	-10314.5	128				
SO[1183]	-10331.5	408				
SO[1184]	-10348.5	268				
SO[1185]	-10365.5	128				
SO[1186]	-10382.5	408				
SO[1187]	-10399.5	268				
SO[1188]	-10416.5	128				
SO[1189]	-10433.5	408				
SO[1190]	-10450.5	268				
SO[1191]	-10467.5	128				
SO[1192]	-10484.5	408				
SO[1193]	-10501.5	268				
SO[1194]	-10518.5	128				
SO[1195]	-10535.5	408				
SO[1196]	-10552.5	268				
SO[1197]	-10569.5	128				
SO[1198]	-10586.5	408				
SO[1199]	-10603.5	268				
SO[1200]	-10620.5	128				
SHIELDING	-10664	428				
COM1_T	-10714	428				
COM1_T	-10764	428				

10. Revision History

Version No.	Date	Page	Description
Spec_0.01	2009/06/23	P08	Modify DCMP_EM (Normally pull low)→ (Normally pull high) Modify UPDN (Normally pull low)→ (Normally pull high)
Spec_0.02	2009/09/25	P34	Modify Analog operating current TBD→ Typ=10mA Max=12mA Modify Digital operating current TBD → Typ=8mA Max=10mA Modify Analog standby current TBD → Typ=10uA Max=50uA Modify Digital standby current TBD→ Typ=10uA Max=50uA Add Chip size: 22498 um x 960 um.
		P43	Add Chip height: 400 um .
Spec_0.03	2009/10/15	P50	Modify the pad location.
Spec_0.04	2009/11/13	P14	Modify Dot Polarity Inversion Diagram.
		P11	Add Pin Descriptions.(FB 、 DRV 、 PWM_EN)
		P7	Add Application Block Diagram.
Spec_0.05	2009/12/14	P27	Add Register Default Value Table
		P28~35	Add Register Default Value
		P31	Modify BLKEN Frequency Specification.
Spec_0.06	2010/01/06	P7/P9/P21	Add Application Block Diagram of 800X480 with ILI5960
Spec_0.07	2010/04/08	P30	Modify Content Adaptive Brightness Control register address "55H"→"82H"
Spec_0.08	2010/04/13	P14	Add Hardware Pin Control CABC Mode Selection