



ORIENT DISPLAY

Your Total LCD Solution Provider

Specification for TFT

AFR320480A0-2.35INTH-I

Revision V1.0



A	Orient Display
FR	TFT Type
320480	Resolution 320x480
A0	Serial A0
2.35	2.35", Module Dimension 39.52x60.68x2.3 mm
I	IPS Display
N	Top: -20~+70°C; Tstr: -30~+80°C
T	Transmissive/Normally Black
H	High Brightness, 750cd/m ²
I	2-lane MIPI
/	No Touch Panel
/	Controller ST7701S



Contents

1. DESCRIPTION.....	4
2. BLOCK DIAGRAM.....	5
3. OUTLINE DIMENSION	6
4. INPUT TERMINAL PIN ASSIGNMENT.....	7
5. LCD OPTICAL CHARACTERISTICS.....	8
5.1 OPTICAL SPECIFICATION.....	8
6. ELECTRICAL CHARACTERISTICS	11
6.1 ABSOLUTE MAXIMUM RATING	11
6.2 DC ELECTRICAL CHARACTERISTICS.....	11
6.3 MIPI DC ELECTRICAL CHARACTERISTICS.....	12
6.4 LED BACKLIGHT CHARACTERISTICS.....	13
7. AC CHARACTERISTICS.....	15
7.1 MIPI INTERFACE CHARACTERISTICS:	15
7.1.1 High Speed Mode.....	15
7.1.2 Low Power Mode.....	16
7.1.3 Bursts Mode	17
7.2 RESET TIMING.....	19
8. LCD MODULE OUT-GOING QUALITY LEVEL	20
8.1 VISUAL & FUNCTION INSPECTION STANDARD	20
8.1.1 <i>Inspection conditions</i>	20
8.1.2 Definition.....	20
8.1.3 <i>Sampling Plan</i>	21
8.1.4 <i>Criteria (Visual)</i>	22
9. RELIABILITY TEST RESULT	25
10. CAUTIONS AND HANDLING PRECAUTIONS	26
10.1 HANDLING AND OPERATING THE MODULE.....	26
10.2 STORAGE AND TRANSPORTATION.....	26
11. PACKING	28

1. Description

This is a color active matrix TFT (Thin Film Transistor) LCD (liquid crystal display) that uses amorphous silicon TFT as a switching device. This module is composed of a Transmissive type TFT-LCD Panel, driver circuit, back-light unit. The resolution of a 2.35" TFT-LCD contains 320x480 pixels, and can display up to 16.7M colors.

1.1 Features

General Information Items	Specification	Unit	Note
	Main Panel		
Display area(AA)	33.12(H)*49.68(V) (2.35 inch)	mm	
Driver element	TFT active matrix	-	
Display colors	16.7M	colors	
Number of pixels	320(RGB)*480	dots	
Pixel arrangement	RGB tilt stripe	-	
Pixel pitch	0.0345(H)*0.1035(V)	mm	
Viewing angle	ALL	o'clock	
Controller IC	ST7701S	-	
LCM Interface	2-lane MIPI	-	
Display mode	Transmissive /Normally Black	-	
Operating temperature	-20~+70	°C	
Storage temperature	-30~+80	°C	

1.2 Mechanical Information

Item		Min.	Typ.	Max.	Unit	Note
Module size	Horizontal(H)	-	39.52	-	mm	
	Vertical(V)	-	60.68	-	mm	
	Depth(D)	-	2.26	-	mm	
Weight		-	10	-	g	

2. Block Diagram

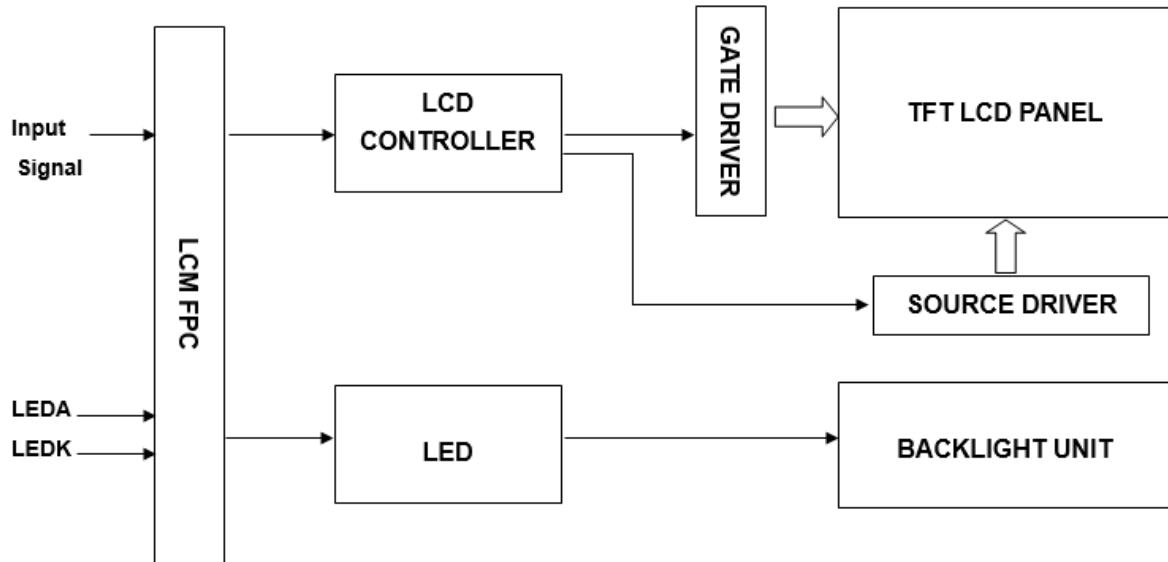

3. Outline dimension

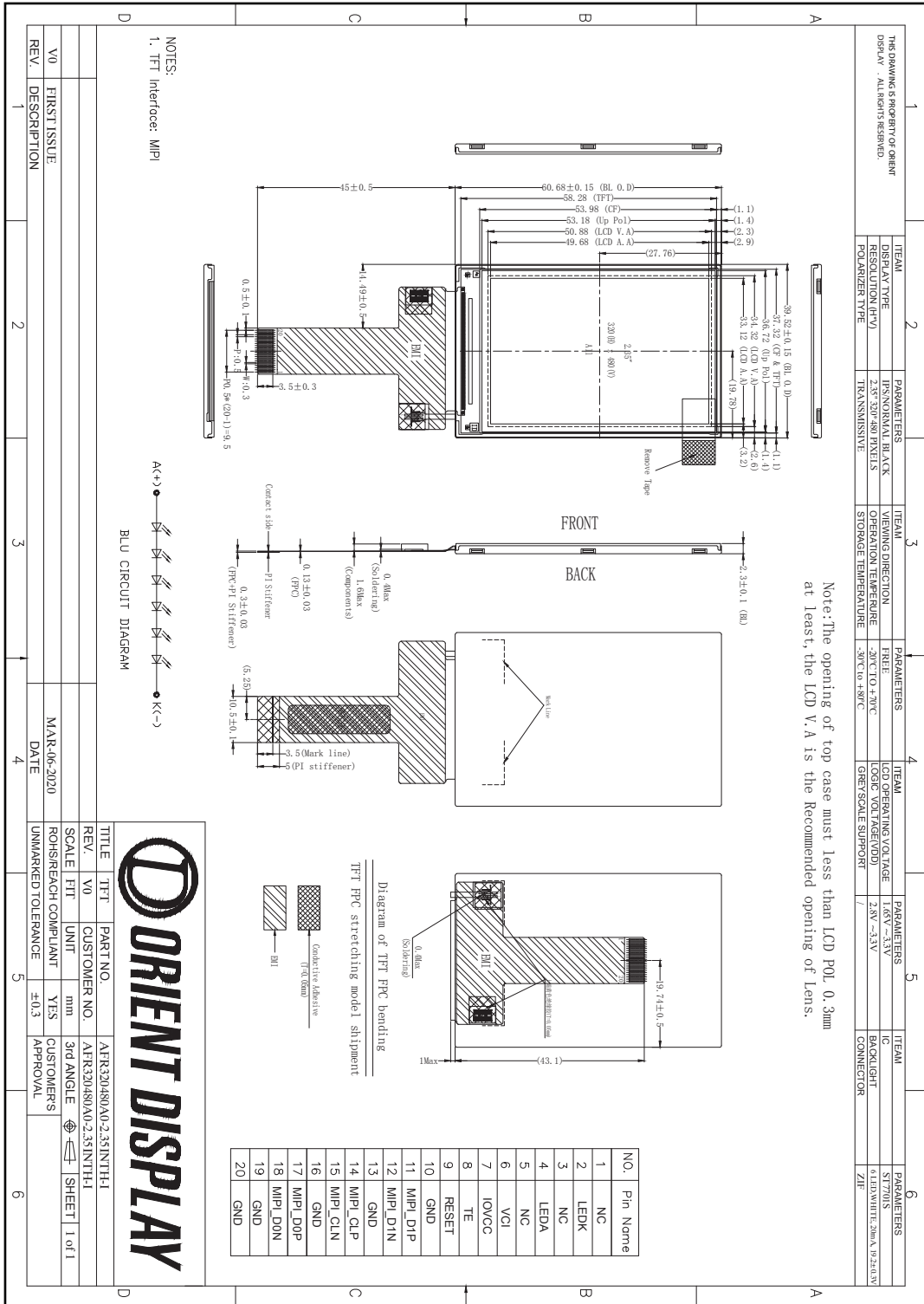

4. Input terminal Pin Assignment

NO.	SYMBOL	DISCRIPTION	I/O
1	NC	--	--
2	LEDK	Cathode pin of backlight.	P
3	NC	--	--
4	LEDA	Anode pin of backlight.	P
5	NC	--	--
6	VDD/VCI	Supply Voltage (3.3V).	P
7	IOVCC	I/O power supply voltage.	P
8	TE	-Tearing effect output Leave the pin to open when not in use.	O
9	RESET	- The external reset input. Initializes the chip with a low input. Be sure to execute a power-on reset after supplying power.	I
10	GND	Ground.	P
11	MIPI_D1P	MIPI DSI differential data pair (DSI-Dn+/-).	I/O
12	MIPI_D1N		I/O
13	GND	Ground.	P
14	MIPI_CLP	MIPI DSI differential clock pair (DSI-CLK+/-).	I
15	MIPI_CLN		I
16	GND	Ground.	P
17	MIPI_D0P	MIPI DSI differential data pair (DSI-Dn+/-).	I/O
18	MIPI_D0N		I/O
19	GND	Ground.	P
20	GND	Ground.	P

5. LCD Optical Characteristics

5.1 Optical specification

Item		Symbol	Condition	Min.	Typ.	Max.	Unit.	Note
Contrast Ratio		CR	$\Theta=0$ Normal viewing angle	600	800	--		(1)(2)
Response time	Rising	T_{R+T_F}		--	30	45	msec	(1)(3)
	Falling							
Color Gamut		S(%)		53	58	--	%	*
Color Filter Chromaticity	White	W_X		0.2559	0.2959	0.3359		(1)(4) CA-310
		W_Y		0.2801	0.3201	0.3601		
	Red	R_X		0.5849	0.6248	0.6648		
		R_Y		0.3184	0.3584	0.3984		
	Green	G_X		0.3072	0.3472	0.3872		
		G_Y		0.5248	0.5648	0.6048		
	Blue	B_X	0.1078	0.1478	0.1878			
		B_Y	0.0446	0.0846	0.1246			
Viewing angle	Hor.	Θ_L	CR>10	--	80	--	(1)(4)	
		Θ_R		--	80	--		
	Ver.	Θ_U		--	80	--		
		Θ_D		--	80	--		
Option View Direction		ALL						

*The data comes from the LCD specification.

Measuring Condition

Measuring surrounding : dark room

Ambient temperature : $25 \pm 2^\circ\text{C}$

15min. warm-up time.

Measuring Equipment

FPM520 of Westar Display technologies, INC., which utilized SR-3 for Chromaticity and BM-5A for other optical characteristics.

Note (1): Definition of Viewing Angle :

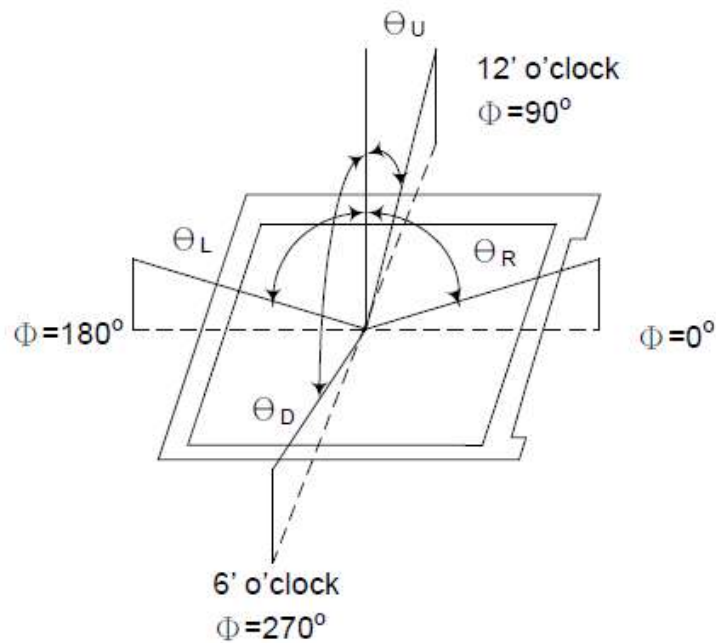

Note (2): Definition of Contrast Ratio(CR) :measured at the center point of panel

$$\text{CR} = \frac{\text{Luminance with all pixels white}}{\text{Luminance with all pixels black}}$$

Note (3): Response Time

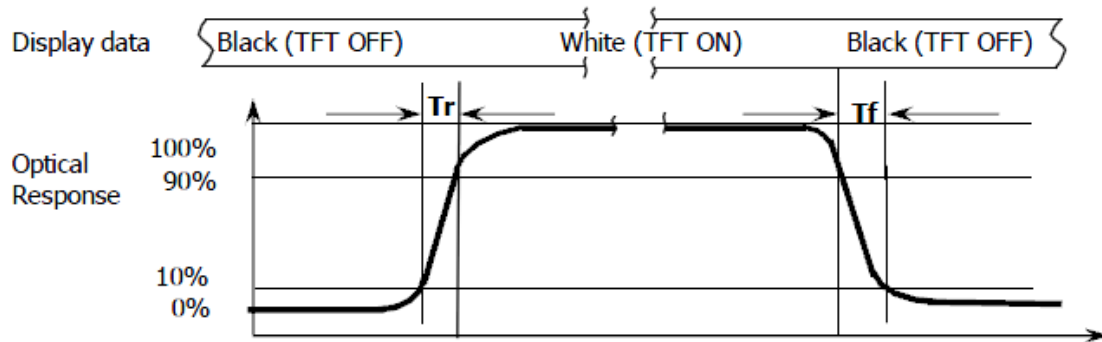

Note (4): Definition of optical measurement setup

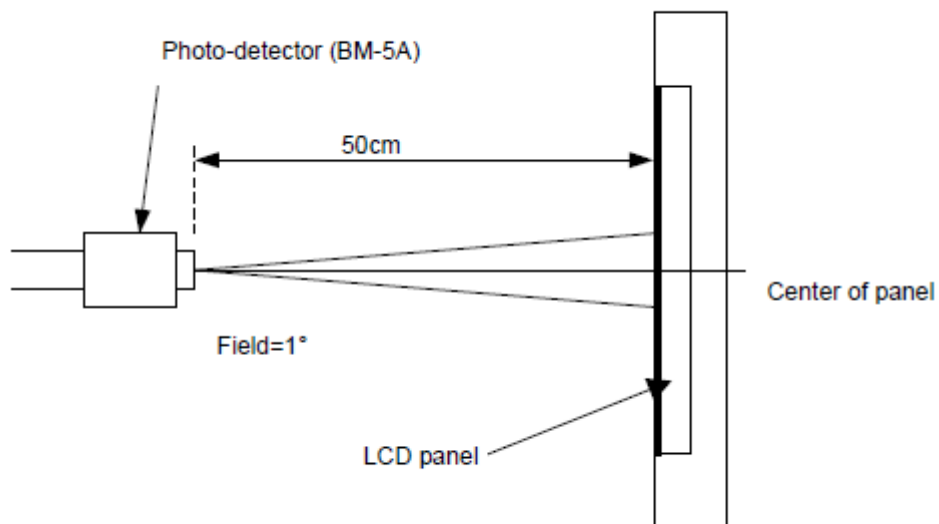

6. Electrical Characteristics

6.1 Absolute Maximum Rating

Characteristics	Symbol	Min.	Max.	Unit	Note
Digital Supply Voltage	VCI	-0.3	4.6	V	Note1
Digital Interface Supply	IOVCC	-0.3	4.6	V	
Operating temperature	T _{OP}	-20	+70	°C	
Storage temperature	T _{ST}	-30	+80	°C	

NOTE1: If the absolute maximum rating of even is one of the above parameters is exceeded even momentarily,

the quality of the product may be degraded. Absolute maximum ratings, therefore, specify the values

exceeding which the product may be physically damaged. Be sure to use the product within the range

of the absolute maximum ratings.

6.2 DC Electrical Characteristics

Characteristics	Symbol	Min.	Typ.	Max.	Unit	Note
Digital Supply Voltage	VCI	2.5	3.3	3.6	V	
Digital interface supple	IOVCC	1.65	1.8	3.3	V	
Normal mode Current consumption	IDD	--	30	60	mA	
Differential Input High Threshold Voltage	VIT+	--	0	50	mV	MIPI_CLK MIPI_Data
Differential Input Low Threshold Voltage	VIT-	-50	0	--	mV	
Single-ended Receiver Input Operation Voltage Range	VIR	0.5	--	1.2	V	

6.3 MIPI DC Electrical Characteristics

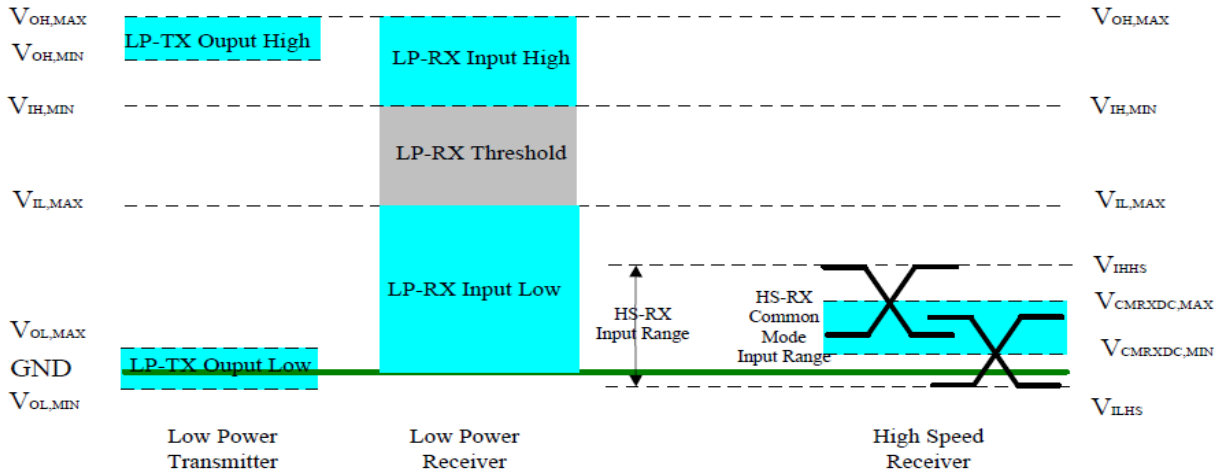

Parameter	Symbol	Specification			Unit
		MIN	TYP	MAX	
Operation Voltage for MIPI Receiver					
Low power mode operating voltage	V_{LPH}	1.1	1.2	1.3	V
MIPI Characteristics for High Speed Receiver					
Single-ended input low voltage	V_{ILHS}	-40	-	-	mV
Single-ended input high voltage	V_{IHHS}	-	-	460	mV
Common-mode voltage	$V_{CM,DC}$	70	-	330	mV
Differential input impedance	Z_{ID}	80	100	125	ohm
MIPI Characteristics for Low Power Mode					
Pad signal voltage range	V_I	-50	-	1350	mV
Logic 0 input threshold	V_{IL}	0-	-	550	mV
Logic 1 input threshold	V_{IH}	880	-	1350	mV
Output low level	V_{OL}	-50	-	50	mV
Output high level	V_{OH}	1.1	1.2	1.3	V

6.4 LED Backlight Characteristics

The back-light system is edge-lighting type with 6 chips LED

Item	Symbol	Min.	Typ.	Max.	Unit	Note
Forward Current	I_F	15	20	--	mA	
Forward Voltage	V_F	--	19.2	--	V	
LCM Luminance	LV	700	750	--	cd/m ²	Note3
LED life time	Hr	50000	--	--	Hour	Note1,2
Uniformity	Avg	80	--	--	%	Note3

Note1: LED life time (Hr) can be defined as the time in which it continues to operate under the condition:

$T_a=25\pm 3$ °C, typical IL value indicated in the above table until the brightness becomes less than 50%.

Note 2: The “LED life time” is defined as the module brightness decrease to 50% original brightness at $T_a=25^\circ\text{C}$ and $I_L=20\text{mA}$. The LED lifetime could be decreased if operating I_L is larger than 20mA. The constant current driving method is suggested.

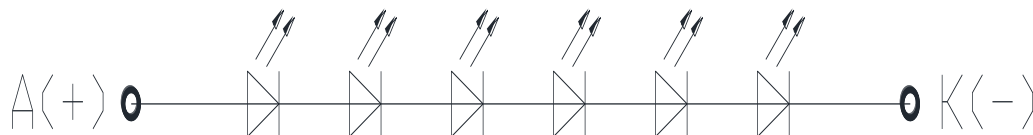

BLU CIRCUIT DIAGRAM

Note (3) Luminance Uniformity of these 9 points is defined as below:

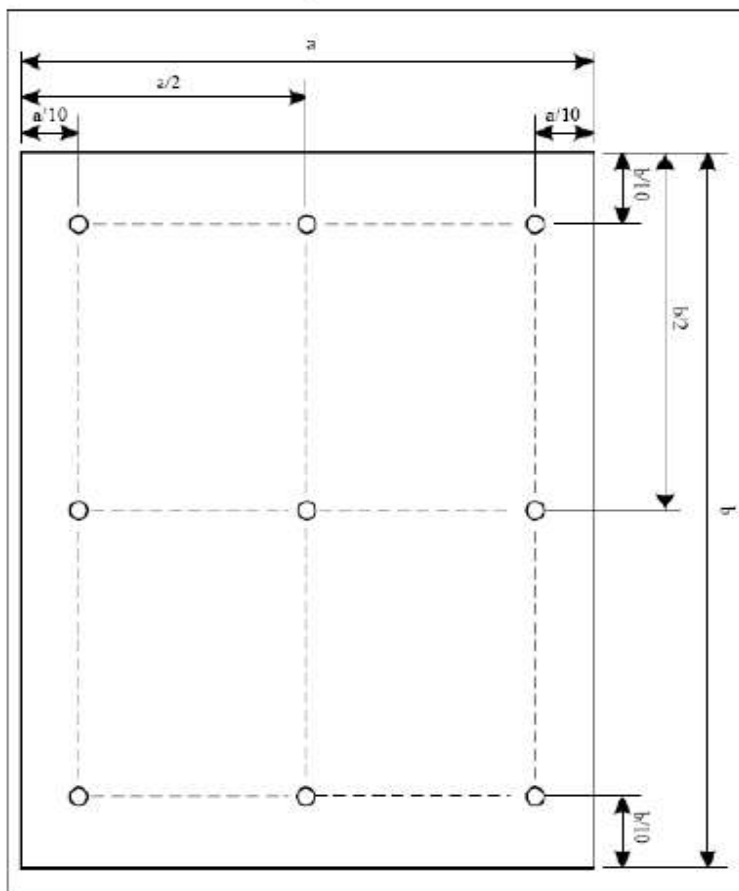

$$\text{Uniformity} = \frac{\text{minimum luminance in 9 points (1-9)}}{\text{maximum luminance in 9 points (1-9)}}$$

$$\text{Luminance} = \frac{\text{Total Luminance of 9 points}}{9}$$

7. AC Characteristics

7.1 MIPI Interface Characteristics:

7.1.1 High Speed Mode



***DSI clock channel timing**

Signal	Symbol	Parameter	MIN	MAX	Unit	Description
DSI-CLK+/-	$2xU_{INSTA}$	Double UI instantaneous	4	25	ns	
DSI-CLK+/-	U_{INSTA} U_{INSTB}	UI instantaneous halves	2	12.5	ns	$UI = U_{INSTA} = U_{INSTB}$
DSI-Dn+/-	t_{DS}	Data to clock setup time	0.15	-	UI	
DSI-Dn+/-	t_{DH}	Data to clock hold time	0.15	-	UI	

*** Mipi Interface-High SpeedMode Timing Characteristics**

7.1.2 Low Power Mode

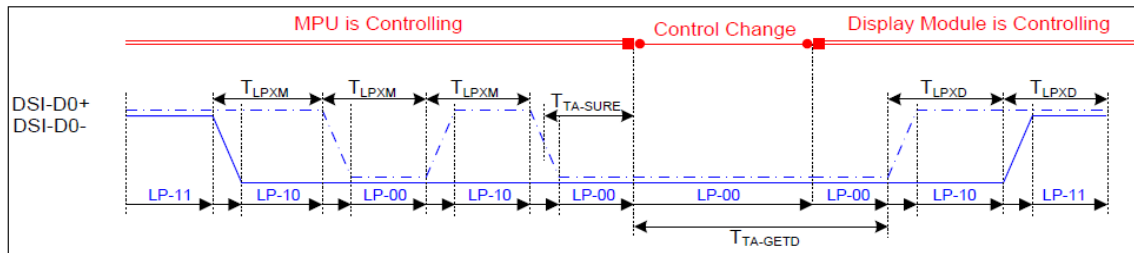

* Bus Turnaround (BTA) from display module to MPU Timing

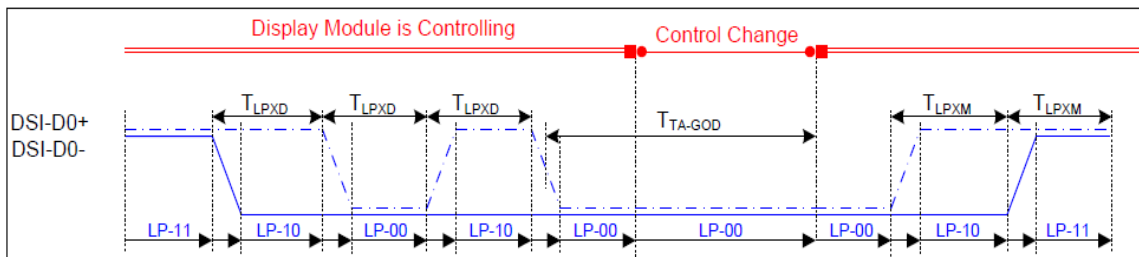

*Bus Turnaround (BTA) from MPU to display module Timing

Signal	Symbol	Parameter	MIN	MAX	Unit	Description
DSI-D0+/-	TLPXM	Length of LP-00,LP-01, LP-10 or LP-11 periods MPU→Display Module	50	75	ns	Input
DSI-D0+/-	TLPXD	Length of LP-00,LP-01, LP-10 or LP-11 periods MPU→Display Module	50	75	ns	Output
DSI-D0+/-	TTA-SURED	Time-out before the MPU start driving	T_{LPXD}	$2 \times T_{LPXD}$	ns	Output
DSI-D0+/-	TTA-GETD	Time to drive LP-00 by display module	$5 \times T_{LPXD}$		ns	Input
DSI-D0+/-	TTA-GOD	Time to drive LP-00 after turnaround request-MPU	$4 \times T_{LPXD}$		ns	Output

*Mipi Interface Low Power Mode Timing Characteristics

7.1.3 Bursts Mode

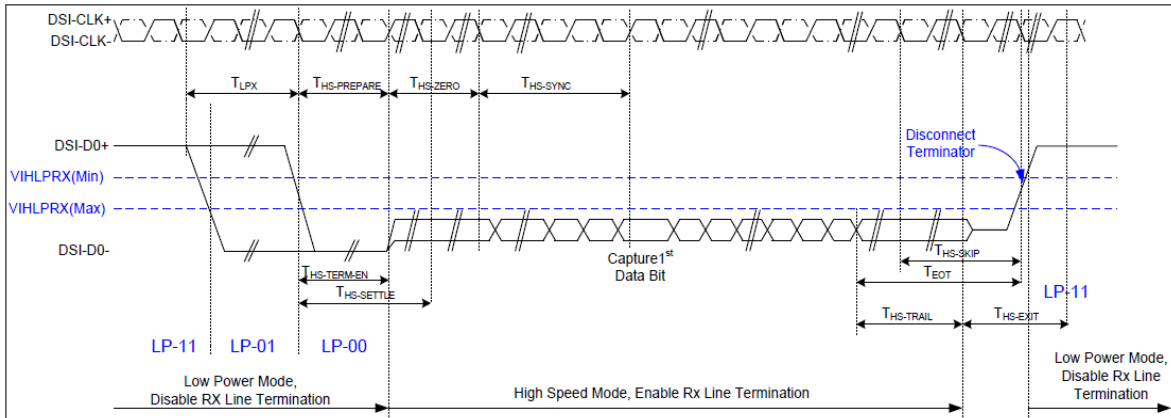

***Data lanes-Low Power Mode to/from High Speed Mode Timing**

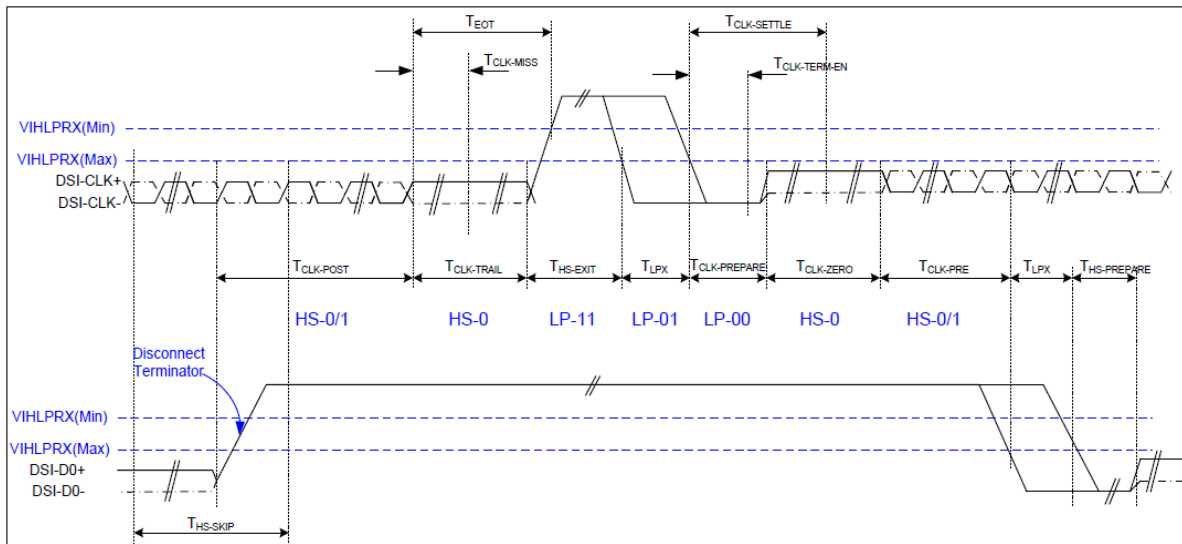

***Clock lanes- High Speed Mode to/from Low Power Mode Timing**

Signal	Symbol	Parameter	MIN	MAX	Unit	Description
Low Power Mode to High Speed Mode Timing						
DSI-Dn+/-	TLPX	Length of any low power state period	50	-	ns	Input
DSI-Dn+/-	THS-PREPARE	Time to drive LP-00 to prepare for HS transmission	40+4 UI	85+6 UI	ns	Input
DSI-Dn+/-	THS-TERM-EN	Time to enable data receiver line termination measured from when Dn crosses VILMAX	-	35+4 UI	ns	Input
DSI-Dn+/-	THS-PREPARE + THS-ZERO	THS-PREPARE + time to drive HS-0 before the sync sequence	140+ 10UI	-	ns	Input
High Speed Mode to Low Power Mode Timing						
DSI-Dn+/-	THS-SKIP	Time-out at display module to ignore transition period of EoT	40	55+4 UI	ns	Input
DSI-Dn+/-	THS-EXIT	Time to drive LP-11 after HS burst	100	-	ns	Input
DSI-Dn+/-	THS-TRAIL	Time to drive flipped differential state after last payload data bit of a HS transmission burst	60+4 UI	-	ns	Input
High Speed Mode to/from Low Power Mode Timing						
DSI-CLK+/-	TCLK-POS	Time that the MPU shall continue sending HS clock after the last associated data lane has transition to LP mode	60+5 2UI	-	ns	Input
DSI-CLK+/-	TCLK-TRAIL	Time to drive HS differential state after last payload clock bit of a HS transmission burst	60	-	ns	Input
DSI-CLK+/-	THS-EXIT	Time to drive LP-11 after HS burst	100	-	ns	Input
DSI-CLK+/-	TCLK-PREPARE	Time to drive LP-00 to prepare for HS transmission	38	95	ns	Input
DSI-CLK+/-	TCLK-TERM-EN	Time-out at clock lan display module to enable HS transmission	--	38	ns	Input
DSI-CLK+/-	TCLK-PREPARE + TCLK-ZERO	Minimum lead HS-0 drive period before starting clock	300	-	ns	Input
DSI-CLK+/-	TCLK-PRE	Time that the HS clock shall be driven prior to any associated data lane beginning the transition from LP to HS mode	8UI	-	ns	Input
DSI-CLK+/-	TEOT	Time form start of TCLK-TRAIL period to start of LP-11 state	-	105n s+12 UI	ns	Input

7.2 Reset timing

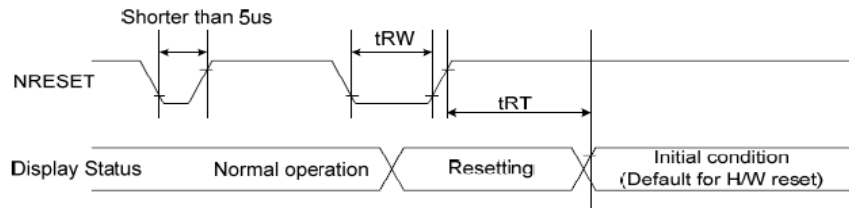

Figure 102 Reset Timing

Table 41 Reset Timing

Signal	Symbol	Parameter	Min	Max	Unit
RESX	tRW	Reset pulse duration	10		us
	tRT	Reset cancel		5(note 1,5) 120 (note 1,6,7)	ms

Note:

1. The reset cancel includes also required time for loading ID bytes, VCOM setting and other settings from OTP to registers. This loading is done every time when there is H/W reset cancel time (tRT) within 5 ms after a rising edge of RESX.
2. Spike due to an electrostatic discharge on RESX line does not cause irregular system reset according to the Table 43.

Table 42 Reset Descript

RESX Pulse	Action
Shorter than 5us	Reset Rejected
Longer than 9us	Reset
Between 5us and 9us	Reset starts

3. During the Resetting period, the display will be blanked (The display is entering blanking sequence, which maximum time is 120 ms, when Reset Starts in Sleep Out mode. The display remains the blank state in Sleep In mode.) and then return to Default condition for Hardware Reset.
4. Spike Rejection also applies during a valid reset pulse as shown below:

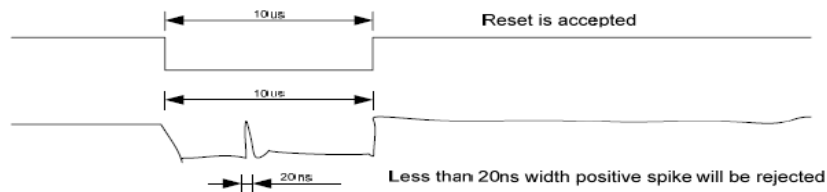

Figure 103 Positive Noise Pulse during Reset Low

5. When Reset applied during Sleep In Mode.
6. When Reset applied during Sleep Out Mode.
7. It is necessary to wait 5msec after releasing RESX before sending commands. Also Sleep Out command cannot be sent for 120msec.

8. LCD Module Out-Going Quality Level

8.1 VISUAL & FUNCTION INSPECTION STANDARD

8.1.1 Inspection conditions

Inspection performed under the following conditions is recommended.

Temperature : $25\pm 5^{\circ}\text{C}$

Humidity : $65\%\pm 10\%\text{RH}$

Viewing Angle : Normal viewing Angle.

Illumination: Single fluorescent lamp (300 to 700Lux)

Viewing distance:30-50cm

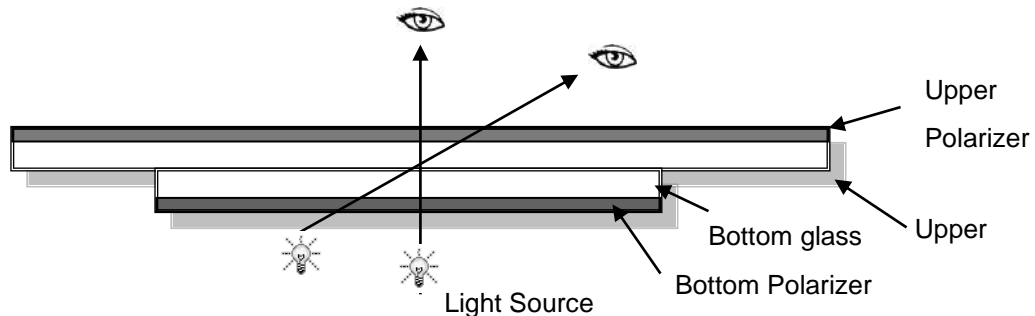

8.1.2 Definition

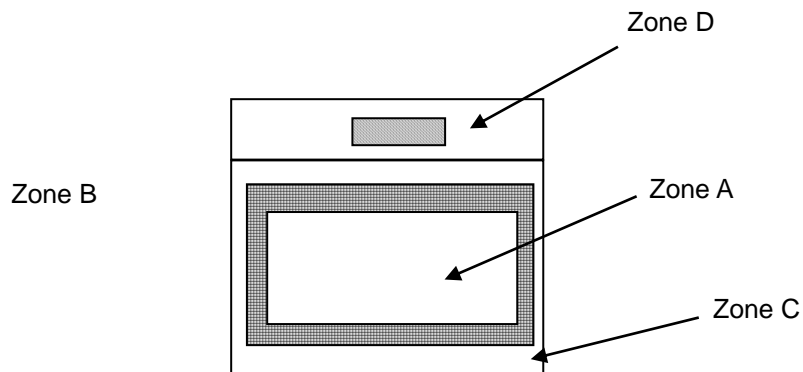

Zone A : Effective Viewing Area(Character or Digit can be seen)

Zone B : Viewing Area except Zone A

Zone C : Outside (Zone A+Zone B) which can not be seen after assembly by customer .)

Zone D : IC Bonding Area

Note:As a general rule ,visual defects in Zone C can be ignored when it doesn't effect product function or appearance after assembly by customer

8.1.3 Sampling Plan

According to GB/T 2828.1-2003 ; , normal inspection, Class II

AQL:

Major defect	Minor defect
0.65	1.5

LCD: Liquid Crystal Display , TP: Touch Panel , LCM: Liquid Crystal Module

No	Items to be inspected	Criteria	Classification of defects
1	Functional defects	1) No display, Open or miss line 2) Display abnormally, Short 3) Backlight no lighting, abnormal lighting. 4) TP no function	Major
2	Missing	Missing component	
3	Outline dimension	Overall outline dimension beyond the drawing is not allowed	
4	Color tone	Color unevenness, refer to limited sample	Minor
5	Spot Line defect	Light dot, Dim spot, Polarizer Bubble ; Polarizer accidented spot.	
6	Soldering appearance	Good soldering , Peeling off is not allowed.	
7	LCD/Polarizer/TP	Black/White spot/line, scratch, crack, etc.	

8.1.4 Criteria (Visual)

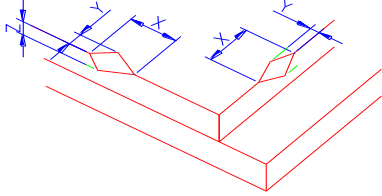
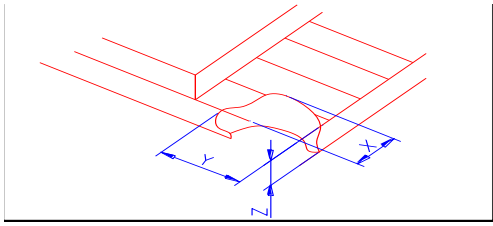
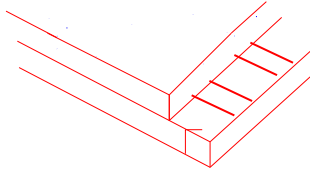
Number	Items	Criteria(mm)						
1.0 LCD Crack/Broken NOTE: X: Length Y: Width Z: Height L: Length of ITO, T: Height of LCD	(1) The edge of LCD broken	 <table border="1" data-bbox="746 647 1401 795"> <thead> <tr> <th>X</th> <th>Y</th> <th>Z</th> </tr> </thead> <tbody> <tr> <td>≤3.0mm</td> <td><Inner border line of the seal</td> <td>≤T</td> </tr> </tbody> </table>	X	Y	Z	≤3.0mm	<Inner border line of the seal	≤T
	X	Y	Z					
	≤3.0mm	<Inner border line of the seal	≤T					
(2) LCD corner broken	 <table border="1" data-bbox="802 1104 1345 1205"> <thead> <tr> <th>X</th> <th>Y</th> <th>Z</th> </tr> </thead> <tbody> <tr> <td>≤3.0mm</td> <td>≤L</td> <td>≤T</td> </tr> </tbody> </table>	X	Y	Z	≤3.0mm	≤L	≤T	
X	Y	Z						
≤3.0mm	≤L	≤T						
(3) LCD crack	 <p style="text-align: center;">Crack Not allowed</p>							

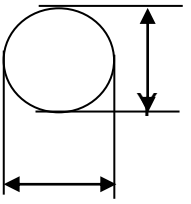
2.0	<p>Spot defect</p>  <p>$\Phi=(X+Y)/2$</p>	<p>① light dot (LCD/TP/Polarizer black/white spot , light dot, pinhole, dent, stain)</p> <table border="1"> <thead> <tr> <th rowspan="2">Zone Size (mm)</th> <th colspan="3">Acceptable Qty</th> </tr> <tr> <th>A</th> <th>B</th> <th>C</th> </tr> </thead> <tbody> <tr> <td>$\Phi \leq 0.10$</td> <td colspan="3">Ignore</td> </tr> <tr> <td>$0.10 < \Phi \leq 0.25$</td> <td colspan="3">3(distance $\geq 10\text{mm}$)</td> </tr> <tr> <td>$0.25 < \Phi \leq 0.3$</td> <td colspan="3">2</td> </tr> <tr> <td>$\Phi > 0.35$</td> <td colspan="3">0</td> </tr> </tbody> </table>	Zone Size (mm)	Acceptable Qty			A	B	C	$\Phi \leq 0.10$	Ignore			$0.10 < \Phi \leq 0.25$	3(distance $\geq 10\text{mm}$)			$0.25 < \Phi \leq 0.3$	2			$\Phi > 0.35$	0		
		Zone Size (mm)		Acceptable Qty																					
			A	B	C																				
		$\Phi \leq 0.10$	Ignore																						
		$0.10 < \Phi \leq 0.25$	3(distance $\geq 10\text{mm}$)																						
$0.25 < \Phi \leq 0.3$	2																								
$\Phi > 0.35$	0																								
<p>② Dim spot (LCD/TP/Polarizer dim dot, light leakage, dark spot)</p> <table border="1"> <thead> <tr> <th rowspan="2">Zone Size (mm)</th> <th colspan="3">Acceptable Qty</th> </tr> <tr> <th>A</th> <th>B</th> <th>C</th> </tr> </thead> <tbody> <tr> <td>$\Phi \leq 0.1$</td> <td colspan="3">Ignore</td> </tr> <tr> <td>$0.10 < \Phi \leq 0.25$</td> <td colspan="3">3(distance $\geq 10\text{mm}$)</td> </tr> <tr> <td>$0.25 < \Phi \leq 0.3$</td> <td colspan="3">2</td> </tr> <tr> <td>$\Phi > 0.35$</td> <td colspan="3">0</td> </tr> </tbody> </table>	Zone Size (mm)	Acceptable Qty			A	B	C	$\Phi \leq 0.1$	Ignore			$0.10 < \Phi \leq 0.25$	3(distance $\geq 10\text{mm}$)			$0.25 < \Phi \leq 0.3$	2			$\Phi > 0.35$	0				
Zone Size (mm)		Acceptable Qty																							
	A	B	C																						
$\Phi \leq 0.1$	Ignore																								
$0.10 < \Phi \leq 0.25$	3(distance $\geq 10\text{mm}$)																								
$0.25 < \Phi \leq 0.3$	2																								
$\Phi > 0.35$	0																								
<p>③ Polarizer accidented spot</p> <table border="1"> <thead> <tr> <th rowspan="2">Zone Size (mm)</th> <th colspan="3">Acceptable Qty</th> </tr> <tr> <th>A</th> <th>B</th> <th>C</th> </tr> </thead> <tbody> <tr> <td>$\Phi \leq 0.2$</td> <td colspan="3">Ignore</td> </tr> <tr> <td>$0.3 < \Phi \leq 0.5$</td> <td colspan="3">2(distance $\geq 10\text{mm}$)</td> </tr> <tr> <td>$\Phi > 0.5$</td> <td colspan="3">0</td> </tr> </tbody> </table>	Zone Size (mm)	Acceptable Qty			A	B	C	$\Phi \leq 0.2$	Ignore			$0.3 < \Phi \leq 0.5$	2(distance $\geq 10\text{mm}$)			$\Phi > 0.5$	0								
Zone Size (mm)		Acceptable Qty																							
	A	B	C																						
$\Phi \leq 0.2$	Ignore																								
$0.3 < \Phi \leq 0.5$	2(distance $\geq 10\text{mm}$)																								
$\Phi > 0.5$	0																								
<p>④ Pixel bad points (light dot, Dim dot, color dot)</p> <table border="1"> <thead> <tr> <th rowspan="2">Zone Size (mm)</th> <th colspan="3">Acceptable Qty</th> </tr> <tr> <th>A</th> <th>B</th> <th>C</th> </tr> </thead> <tbody> <tr> <td>$\Phi \leq 0.1$</td> <td colspan="3">Ignore</td> </tr> <tr> <td>$0.15 < \Phi \leq 0.25$</td> <td colspan="3">2(distance \geq</td> </tr> <tr> <td>$\Phi > 0.3$</td> <td colspan="3">0</td> </tr> </tbody> </table>	Zone Size (mm)	Acceptable Qty			A	B	C	$\Phi \leq 0.1$	Ignore			$0.15 < \Phi \leq 0.25$	2(distance \geq			$\Phi > 0.3$	0								
Zone Size (mm)		Acceptable Qty																							
	A	B	C																						
$\Phi \leq 0.1$	Ignore																								
$0.15 < \Phi \leq 0.25$	2(distance \geq																								
$\Phi > 0.3$	0																								
<p>⑤ Polarizer Bubble</p> <table border="1"> <thead> <tr> <th rowspan="2">Zone Size (mm)</th> <th colspan="3">Acceptable Qty</th> </tr> <tr> <th>A</th> <th>B</th> <th>C</th> </tr> </thead> <tbody> <tr> <td>$\Phi \leq 0.2$</td> <td colspan="3">Ignore</td> </tr> <tr> <td>$0.3 < \Phi \leq 0.4$</td> <td colspan="3">3(distance $\geq 10\text{mm}$)</td> </tr> <tr> <td>$0.4 < \Phi \leq 0.5$</td> <td colspan="3">2</td> </tr> <tr> <td>$\Phi > 0.5$</td> <td colspan="3">0</td> </tr> </tbody> </table>	Zone Size (mm)	Acceptable Qty			A	B	C	$\Phi \leq 0.2$	Ignore			$0.3 < \Phi \leq 0.4$	3(distance $\geq 10\text{mm}$)			$0.4 < \Phi \leq 0.5$	2			$\Phi > 0.5$	0				
Zone Size (mm)		Acceptable Qty																							
	A	B	C																						
$\Phi \leq 0.2$	Ignore																								
$0.3 < \Phi \leq 0.4$	3(distance $\geq 10\text{mm}$)																								
$0.4 < \Phi \leq 0.5$	2																								
$\Phi > 0.5$	0																								

3.0	Line defect (LCD/TP /Polarizer backlight black/white line, scratch, stain)	Width(mm)	Length(mm)	Acceptable Qty		
				A	B	C
		$\Phi \leq 0.05$	Ignore	Ignore		
		$0.05 < W \leq 0.06$	$L \leq 3.0$	N \leq 2		
		$0.07 < W \leq 0.08$	$L \leq 2.0$	N \leq 1		
	$0.08 < W$	Define as spot defect				
4.0	Electronic Components SMT	Not allow missing parts, solderless connection, cold solder joint, mismatch, The positive and negative polarity opposite				
5.0	Display color & Brightness	1. Color: Measuring the color coordinates, The measurement standard according to the datasheet or samples. 2. Brightness: Measuring the brightness of White screen, The measurement standard according to the datasheet or Samples.				
6.0	LCD Mura	By 5% ND filter invisible.				

Criteria (functional items)

Number	Items	Criteria (mm)
1	No display	Not allowed
2	Missing segment	Not allowed
3	Short	Not allowed
4	Backlight no lighting	Not allowed
5	TP no function	Not allowed

9. Reliability Test Result

Item	Condition	Inspection after test
High Temperature	70°C,96H	Inspection after 2~4hours storage at room temperature, the sample shall be free from defects: 1.Air bubble in the LCD; 2.Non-display; 3.Missing segments/line; 4.Glass crack; 5.Current IDD is twice higher than initial value.
Low Temperature	-20°C, 96HR	
High Temperature	80°C, 96HR	
Low Temperature Storage	-30°C, 96HR	
High Temperature & High Humidity Operating	+60°C, 90% RH ,96 hours.	
Thermal Shock (Non-operation)	-10°C,30 min ↔ +60°C,30 min, Change time:5min 20CYC.	
ESD test	C=150pF, R=330,5points/panel Air:±8KV, 5times; Contact:±6KV, 5 times; (Environment: 15°C~35°C, 30%~60%).	
Vibration (Non-operation)	Frequency range:10~55Hz, Stroke:1.5mm Sweep:10Hz~55Hz~10Hz 2 hours for each direction of X.Y.Z. (6 hours for total)	
Box Drop Test	1 Corner 3 Edges 6 faces,80cm(MEDIUM	

Remark:

- 1.The test samples should be applied to only one test item.
- 2.Sample size for each test item is 5~10pcs.
- 3.For Damp Proof Test, Pure water(Resistance > 10MΩ) should be used.
- 4.In case of malfunction defect caused by ESD damage, if it would be recovered to normal state after resetting, it would be judged as a good part.
- 5.Failure Judgment Criterion: Basic Specification, Electrical Characteristic, Mechanical Characteristic, Optical Characteristic.
6. The color fading mura of polarizing filter should not care.

10. Cautions and Handling Precautions

10.1 Handling and Operating the Module

- (1) When the module is assembled, it should be attached to the system firmly.
Do not warp or twist the module during assembly work.
- (2) Protect the module from physical shock or any force. In addition to damage, this may cause improper operation or damage to the module and back-light unit.
- (3) Note that polarizer is very fragile and could be easily damaged. Do not press or scratch the surface.
- (4) Do not allow drops of water or chemicals to remain on the display surface.
If you have the droplets for a long time, staining and discoloration may occur.
- (5) If the surface of the polarizer is dirty, clean it using some absorbent cotton or soft cloth.
- (6) The desirable cleaners are water, IPA (Isopropyl Alcohol) or Hexane.
Do not use ketene type materials (ex. Acetone), Ethyl alcohol, Toluene, Ethyl acid or Methyl chloride.
It might permanent damage to the polarizer due to chemical reaction.
- (7) If the liquid crystal material leaks from the panel, it should be kept away from the eyes or mouth. In case of contact with hands, legs, or clothes, it must be washed away thoroughly with soap.
- (8) Protect the module from static; it may cause damage to the CMOS ICs.
- (9) Use finger-stalls with soft gloves in order to keep display clean during the incoming inspection and assembly process.
- (10) Do not disassemble the module.
- (11) Protection film for polarizer on the module shall be slowly peeled off just before use so that the electrostatic charge can be minimized.
- (12) Pins of I/F connector shall not be touched directly with bare hands.
- (13) Do not connect, disconnect the module in the "Power ON" condition.
- (14) Power supply should always be turned on/off by the item 6.1 Power On Sequence & 6.2 Power Off Sequence

10.2 Storage and Transportation.

- (1) Do not leave the panel in high temperature, and high humidity for a long time.
It is highly recommended to store the module with temperature from 0 to 35 °C and relative humidity of less than 70%
- (2) Do not store the TFT-LCD module in direct sunlight.
- (3) The module shall be stored in a dark place. When storing the modules for a long time, be sure to adopt effective measures for protecting the modules from strong ultraviolet radiation, sunlight, or fluorescent light.
- (4) It is recommended that the modules should be stored under a condition where no condensation is allowed. Formation of dewdrops may cause an abnormal operation or a failure of the module.

In particular, the greatest possible care should be taken to prevent any module from being operated where condensation has occurred inside.

(5) This panel has its circuitry FPC on the bottom side and should be handled carefully in order not to be stressed.

11. Packing

