



# ORIENT DISPLAY

Your Total LCD Solution Provider

## Specification for TFT

### AFY320240A0-3.5INTH

Revision A



A	Orient Display
FY	TFT Type
320240	Resolution 240 x 320
A0	Serial A0
3.5	3.5", Module Dimension 76.90 x 63.90 x 2.77mm
I	IPS Display
N	Top: -20~+70°C; Tstr: -30~+80°C
T	Transmissive
H	High Brightness, 1000 cd/m2
/	No Touch Panel
/	Controller <a href="#">ST7272A</a> Or Compatible
/	SPI+RGB Interface





## CONTENTS

<b>1. GENERAL INFORMATION .....</b>	<b>4</b>
<b>2. ABSOLUTE MAXIMUM RATINGS.....</b>	<b>4</b>
<b>3. ELECTRICAL CHARACTERISTICS.....</b>	<b>4</b>
<b>4. BACKLIGHT CHARACTERISTICS .....</b>	<b>4</b>
<b>5. EXTERNAL DIMENSIONS .....</b>	<b>5</b>
<b>6. ELECTRO-OPTICAL CHARACTERISTICS.....</b>	<b>6</b>
<b>7. INTERFACE DESCRIPTION.....</b>	<b>9</b>
<b>8. AC CHARACTERISTICS .....</b>	<b>10</b>
<b>9. POWER SEQUENCE.....</b>	<b>15</b>
<b>10. RELIABILITY TEST CONDITIONS.....</b>	<b>16</b>
<b>11. INSPECTION CRITERION .....</b>	<b>17</b>
<b>12. HANDLING PRECAUTIONS .....</b>	<b>25</b>
<b>13. PRECAUTION FOR USE.....</b>	<b>26</b>
<b>14. PACKING SPECIFICATION.....</b>	<b>26</b>

## 1. GENERAL INFORMATION

No.	Item	Contents	Unit
1	LCD size	3.5 inch (Diagonal)	/
2	LCD type	IPS/Normally black/Transmissive(Anti-glare)	/
3	Viewing direction(eye)	Free	/
4	Gray scale inversion direction	/	/
5	Resolution(H*V)	320*240 Pixels	/
6	Module size (L*W*H) (Exclude FPC)	76.90*63.90*2.77	mm
7	Active area (L*W)	70.08*52.56	mm
8	Pixel pitch (L*W)	0.219*0.219	mm
9	Interface type	SPI+RGB interface	/
10	Module power consumption	TBD	W
11	Back light type	LED	/
12	Driver IC	ST7272 OR COMPATIBLE	/
13	Weight	TBD	g

## 2. ABSOLUTE MAXIMUM RATINGS

Item	Symbol	Min.	Max.	Unit
Power supply input voltage(TFT Module)	VDD	-0.3	5.0	V
Backlight current (normal temp.)	ILED	-	50	mA
Operation temperature	Top	-20	+70	°C
Storage temperature	Tst	-30	+80	°C
Humidity	RH	-	90%(Max60 °C)	RH

## 3. ELECTRICAL CHARACTERISTICS

### DC CHARACTERISTICS(at Ta=25°C)

Item	Symbol	Min.	Typ.	Max.	Unit	Note
Power supply input voltage(TFT Module)	VDD	3.0	3.3	3.6	V	
I/O logic voltage	VDDIO	-	-	-	V	=VDD
Input voltage 'H' level	VIH	0.7VDDIO	-	VDDIO	V	
Input voltage 'L' level	VIL	VSS	-	0.3VDDIO	V	
Power supply current	IVDD	-	-	-	mA	
TFT gate on voltage	VGH	-	-	-	V	
TFT gate off voltage	VGL	-	-	-	V	
Analog power supply voltage	AVDD	-	-	-	V	
Differential input common mode voltage	Vcom	-	-	-	V	

## 4. BACKLIGHT CHARACTERISTICS

### (at Ta=25°C,RH=60%)

Item	Symbol	Min.	Typ.	Max.	Unit	Note
LED forward voltage	VF	17.4	18	19.2	V	
LED forward current	IF	-	40	-	mA	
LED power consumption	PLED	-	0.72	-	W	Note1
Number of LED	-		6		PCS	
Connection mode	-	3 in series 2 in parallel			/	
LED life-time	-	20000	-	-	Hrs	Note2

Note1 : Calculator value for reference :  $IF \cdot VF = PLED$

Note2 : The LED life-time define as the estimated time to 50% degradation of initial brightness at Ta=25°C and IF =40mA. The LED lifetime could be decreased if operating IF is larger than 40mA.

# 5. EXTERNAL DIMENSIONS

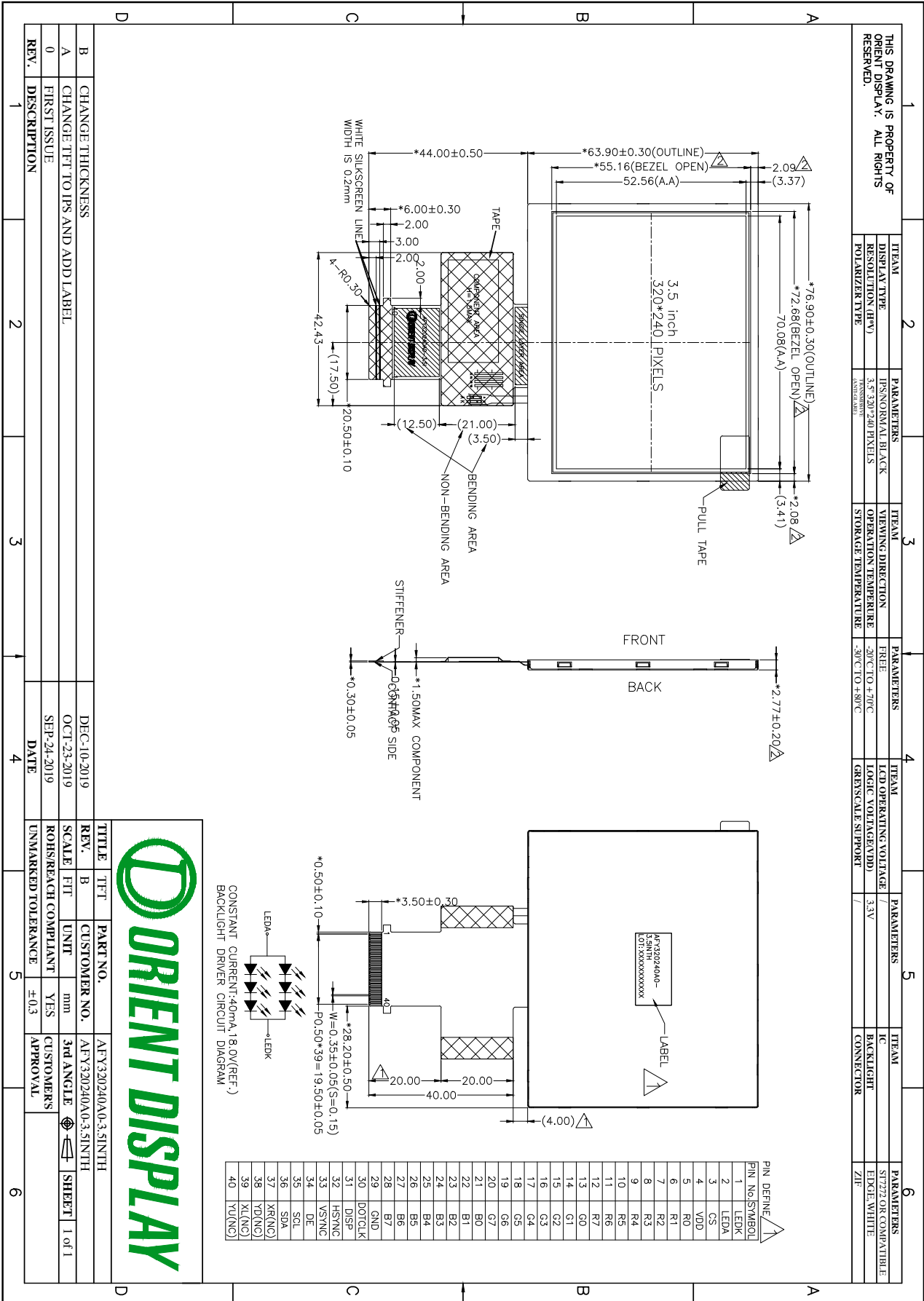

## 6. ELECTRO-OPTICAL CHARACTERISTICS

Item	Symbol	Condition	Min.	Typ.	Max.	Unit	Remark	Note
Response time	Tr+ Tf	-	-	30	40	ms	FIG.1	Note 4
Contrast ratio	Cr		640	800	-	-	FIG.2	Note 1
Surface luminance	Lv	$\theta=0^\circ$	800	1000	-	cd/m <sup>2</sup>	FIG.2	Note 2
Luminance uniformity	Yu	$\theta=0^\circ$	75	80	-	%	FIG.2	Note 3
NTSC	-	$\theta=0^\circ$	55	60	-	%	FIG.2	Note 5
Viewing angle	$\theta$	$\varnothing=90^\circ$	70	80	-	deg	FIG.3	Note 6
		$\varnothing=270^\circ$	70	80	-	deg	FIG.3	
		$\varnothing=0^\circ$	70	80	-	deg	FIG.3	
		$\varnothing=180^\circ$	70	80	-	deg	FIG.3	
CIE (x,y) chromaticity	Red x	$\theta=0^\circ$ $\varnothing=0^\circ$ $T_a=25^\circ\text{C}$	Typ -0.04	TBD	Typ +0.04	-	FIG.2 CIE1931	Note 5
	Red y			TBD		-		
	Green x			TBD		-		
	Green y			TBD		-		
	Blue x			TBD		-		
	Blue y			TBD		-		
	White x			TBD		-		
	White y			TBD		-		

### Note1. Definition of contrast ratio

Contrast ratio(Cr) is defined mathematically by the following formula.  
For more information see FIG.2.

$$\text{Contrast ratio} = \frac{\text{Luminance measured when LCD on the "White" state}}{\text{Luminance measured when LCD on the "Black" state}}$$

Measured at the center area of the LCD

### Note2. Definition of surface luminance

Surface luminance is the luminance with all pixels displaying white.  
For more information see FIG.2.

$$L_v = \text{Average Surface Luminance with all white pixels}(P_1, P_2, P_3, \dots, P_n)$$

### Note3. Definition of luminance uniformity

The luminance uniformity in surface luminance is determined by measuring luminance at each test position 1 through n, and then dividing the maximum luminance of n points luminance by minimum luminance of n points luminance. For more information see FIG.2.

$$Y_u = \frac{\text{Minimum surface luminance with all white pixels } (P_1, P_2, P_3, \dots, P_n)}{\text{Maximum surface luminance with all white pixels } (P_1, P_2, P_3, \dots, P_n)}$$

### Note4. Definition of response time

The response time is defined as the LCD optical switching time interval between "White" state and "Black" state. Rise time ( $T_{ON}$ ) is the time between photo detector output intensity changed from 90% to 10%. And fall time ( $T_{OFF}$ ) is the time between photo detector output intensity changed from 10% to 90%.  
For additional information see FIG1.

### Note5. Definition of color chromaticity (CIE1931)

CIE (x,y) chromaticity, The x,y value is determined by screen active area center position P5. For more information see FIG.2.

### Note6. Definition of viewing angle

Viewing angle is the angle at which the contrast ratio is greater than 10. angles are determined for the horizontal or x axis and the vertical or y axis with respect to the z axis which is normal to the LCD surface.  
For more information see FIG.3.

For viewing angle and response time testing, the testing data is base on Autronic-Melchers's ConoScope or DMS series Instruments or compatible. For contrast ratio, Surface Luminance, Luminance uniformity and CIE, the testing data is base on TOPCON's BM-5 or BM-7 photo detector or compatible.

**FIG.1. The definition of response Time**

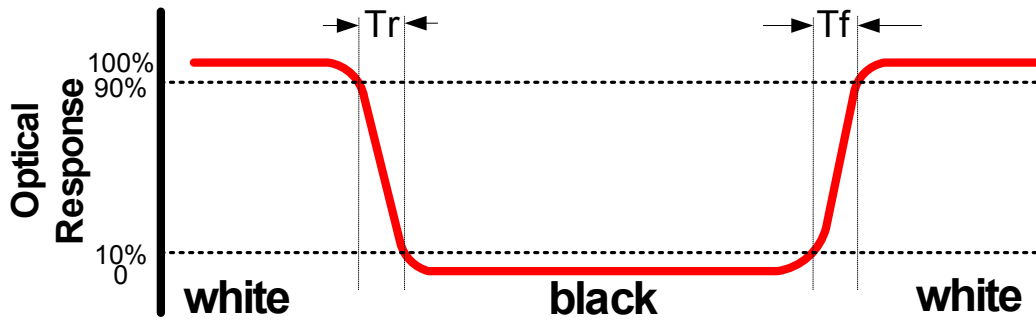

**FIG.2. Measuring method for contrast ratio, surface luminance, luminance uniformity, CIE (x,y) chromaticity**

Size :  $S \leq 5"$  (see Figure a)

A : 5 mm B : 5 mm

H,V : Active area

Light spot size  $\varnothing = 5\text{mm}$  (BM-5) or  $\varnothing = 7.7\text{mm}$  (BM-7) 50cm distance or compatible distance from the LCD surface to detector lens.

test spot position : see Figure a.

measurement instrument : TOPCON's luminance meter BM-5 or BM-7 or compatible (see Figure c).

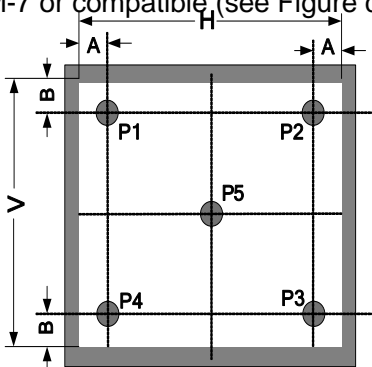

Figure a

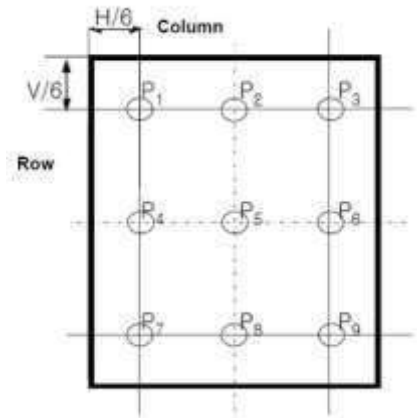

Figure b

Size :  $5" < S \leq 12.3"$  (see Figure b)

H,V : Active area

Light spot size  $\varnothing = 5\text{mm}$  (BM-5) or  $\varnothing = 7.7\text{mm}$  (BM-7) 50cm distance or compatible distance from the LCD surface to detector lens.

test spot position : see Figure b.

measurement instrument : TOPCON's luminance meter BM-5 or BM-7 or compatible (see Figure c).

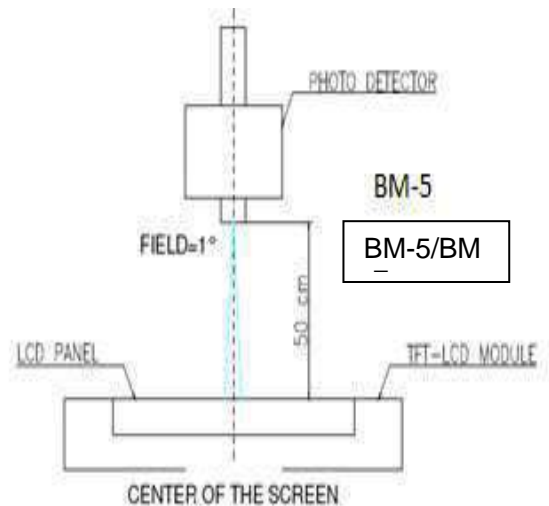
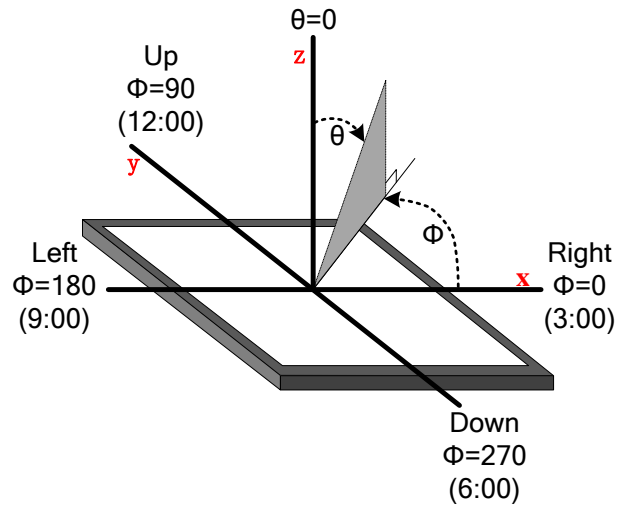

Figure c

**FIG.3. The definition of viewing angle**





## 7. INTERFACE DESCRIPTION

### TFT Module Interface description

Interface No.	Name	I/O or connect to	Description
1	LEDK	P	Power for LED backlight(Cathode)
2	LEDA	P	Power for LED backlight(Anode)
3	CS	I	SPI-3 chip selected signal
4	VDD	P	Power Supply
5-12	R0-R7	I/O	Red data bus
13-20	G0-G7	I/O	Green data bus
21-28	B0-B7	I/O	Blue data bus
29	GND	P	Power Ground
30	DOTCLK	I	Dot clock
31	DISP	I	Display Mode DISP=0: Standby Mode DISP=1: Normal Display Mode
32	HAYNC	I	Horizontal sync signal.
33	VSYNC	I	Vertical sync signal.
34	DE	I	Data enable.
35	SCL	I	SPI-3 clock input signal
36	SDA	I	SPI-3 data signal
37	XR (NC)	/	X-Right
38	YD (NC)	/	Y-Down
39	XL (NC)	/	X-Left
40	YU(NC)	/	Y-Up

## 8. AC CHARACTERISTICS

### 8.1. 3-wire Serial Interface

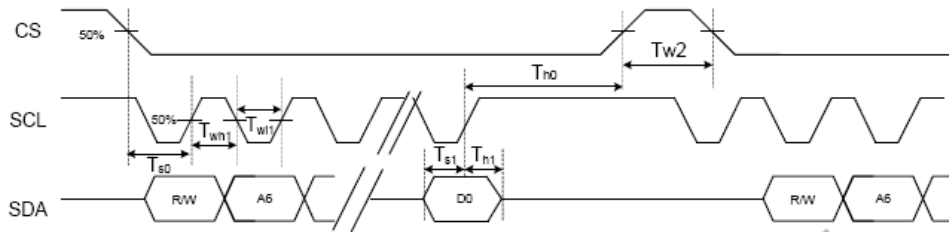

Item	Symbol	Min.	Typ.	Max.	Unit	Conditions
CS Input Setup Time	Ts0	50	-	-	ns	
Serial Data Input Setup Time	Ts1	50	-	-	ns	
CS Input Hold Time	Th0	50	-	-	ns	
Serial Data Input Hold Time	Th1	50	-	-	ns	
SCL Write Pulse High Width	Twh1	50	-	-	ns	
SCL Write Pulse Low Width	Tw1	50	-	-	ns	
SCL Read Pulse High Width	Trh1	300			ns	
SCL Read Pulse Low Width	Trl1	300			ns	
CS Pulse High Width	Tw2	400	-	-	ns	

R/W: Read/Write mode control bit.  
R/W=1: Read mode  
R/W=0: Write mode

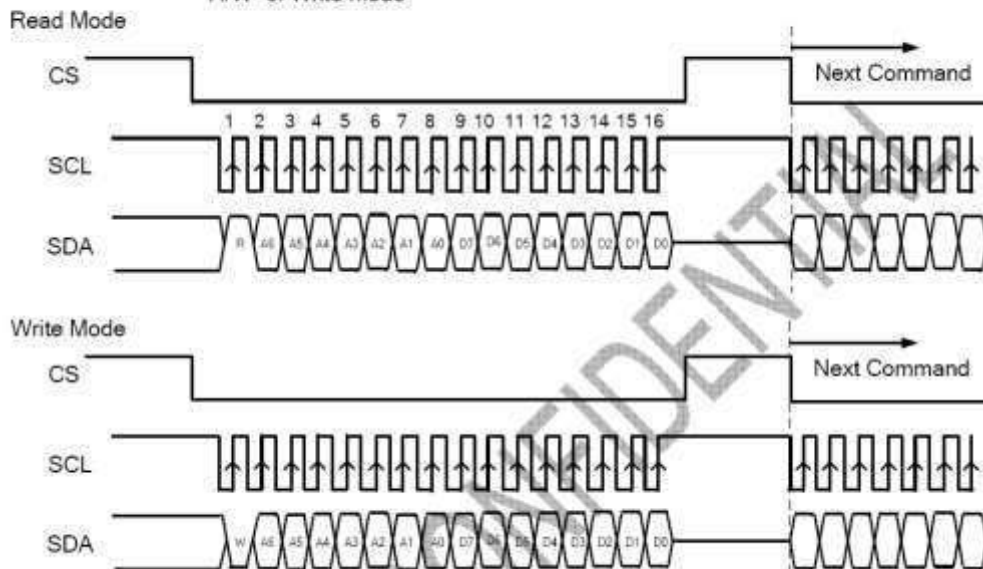

- Each serial command consists of 16 bits of data which is loaded one bit a time at the rising edge of serial clock SCL.
- Command loading operation starts from the falling edge of CS and is completed at the next rising edge of CS.
- The serial control block is operational after power on reset, but commands are established by the VSYNC signal. If command is transferred multiple times for the same register, the last command before the VSYNC signal is valid.
- If less than 16 bits of SCL are input while CS is low, the transferred data is ignored.
- If 16 bits or more of SCL are input while CS is low, the previous 16 bits of transferred data before then rising edge of CS pulse are valid data.
- Serial block operates with the SCL clock.
- Serial data can be accepted in the power save mode.
- After power on reset or GRB reset, it is required 100ms delay to begin SPI communication.

## 8.2. RGB Interface

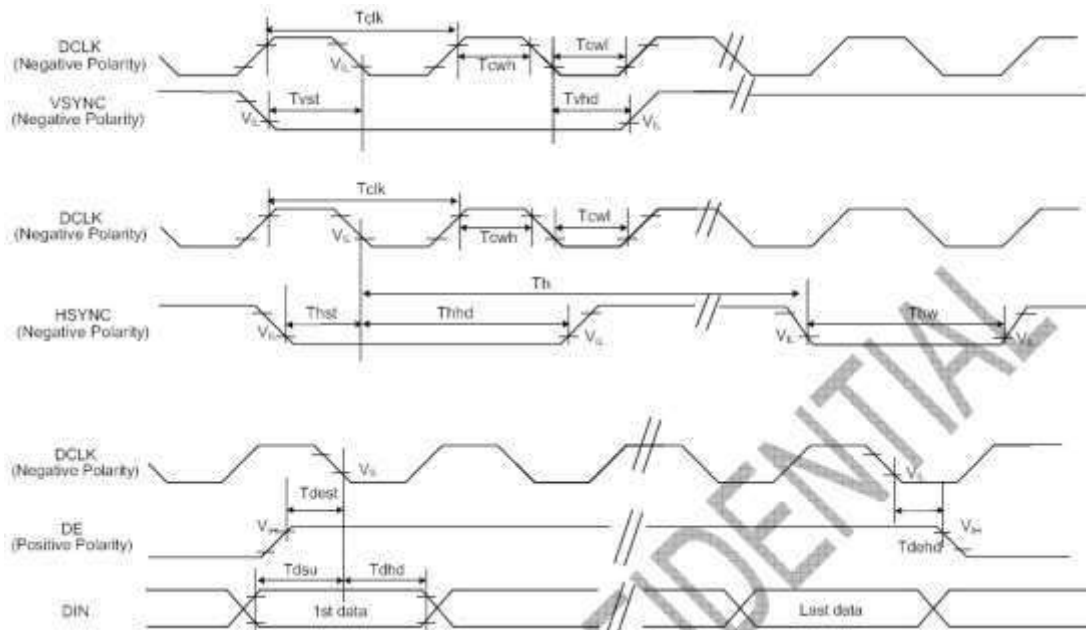

Item	Symbol	Min.	Typ.	Max.	Unit	Conditions
CLK Pulse Duty	$T_{clk}$	40	50	60	%	
HSYNC Width	$T_{hw}$	2	-	-	DCLK	
HSYNC Period	$T_h$	55	60	65	us	
VSYNC Setup Time	$T_{vst}$	12	-	-	ns	
VSYNC Hold Time	$T_{vhd}$	12	-	-	ns	
HSYNC Setup Time	$T_{hst}$	12	-	-	ns	
HSYNC Hold Time	$T_{hhd}$	12	-	-	ns	
Data Setup Time	$T_{dsu}$	12	-	-	ns	
Data Hold Time	$T_{dhhd}$	12	-	-	ns	
DE Setup Time	$T_{dst}$	12	-	-	ns	
DE Hold Time	$T_{dehd}$	12	-	-	ns	

Parallel 24-bit RGB Input Timing (PVDD=VDD=VDDI= 3.3V, AGND= 0V, TA=25°C)

Parallel 24-bit RGB Input Timing Table							
Item	Symbol	Min.	Typ.	Max.	Unit	Note	
DCLK Frequency	$F_{clk}$	5	6	8	MHz		
DCLK Period	$T_{clk}$	125	167	200	ns		
HSYNC	Period Time	$T_h$	325	371	438	DCLK	
	Display Period	$T_{hdisp}$		320		DCLK	
	Back Porch	$T_{hbp}$	3	43	43	DCLK	SYNC mode back porch control by H_BLANKING[7:0] setting $T_{hbp} = H\_BLANKING[7:0]$
	Front Porch	$T_{hfp}$	2	8	75	DCLK	
	Pulse Width	$T_{hw}$	2	4	43	DCLK	
VSYNC	Period Time	$T_v$	244	260	289	HSYNC	
	Display Period	$T_{vdisp}$		240		HSYNC	
	Back Porch	$T_{vbp}$	2	12	12	HSYNC	SYNC mode back porch control by V_BLANKING[7:0] setting $T_{vbp} = V\_BLANKING[7:0]$
	Front Porch	$T_{vfp}$	2	8	37	HSYNC	
	Pulse Width	$T_{vw}$	2	4	12	HSYNC	

Note: It is necessary to keep  $T_{vbp} = 12$  and  $T_{hbp} = 43$  in sync mode. DE mode is unnecessary to keep it.

## 8.2.1. SYNC Mode

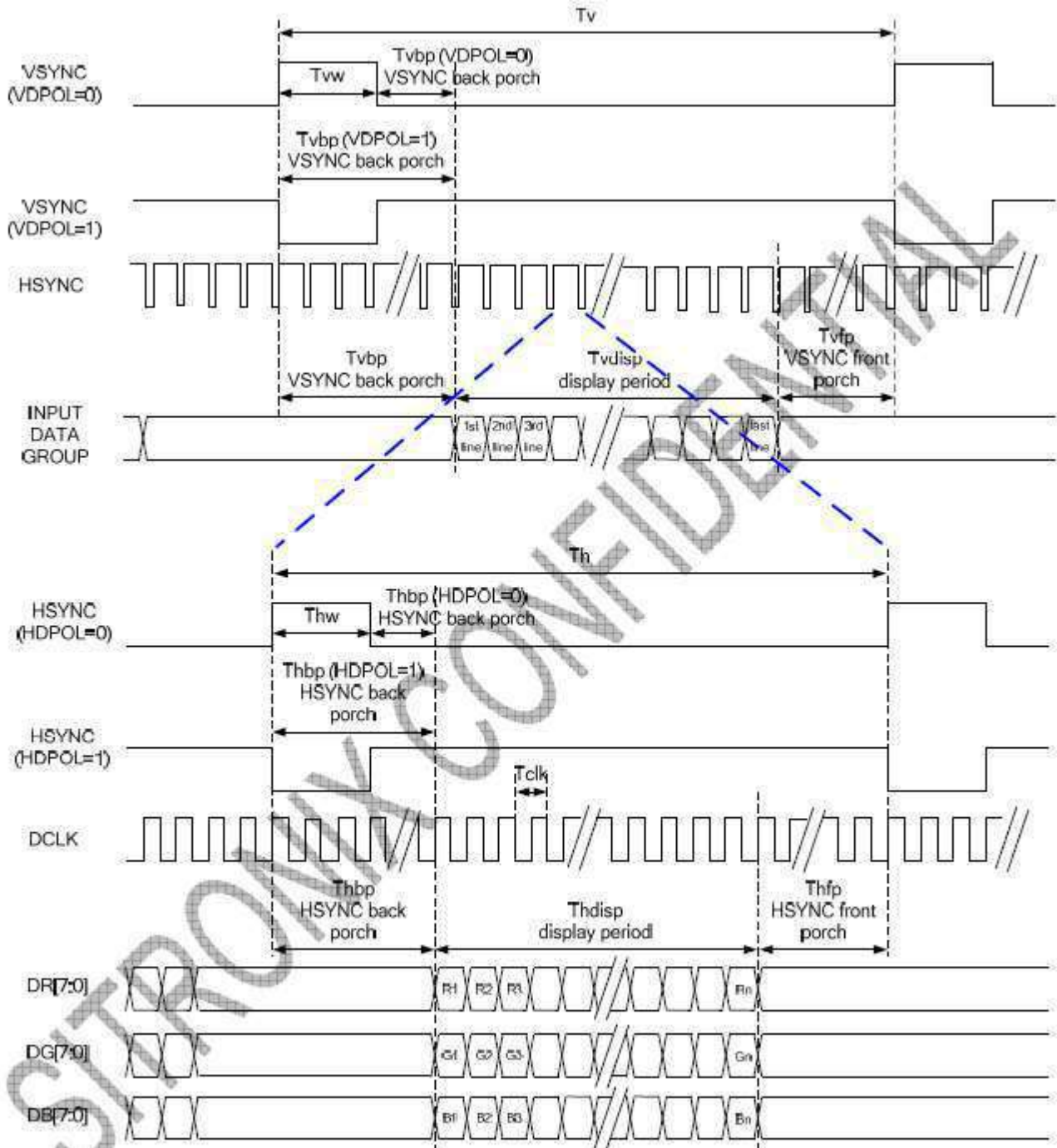

## 8.2.2. SYNC-DE Mode

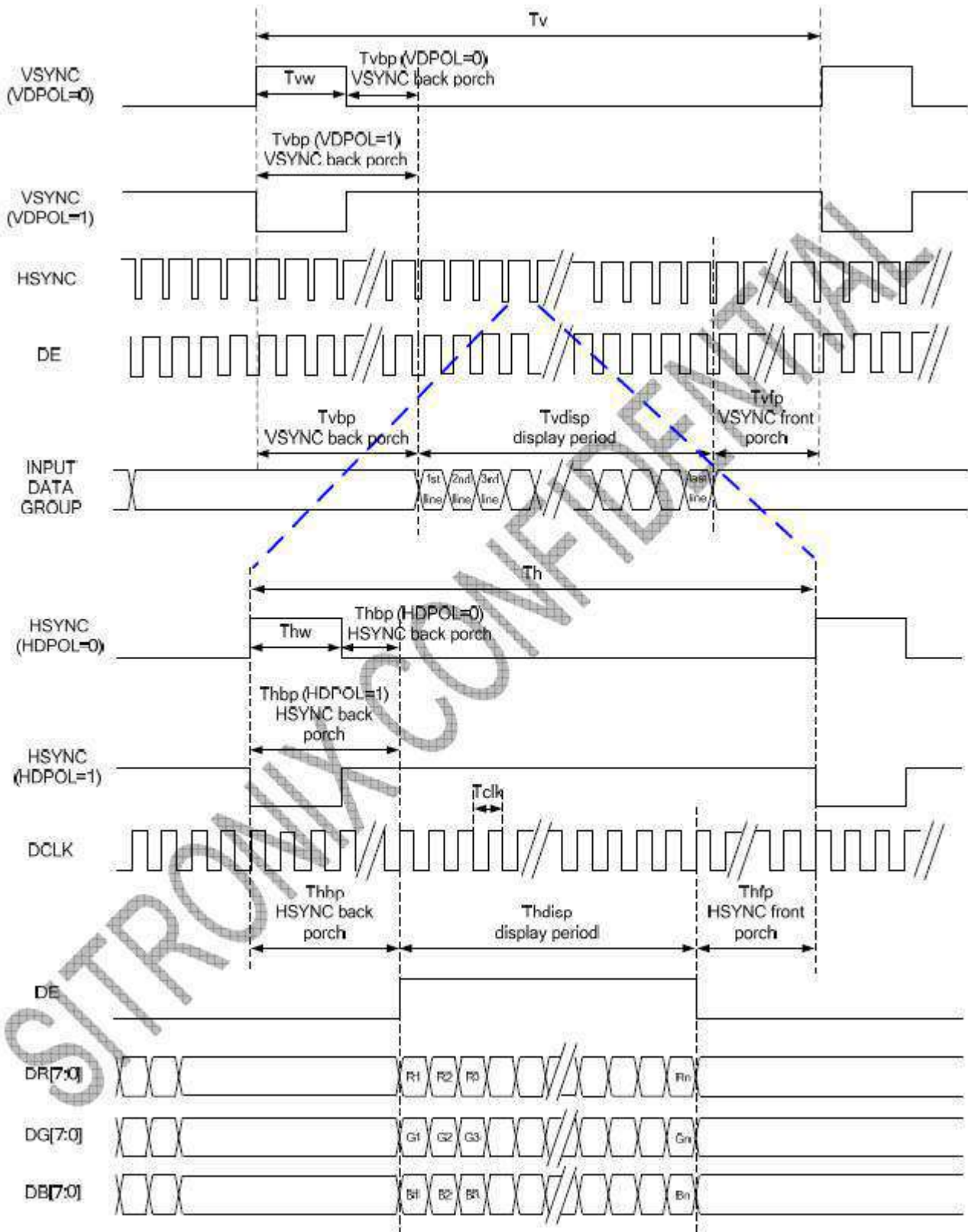

### 8.2.3. DE Mode

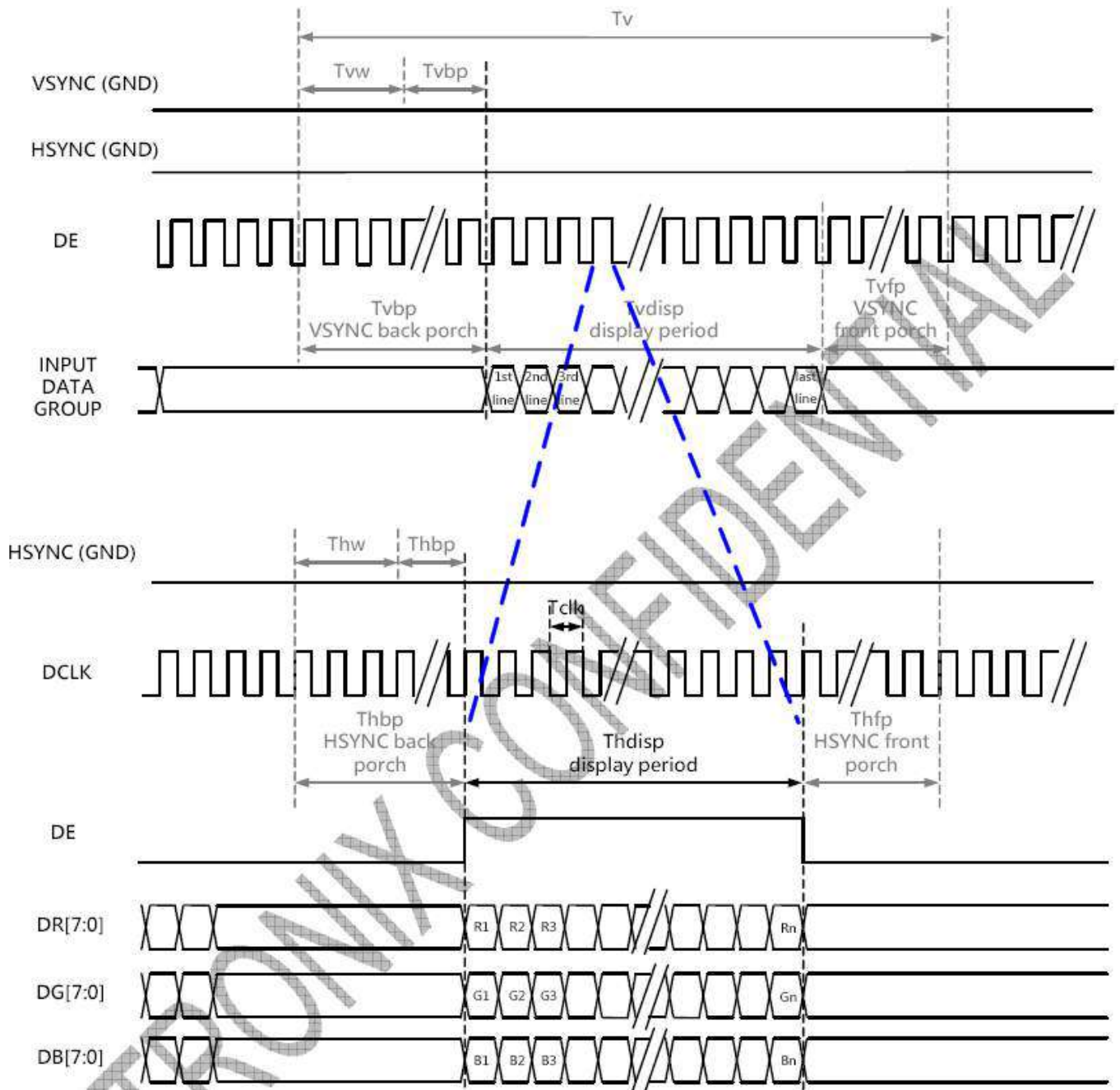

## 9. POWER SEQUENCE

### Power On Sequence

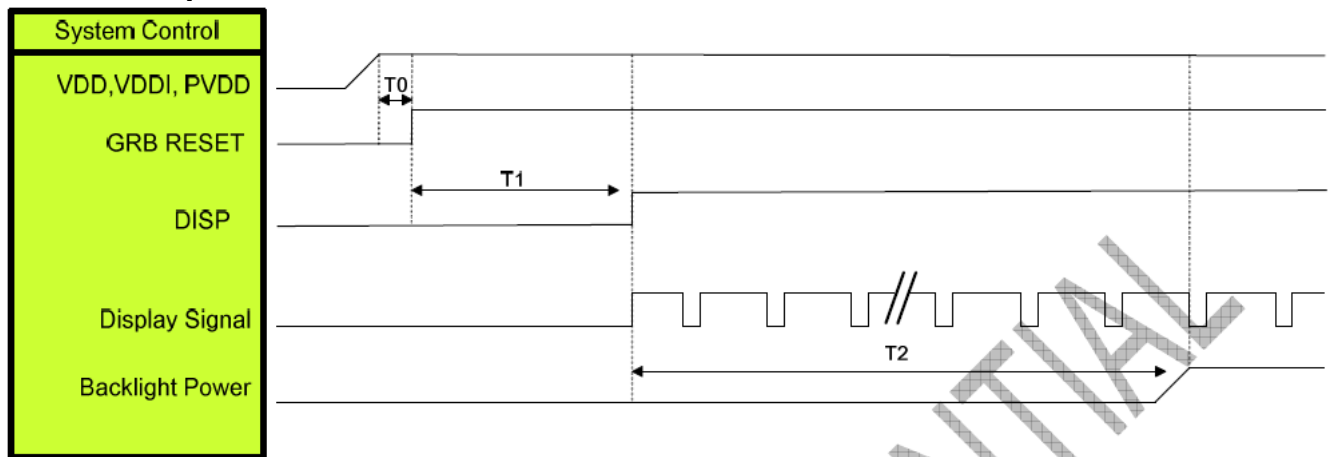

Symbol	Description	Min. Time	Unit
T0	System power stability to GRB RESET signal	0	ms
T1	GRB RESET= "High" to DISP="High"	10	ms
T2	Display Signal output to Backlight Power on	250	ms

Note: Display signal: DCLK; VSYNC; HSYNC; DE; DR[7:0]; DG[7:0]; DB[7:0]

### Power Off Sequence

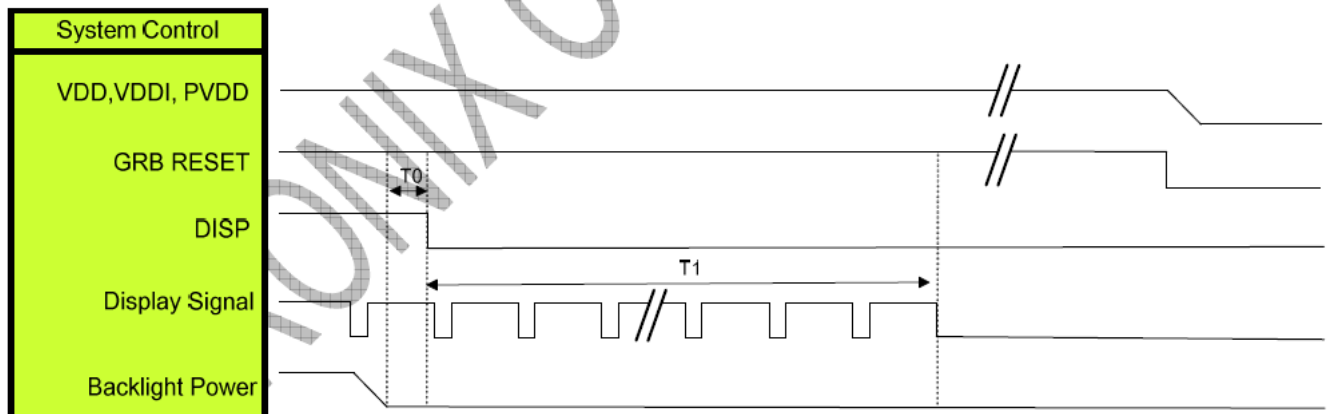

Symbol	Description	Min. Time	Unit
T0	Backlight Power off to DISP="Low"	5	ms
T1	DISP="Low" to IC internal voltage discharge complete	80	ms

Note: Display signal: DCLK; VSYNC; HSYNC; DE; DR[7:0]; DG[7:0]; DB[7:0]

## 10. RELIABILITY TEST CONDITIONS

No.	Test item	Test condition	Inspection after test	
10.1	High temperature storage test	+80C/240 hours	Inspection after 2~4hours storage at room temperature, the sample shall be free from defects : 1.Current changing value before test and after test is 50% larger; 2. Function defect : Non-display,abnormal-d isplay,missing lines, Short lines,I/O corrosion; 3.Visual defect : Air bubble in the LCD,Seal leak,Glass crack.	
10.2	Low temperature storage test	-30°C/240 hours		
10.3	High temperature operating test	+70°C/120 hours		
10.4	Low temperature operating test	-20°C/120 hours		
10.5	Temperature cycle storage test	-30°C ~ 25°C ~ +80°C/10cycles (30min.) (10min.) (30min.)		
10.6	High temperature high humidity test	+50°C*90% RH/120 hours		
10.7	Vibration test	Frequency : 250 r/min Amplitude : 1 inch Time: 45min		
10.8	Drop test	Drop direction: 1 corner/3 edges/6 sides 10 time		
		Packing weight(kg)		Drop height(cm)
		<11		80±1.6
		11≤G<21	60±1.2	
		21≤G<31	50±1.0	
		31≤G<40	40±0.8	
10.9	ESD test	Air discharge: ±8KV, 10time Contact discharge: ±4KV, 10time		
Remark : 1.The test samples should be applied to only one test item. 2.Sample size for each test item is 3~5pcs. 3.For High temperature high humidity test, Pure water(Resistance>10MΩ) should be used. 4.In case of malfunction defect caused by ESD damage, if it would be recovered to normal state after resetting, it would be judged as a good part. 5.B/L evaluation should be excepted from reliability test with humidity and temperature: Some defects such as black spot/blemish can happen by natural chemical reaction with humidity and Fluorescence B/L has. 6.Failure judgment criterion: Basic specification, Electrical characteristic, Mechanical characteristic, Optical characteristic.				



# 11. INSPECTION CRITERION

## 11.1 Objective

The TFT test criterion are set to formalize TFT quality standards for ODNA with reference to those of the customer for inspection, release and acceptance of finished TFT products in order to guarantee the quality of TFT products required by the customer.

## 11.2. Scope

The criterion is applicable to all the TFT products manufactured by ODNA.

## 11.3. Equipment for Inspection

Electrical tester, electrical testing machines, vernier calipers, microscopes, magnifiers, anti-static wrist straps, finger cots, labels, tri-phase cold and hot shock machine, constant temperature and humidity chamber, backlight table, ovens for high-low temperature experiments, refrigerators, constant voltage power supply (DC), desk Lamps, etc.

## 11.4. Sampling Plan and Reference Standards

11.4.1 Sampling plan :

Refer to National Standard GB/T 2828.1---2012/ISO2859-1:1999, level II of normal levels :

**Major defect: AQL 0.4**

**Minor defect: AQL 1.0**

11.4.2 GB/T 2828.1---2012/ISO2859-1:1999 Sampling check procedure in count

11.4.3 GB/T 18910. Standard for LCM parts

11.4.4 GB/T24213-2008 Basic Environmental Test Procedures for Electrical and Electronic Products

11.4.5 IPC-A-610E Acceptability of Electronic Assemblies

## 11.5. Inspection Conditions and Inspection Reference

11.5.1 Cosmetic inspection: shall be done normally at  $23\pm 5^{\circ}\text{C}$  of the ambient temperature and 45~75%RH of relative humidity, under the ambient luminance between 500lux~1000lux and at the distance of 30cm apart between the inspector's eyes and the LCD panel and normally in reflected light. For backlight LCM, cosmetic inspection shall be done under the ambient luminance less than 100lux with the backlight on.

11.5.2 The TFT shall be tested at the angle of  $45^{\circ}$  left and right and  $0-45^{\circ}$  top and bottom as the following picture showing:

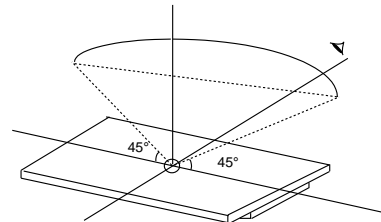
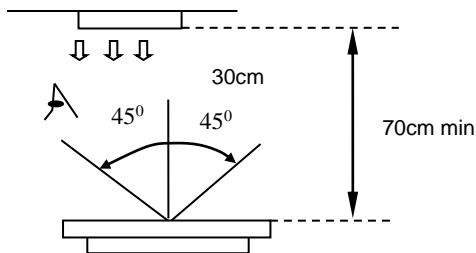

### 11.5.3 Definition of viewing area(VA)

A area : Active area(AA area)

B area : Viewing area(VA area)

C area : Non-viewing area(not viewing after customer assembly)

If there is any appearance viewing defect which do not affect product quality and customer assembly in C area, it's accepted in generally.

The criteria apply to A and B area except chipping and crack.

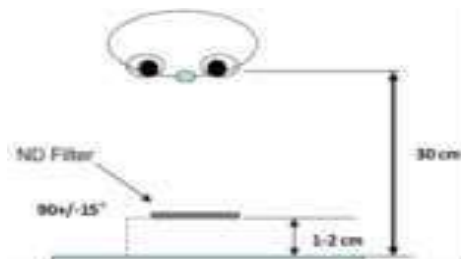
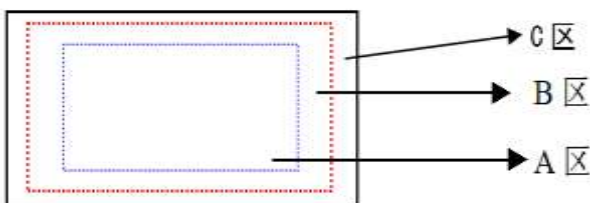

11.5.4 Inspection with naked eyes(exclusive of the inspection of the physical dimensions of defects carried out with magnifiers)

11.5.5 ND card use method(refer to right conner image) and scope: Multi-bright dot; Mura(Black/Gray pattern uneven); dark line and so on.

11.5.6 Undefined items or other special items, refer to mutual agreement and limited sample.If criterion does not match product specifications/ technical requirement, both should be subject to special inspection criterion agreed by customer.







### 11.6. Defects and Acceptance Standards

#### 11.6.1 Electrical properties test

11.6.1.1 Test voltage(V) : Refer to the instruction of testers and the product specification or drawing and the display content and parameters and display effects shall conform to the product specification and drawing.

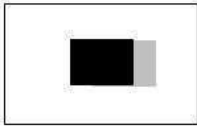
11.6.1.2 Current Consumption(I) : Refer to approved product specifications or drawings.

11.6.1.3 Function items(Defect category : MA.)

No.	Defects	Descriptions	Pictures	Inspection method/tools	Defect category
11.6.1.3.1	No display /reaction	shows no picture/display in normal connected situation.		Naked eyes/ testers	MA.
11.6.1.3.2	Missing segment	Shows missing lines in normal display		Naked eyes/ testers	MA.
11.6.1.3.3	Dark line	Only visible on gray pattern, 1 or more vertical/horizontal lines:5%ND,not visible,OK	/	Naked eyes/ testers	MA.
11.6.1.3.4	POL angle defect	Not accepted		Naked eyes/ testers	MA.
11.6.1.3.5	Image retention (sticking)	Chess pattern stays for 30mins and change to 50% gray pattern,disappear time <10s, OK; if time>10s, NG		Naked eyes/ testers	MA.
11.6.1.3.6	Flicker	Refer to limit sample if essential or flicker value<-30dB(measured by CA310A); OK		Naked eyes/ CA310A	MA.
11.6.1.3.7	Display abnormal	Not accepted		Naked eyes/ testers	MA.
11.6.1.3.8	Cross-talk	Refer to limited sample		Naked eyes/ limited sample	MA.
11.6.1.3.9	Display dim/bright	Refer to limited sample	/	Naked eyes/ limited sample	MA.
11.6.1.3.10	Contrast	Refer to limited sample	/	Naked eyes/ limited sample	MA.
11.6.1.3.11	Huge current	Out of spec, not accepted	/	Ammeter	MA.
11.6.1.3.12	TP	Not accepted	/	Naked eyes/ testers	MA.

	function defect			Touch/ test program	
--	-----------------	--	--	------------------------	--

### 11.6.2 LCD dot/line defect



#### 11.6.2.1 LCD pixel dot defect(defect category : MI.)

Item	Inspection criterion		
	Size	S<5"	5"≤S<10"
Color pixel dot defect(RGB dot)	1	2	2
2 connected bright dot	0	1	1
3 connected bright dot or more	0	0	1
Bright dot quantity	1	2	3
Random dark dot quantity	2	3	4
2 connected dark dot	1	1	2
3 connected dark dot or more	0	0	0
Dark dot quantity	3	4	5
Multi-bright dot	ND 3%hidden, OK		

Remark: 2 bright dots distance DS≥15mm 2 dark dots distance DS≥5mm

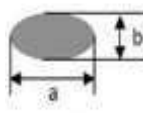

- Bright dot: Power on TFT and RGB dot in black display
- Dark dot: Power on TFT and gray or black dot in RGB display
- Multi-bright dot: Power on TFT and fluorescent tiny dot in black display(only visible in black display)

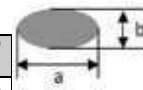
#### 11.6.2.2 LCD appearance dot defect (defect category : MI.)

No.	Item	Inspection criterion				Picture	Inspection method/tools	
		Size	S<5"	5"≤S<10"	10"≤S<15"			
11.6.2.2.1	Dot defect (black dot, white dot)	D≤0.15	Not count	Not count	D≤0.2mm	 D=(a+b)/2	Naked eyes /film card /magnifier	
		0.15<D≤0.25	3	3	Not count			
		0.25<D≤0.30	1	2	0.2~0.35mm			
		0.30<D≤0.35	0	1	Q'ty ≤ 4			
		0.35<D≤0.50	0	0	1			
		D>0.5	0	0	0			
Remark : D≤0.15mm, not count.Multi-dot as bulk is not accepted. Count dot quantity≤ 5 2 round dots or linear dots in 1 cm is judged as multi-dot.								
11.6.2.2.2	Line defect (visible when power on)	Length (mm)	Width (mm)	S<5"	5"≤S<10"	10"≤S<15"		Naked eyes /film card /magnifier
		Not count	W≤0.03	Accepted	Accepted	Accepted		
		L≤5	0.03≤W<0.05	3	3	Not count		
		L≤5	0.05≤W<0.08	0	1	3		
		L≤8	0.05≤W<0.08	0	0	1		
		L>8	W>0.08	0				
Remark : Invisible when power on,only visible in special angle against light, show as watermark/folding/scratch but can not be touched, no control or refer to keeping sample.								
11.6.2.2.3	Polarizer convex-	Size(mm)	S<5"	5"≤S<10"	10"≤S<15"		Naked eyes /film card	
		D≤0.20	Not count	Not count	Not count			

concave dot defect, polarizer bubble defect	0.20<D≤0.5	2	2	3	/magnifier
	0.50<D≤0.8	0	1		
	0.8<D≤1.5	0	0	1	
	D>1.5mm	0	0	0	

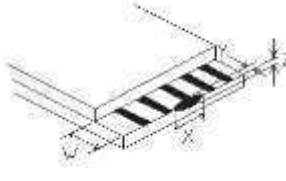
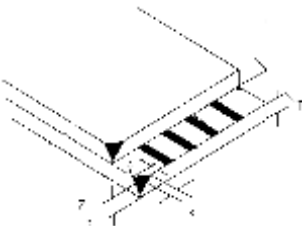
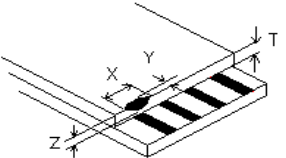
### 11.6.3 Chipping defect

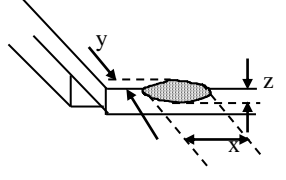
No.	Item	Accepted criterion(mm)				MA.	MI.
11.6.3.1	ITO conductive side 	X	/	≤1/8L	/		√
		Y	Y≤1/6W	1/6W <Y≤1/4W	1/4W <Y		
		Accept	2	2	0		
11.6.3.2	Corner chipping (ITO pins position) 	X	/	≤1/6L	/		√
		Y	Y≤1/2W	1/2W <Y≤W	W <Y		
		Accept	2	1	0		
		Corner chipping occurred in sealed edge position as per 6.3.3; at the same time it should not enter into black border of the frame and the corner chipping effect the electric connection position perform as per 6.3.1.					
11.6.3.3	Chipping in sealed area (outside chipping)   Chipping in sealed area (inside chipping) 	X	/	≤1/8L	/		√
		Y(outside chipping)	Not enter into sealant	Enter Y≤H	H<Y		
		Y(inside chipping)		Enter Y≤1/2H	1/2H<Y		
		Z	≤T	≤1/2T	/		
		Accept	2	1	0		
		The standards of inner and outer chipping on edge sealing area are same. When the chipping occurred in the opposite of stage, Y as per the chipping on the non-conduction side standard in 6.3.1					
11.6.3.4	Conductive side (back side chipping) 	X	/	≤1/6L	/		√
		Y	Y≤1/3W	1/3W <Y≤2/3W	2/3W <Y		
		Accept	2	2	0		
		Chipping into ITO side, refer to 6.3.1					
11.6.3.5	Protruding LCD poor cutting and LCD burrs	X	/	≤1/8L	/		√
		Y	≤1/6W	1/6W <Y≤1/5W	1/5W <Y		

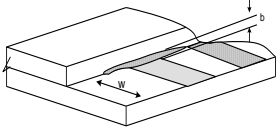
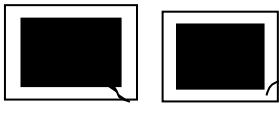
		Z	/	/	/		
		Accept	1	1	1		
		The outside protruding control as per the tolerance of drawing.					
11.6.3.6	<p>Crack</p> 	Not allow to occur cracks without direction; the crack expand to inside is NG, but to outside is OK (confirmed as per the damaged standard)					√
<p>Remark :</p> <p>X means the length of chipping;</p> <p>Y means the width;</p> <p>Z means the thickness;</p> <p>W means the step width of the two glasses;</p> <p>H means the distance from the glass edge to the sealant inner edge;</p> <p>T means glass thickness.</p>							

#### 11.6.4 Backlight components

No.	Item	Description	Accepted criterion	MA.	MI.
11.6.4.1	No backlight wrong Color	/	Rejected	√	
11.6.4.2	Color deviation	When powered on, the LCD color differs from its sample and found that the color not conforming to the drawing after testing.	Refer to sample and drawing		√
11.6.4.3	Brightness deviation	When powered on, the LCD brightness differs from its sample and is found after testing not conforming to the drawing; or if it conforms to the drawing but the brightness over $\pm 40\%$ than its typical value.	Refer to sample and drawing		√
11.6.4.4	Uneven brightness	Uneven on the same LCD and out of the specification of the drawing. The no specification evenness= (the max value-the min value)/ mean value $< 70\%$ .	Refer to sample and drawing		√
11.6.4.5	Spot/line/scratch	When power on, it has dirty spot, scratches and so on spot and line defects.	Refer to 6.2.2		√

#### 11.6.5 Metal frame (Metal Bezel)

No.	Item	Description	Accepted criterion	MA.	MI.
11.6.5.1	Material & surface treatment	Metal frame/surface treatment do not conform to the specifications.	Rejected	√	
11.6.5.2	Tab twist Unconformity /Tab not twisted	Wrong twist method or direction and twist tabs are not twisted as required.	Rejected	√	
11.6.5.3	Bezel paint loss	1.Front surface : Paint peel off and scratch to the bottom	Rejected		√
11.6.5.4	Bezel scratch	Dot:D $\leq 0.5$ mm, exceeds 3; Line:L $\leq 3.0$ mm,W $\leq 0.05$ mm exceeds 2;			√

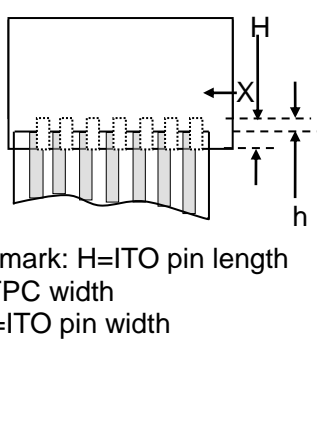

11.6.5.5	Painting peel off, discoloration, dent, and scratch	2.Front dent, air bubble and side with paint peeling off scratch to the bottom Dot: $D \leq 1.0\text{mm}$ , exceeds 3; Line: $L \leq 3.0\text{mm}$ , $W \leq 0.05\text{mm}$ , exceeds 2;			√
11.6.5.6	Burr	Burr(s) on metal bezel is so long as to get into viewing area.	Rejected		√

### 11.6.6 FPC

No.	Item	Description	Accepted criterion	MA.	MI.
11.6.6.1	Model &P/N	Material model & P/N	Keep the same with drawing and technical requirement	√	
11.6.6.2	Dimension/ position	Dimension in drawing spec  Remark: $H = \text{ITO pin length}$ $f = \text{FPC width}$ $W = \text{ITO pin width}$	$f \leq 1/3w$ , $h \leq 1/3H$ , dimension in drawing spec-> OK Conductive material and ITO/PDA connective area must over than 1/2. Entire dimension must be in spec tolerance.		√
11.6.6.3	FPC appearance	Hot pressing material get broken, folding line open; FPC golden finger oxidate, broken ,scratch ,foreign material which cause line short	Broken length < 2mm; FPC line is OK- > Accepted Crack and line broken->Rejected		√
11.6.6.4	FPC burr	Burr near FPC edge area	When cover line and burr length $\leq 1.0\text{mm}$ ->Accepted		√
11.6.6.5	FPC falling off	FPC bonding area falling off ; silica gel breaking	Rejected		√
11.6.6.6	Sealant missing ITO line	Sealant is not covered all ITO line	Rejected	√	
11.6.6.7	Missing sealant	No sealant	Rejected	√	
11.6.6.8	Sealant	Sealant height ->product total height	Rejected	√	

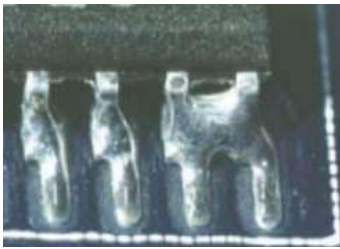

### 11.6.7 SMT

No.	Item	Description	Accepted criterion	MA.	MI.
-----	------	-------------	--------------------	-----	-----

11.6.7.1	Soldering bridge	Solder between adjacent pads and components 	Rejected		√
11.6.7.2	Solder ball/splash	Solder ball/tin dross causing short circuit at the solder point. There are active solder ball and splash.	Rejected		√
11.6.7.3	Soldering excursion	Soldering slant > 1/3 soldering pad 	Rejected		√
11.6.7.4	Component wrong attaching	Component on PCB differs with drawing: wrong one, extra one, lack one, opposite polarity	Rejected	√	
		JUMP short circuit on PCB: extra soldering, lack soldering.	Rejected	√	
11.6.7.5	Component falling off	Soldering but component is missing	Rejected	√	
11.6.7.6	Wrong component	Component model/spec differs from product specification	Rejected	√	

#### 11.6.8 General Appearance

No.	Item	Description	Accepted criterion	MA.	MI.
11.6.8.1	Dimension	According to drawing	Accepted	√	
11.6.8.2	Surface stain	Defect mark or label are not removed residual glue, and finger print, etc;	Rejected		√
11.6.8.3	Assembly foreign material	Dot/linear stain after assembly backlight and diffuse film TP assembly foggy stain	Invisible when power on->OK Refer to 6.2.2 dot/line spec		√
11.6.8.4	Mixture	Different model product in the same shipment	Rejected	√	
11.6.8.5	Product mark	Missing, unclear, incorrect, or misplaced part	Rejected		√
11.6.8.6	Component mark	Silk screen mark clear, resistance measured value in spec	Accepted (Refer to customer special requirement)		√
11.6.8.7	Newton's rings	Area < 1/6 screen area quantity ≤ 1	Accepted		√
11.6.8.8	Mura	1. In black display ND 3% invisible ->OK; visible->NG 2. Naked eyes inspection RGB display invisible Black display, area < 1/4 screen area	Refer to limited sample 		√

11.6.8.9	Light leak	<p>1.LCD edge(near backlight) shadow by LCD lamps irregular illuminate 2.Judge in black/white/gray display (slight leaky is yellowish,greenish, blueish -&gt;NG);</p> <p>Tape 浮起漏光    Panel 側邊漏光  </p>	Refer to limited sample		√
11.6.8.10	Polarizer	<p>1.Polarizer slant.Cover VA and not over LCD edge 2.No unmovable stain or finger print in polarizer VA 3.Bubble/warped but not enter VA</p>	Accepted		√
11.6.8.11	TP defect	<p>1.TP crack 2.TP stain(fogy&amp; unremovable) 3.TP glue overflow to VA</p>	Rejected		√

Remark :

Anything which is not clearly defined in 6.5~6.8 should refer to IPC-A-610E.Consumer Electronics, Non-consumer Electronics refer to I grade and Industrial,Automobile refer to II grade.

### 11.7 Others

Items not specified in this document or released on compromise should be inspected with reference to mutual agreement and limit samples.



## **12. HANDLING PRECAUTIONS**

### **12.1 Mounting method**

The LCD module consists of two thin glass plates with polarizers which easily be damaged. And since the module is so constructed as to be fixed by utilizing fitting holes in the printed circuit board.

Extreme care should be needed when handling the LCD modules.

### **12.2 Caution of LCD handling and cleaning**

When cleaning the display surface, Use soft cloth with solvent [recommended below] and wipe lightly :

- .Isopropyl alcohol
- .Ethyl alcohol

Do not wipe the display surface with dry or hard materials that will damage the polarizer surface.

Do not use the following solvent :

- .Water
- .Aromatics

Do not wipe ITO pad area with the dry or hard materials that will damage the ITO patterns

Do not use the following solvent on the pad or prevent it from being contaminated :

- .Soldering flux
- .Chlorine (Cl) , Sulfur (S)

If goods were sent without being silicon coated on the pad, ITO patterns could be damaged due to the corrosion as time goes on.

If ITO corrosion happens by miss-handling or using some materials such as Chlorine (Cl), Sulfur (S) from customer, Responsibility is on customer.

### **12.3 Caution against static charge**

The LCD module uses C-MOS LSI drivers, so we recommend that you :

Connect any unused input terminal to V<sub>dd</sub> or V<sub>ss</sub>, do not input any signals before power is turned on, and ground your body, work/assembly areas, assembly equipment to protect against static electricity.

### **12.4 Packing**

Module employs LCD elements and must be treated as such.

- .Avoid intense shock and falls from a height.
- .To prevent modules from degradation, do not operate or store them exposed direct to sunshine or high temperature/humidity.

### **12.5 Caution for operation**

●.It is an indispensable condition to drive LCD's within the specified voltage limit since the higher voltage than the limit causes the shorter LCD life.

●.An electrochemical reaction due to direct current causes LCD's undesirable deterioration, so that the use of direct current drive should be avoided.

●.Response time will be extremely delayed at lower temperature than the operating temperature range and on the other hand at higher temperature LCD's show dark color in them. However those phenomena do not mean malfunction or out of order with LCD's, which will come back in the specified operation temperature.

●.If the display area is pushed hard during operation, some font will be abnormally displayed but it resumes normal condition after turning off once.

●.A slight dew depositing on terminals is a cause for electro-chemical reaction resulting in terminal open circuit.

●.Usage under the maximum operating temperature, 50%Rh or less is required.

●.When fixed patterns are displayed for a long time, remnant image is likely to occur.

### **12.6 Storage**

In the case of storing for a long period of time for instance, for years for the purpose or replacement use, the following ways are recommended.

●.Storing in an ambient temperature 10°C to 30°C, and in a relative humidity of 45% to 75%. Don't expose to sunlight or fluorescent light.

●.Storing in a polyethylene bag with the opening sealed so as not to enter fresh air outside in it . And with no desiccant.

●.Placing in a dark place where neither exposure to direct sunlight nor light's keeping the storage temperature range.

●.Storing with no touch on polarizer surface by anything else.

It is recommended to store them as they have been contained in the inner container at the time of delivery from us.

### **12.7 Safety**

- .It is recommendable to crash damaged or unnecessary LCD's into pieces and wash off liquid crystal by either of solvents such as acetone and ethanol, which should be burned up later.
- .When any liquid leaked out of a damaged glass cell comes in contact with your hands, please wash it off well with soap and water.

### **13. PRECAUTION FOR USE**

**13.1** A limit sample should be provided by the both parties on an occasion when the both parties agreed its necessity. Judgment by a limit sample shall take effect after the limit sample has been established and confirmed by the both parties.

**13.2** On the following occasions, the handing of problem should be decided through discussion and agreement between responsible of the both parties.

- .When a question is arisen in this specification.
- .When a new problem is arisen which is not specified in this specifications.
- .When an inspection specifications change or operating condition change in customer is reported to ODNA, and some problem is arisen in this specification due to the change.
- .When a new problem is arisen at the customer's operating set for sample evaluation in the customer site.

### **14. PACKING SPECIFICATION**

Please consult our technical department for detail information.