



# **ORIENT DISPLAY**

Your Total LCD Solution Provider

## Specification for TFT

### AFY240320A0-2.4INTH-R

Revision O



|        |                                                  |
|--------|--------------------------------------------------|
| A      | Orient Display                                   |
| FY     | TFT Type                                         |
| 240320 | Resolution 240 x 320                             |
| A0     | Serial A0                                        |
| 2.4    | 2.4", Module Dimension 42.72 x 58.50 x 3.30 mm   |
| I      | IPS Display                                      |
| N      | Top: -20~+70°C; Tstr: -30~+80°C                  |
| T      | Transmissive                                     |
| H      | High Brightness, 800 cd/m2                       |
| R      | Resistive Touch Panel                            |
| /      | Controller <a href="#">ST7789V</a> Or Compatible |
| /      | MCU/18bit RGB Interface                          |



## REVISION RECORD

| <b>Rev No.</b> | <b>Rev date</b> | <b>Contents</b> | <b>Remarks</b> |
|----------------|-----------------|-----------------|----------------|
| 0              | 2019-11-28      | First release   | Preliminary    |
|                |                 |                 |                |
|                |                 |                 |                |
|                |                 |                 |                |
|                |                 |                 |                |
|                |                 |                 |                |
|                |                 |                 |                |
|                |                 |                 |                |
|                |                 |                 |                |
|                |                 |                 |                |
|                |                 |                 |                |
|                |                 |                 |                |
|                |                 |                 |                |
|                |                 |                 |                |
|                |                 |                 |                |
|                |                 |                 |                |
|                |                 |                 |                |
|                |                 |                 |                |
|                |                 |                 |                |
|                |                 |                 |                |
|                |                 |                 |                |
|                |                 |                 |                |
|                |                 |                 |                |
|                |                 |                 |                |
|                |                 |                 |                |
|                |                 |                 |                |
|                |                 |                 |                |
|                |                 |                 |                |
|                |                 |                 |                |
|                |                 |                 |                |
|                |                 |                 |                |
|                |                 |                 |                |
|                |                 |                 |                |
|                |                 |                 |                |
|                |                 |                 |                |
|                |                 |                 |                |
|                |                 |                 |                |
|                |                 |                 |                |
|                |                 |                 |                |

# CONTENTS

|                                         |    |
|-----------------------------------------|----|
| 1. GENERAL INFORMATION .....            | 3  |
| 2. ABSOLUTE MAXIMUM RATINGS.....        | 3  |
| 3. ELECTRICAL CHARACTERISTICS.....      | 4  |
| 4. BACKLIGHT CHARACTERISTICS .....      | 4  |
| 5. EXTERNAL DIMENSIONS .....            | 5  |
| 6. ELECTRO-OPTICAL CHARACTERISTICS..... | 6  |
| 7. INTERFACE DESCRIPTION.....           | 8  |
| 8.AC CHARACTERISTICS.....               | 9  |
| 9. POWER SEQUENCE.....                  | 14 |
| 10. RELIABILITY TEST CONDITIONS.....    | 15 |
| 11.INSPECTION CRITERION .....           | 16 |
| 12. HANDLING PRECAUTIONS .....          | 23 |
| 13. PRECAUTION FOR USE.....             | 24 |
| 14. PACKING SPECIFICATION.....          | 24 |
| 15. INITIALIZATION CODE .....           | 24 |
| 16. HSF COMPLIANCE .....                | 26 |

## 1. GENERAL INFORMATION

| No. | Item                           | Contents                               | Unit |
|-----|--------------------------------|----------------------------------------|------|
| 1   | LCD size                       | 2.4 inch (Diagonal)                    | /    |
| 2   | Display mode                   | Normally black/Transmissive/Anti-glare | /    |
| 3   | Viewing direction(eye)         | FREE                                   | /    |
| 4   | Gray scale inversion direction | -                                      | /    |
| 5   | Resolution(H*V)                | 240 *320 Pixels                        | /    |
| 6   | Module size (L*W*H)            | 42.72*58.50*3.30                       | mm   |
| 7   | Active area (L*W)              | 36.72*48.96                            | mm   |
| 8   | Pixel pitch (L*W)              | 0.153*0.153                            | mm   |
| 9   | Interface type                 | RGB interface                          | /    |
| 10  | Color Depth                    | 16.7M                                  | /    |
| 11  | Module power consumption       | TBD                                    | W    |
| 12  | Back light type                | LED                                    | /    |
| 13  | Driver IC                      | ST7789V or compatible                  | /    |
| 14  | Weight                         | TBD                                    | g    |

## 2. ABSOLUTE MAXIMUM RATINGS

| Item                               | Symbol | Min. | Max.          | Unit | Note  |
|------------------------------------|--------|------|---------------|------|-------|
| Power supply input voltage for TFT | VDD    | -0.3 | 4.6           | V    |       |
| Backlight current (normal temp.)   | ILED   | -    | 100           | mA   |       |
| Operation temperature              | Top    | -20  | +70           | °C   | Note1 |
| Storage temperature                | Tst    | -30  | +80           | °C   | Note1 |
| Humidity                           | RH     | -    | 90%(Max60 °C) | RH   | Note1 |

Note1 :

- 1).The relative humidity and temperature range are as below sketch,90%RH Max.
- 2).The maximum wet bulb temperature  $\leq 40^{\circ}\text{C}$  and without dewing.

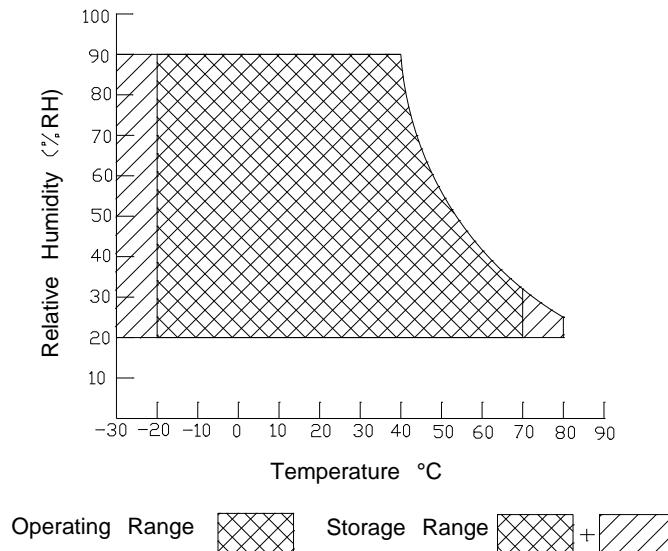

### 3. ELECTRICAL CHARACTERISTICS

#### DC CHARACTERISTICS(at Ta=25°C)

| Item                       | Symbol | Min.     | Typ. | Max.     | Unit | Note |
|----------------------------|--------|----------|------|----------|------|------|
| Power supply input voltage | VCC    | 2.65     | 2.8  | 3.3      | V    |      |
| I/O logic voltage          | VDDIO  | -        | 1.8  | -        | V    | =VCC |
| Input voltage 'H' level    | VIH    | 0.7VDDIO | -    | VDDIO    | V    |      |
| Input voltage 'L' level    | VIL    | VSS      | -    | 0.3VDDIO | V    |      |
| Power supply current       | IVDD   | -        | 9    | -        | mA   |      |

### 4. BACKLIGHT CHARACTERISTICS

#### (at Ta=25°C,RH=60%)

| Item                  | Symbol | Min.          | Typ.  | Max. | Unit | Note      |
|-----------------------|--------|---------------|-------|------|------|-----------|
| LED forward voltage   | VF     |               | 6.0   |      | V    | IF=20*4mA |
| LED forward current   | IF     | -             | 80    | -    | mA   |           |
| LED power consumption | PLED   | -             | 0.256 | -    | W    | Note1     |
| Number of LED         | -      |               | 4     |      | PCS  |           |
| Connection mode       | -      | 4 in parallel |       |      | /    |           |
| LED life-time         | -      | 20000         | -     | -    | Hrs  | Note2     |

Note1 : Calculator value for reference :  $IF \cdot VF = PLED$

Note2 : The LED life-time define as the estimated time to 50% degradation of initial brightness at Ta=25°C and IF =80mA. The LED lifetime could be decreased if operating IF is larger than 80mA.

# 5. EXTERNAL DIMENSIONS

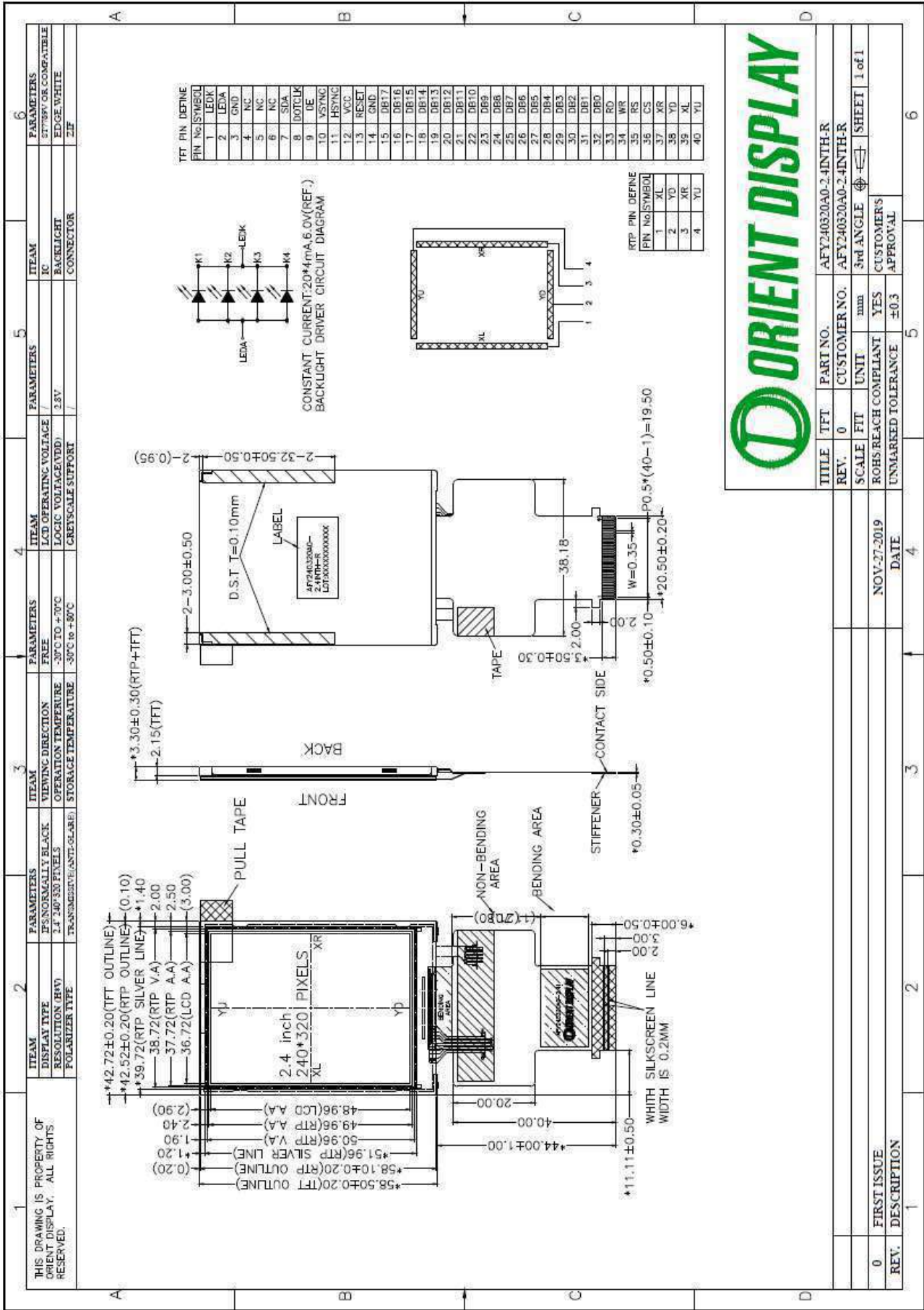

## 6. ELECTRO-OPTICAL CHARACTERISTICS

| Item                   | Symbol   | Condition                                            | Min.         | Typ. | Max.         | Unit              | Remark           | Note   |
|------------------------|----------|------------------------------------------------------|--------------|------|--------------|-------------------|------------------|--------|
| Response time          | Tr+ Tf   | -                                                    | -            | 35   | 45           | ms                | FIG.1            | Note 1 |
| Contrast ratio         | Cr       |                                                      | 500          | 750  | -            | -                 | FIG.2            | Note 2 |
| Surface luminance      | Lv       | $\theta=0^\circ$                                     | 600          | 800  | -            | cd/m <sup>2</sup> | FIG.2            | Note 3 |
| Luminance uniformity   | Yu       | $\theta=0^\circ$                                     | 75           | 80   | -            | %                 | FIG.2            | Note 4 |
| NTSC                   | -        | $\theta=0^\circ$                                     | -            | 50   | -            | %                 | FIG.2            | Note 5 |
| Viewing angle          | $\theta$ | $\varnothing=90^\circ$                               | 70           | 80   | -            | deg               | FIG.3            | Note 6 |
|                        |          | $\varnothing=270^\circ$                              | 70           | 80   | -            | deg               | FIG.3            |        |
|                        |          | $\varnothing=0^\circ$                                | 70           | 80   | -            | deg               | FIG.3            |        |
|                        |          | $\varnothing=180^\circ$                              | 70           | 80   | -            | deg               | FIG.3            |        |
| CIE (x,y) chromaticity | Red x    | $\theta=0^\circ$<br>$\varnothing=0^\circ$<br>Ta=25°C | Typ<br>-0.04 | TBD  | Typ<br>+0.04 | -                 | FIG.2<br>CIE1931 | Note 5 |
|                        | Red y    |                                                      |              | TBD  |              | -                 |                  |        |
|                        | Green x  |                                                      |              | TBD  |              | -                 |                  |        |
|                        | Green y  |                                                      |              | TBD  |              | -                 |                  |        |
|                        | Blue x   |                                                      |              | TBD  |              | -                 |                  |        |
|                        | Blue y   |                                                      |              | TBD  |              | -                 |                  |        |
|                        | White x  |                                                      |              | TBD  |              | -                 |                  |        |
|                        | White y  |                                                      |              | TBD  |              | -                 |                  |        |

### Note1. Definition of response time

The response time is defined as the LCD optical switching time interval between "White" state and "Black" state. Rise time ( $T_{ON}$ ) is the time between photo detector output intensity changed from 90% to 10%. And fall time ( $T_{OFF}$ ) is the time between photo detector output intensity changed from 10% to 90%. For additional information see FIG.1.

### Note2. Definition of contrast ratio

Contrast ratio (Cr) is defined mathematically by the following formula. For more information see FIG.2.

$$\text{Contrast ratio} = \frac{\text{Luminance measured when LCD on the "White" state}}{\text{Luminance measured when LCD on the "Black" state}}$$

Measured at the center area of the LCD

### Note3. Definition of surface luminance

Surface luminance is the luminance with all pixels displaying white. For more information see FIG.2.

$L_v$  = Average Surface Luminance with all white pixels ( $P_1, P_2, P_3, \dots, P_n$ )

### Note4. Definition of luminance uniformity

The luminance uniformity in surface luminance is determined by measuring luminance at each test position 1 through n, and then dividing the maximum luminance of n points luminance by minimum luminance of n points luminance. For more information see FIG.2.

$$Y_u = \frac{\text{Minimum surface luminance with all white pixels (P1,P2,P3,.....,Pn)}}{\text{Maximum surface luminance with all white pixels (P1,P2,P3,.....,Pn)}}$$

### Note5. Definition of color chromaticity (CIE1931)

CIE (x,y) chromaticity, The x,y value is determined by screen active area center position P5. For more information see FIG.2.

### Note6. Definition of viewing angle

Viewing angle is the angle at which the contrast ratio is greater than 10. angles are determined for the horizontal or x axis and the vertical or y axis with respect to the z axis which is normal to the LCD surface. For more information see FIG.3.

For viewing angle and response time testing, the testing data is base on Autronic-Melchers's ConoScope or DMS series Instruments or compatible. For contrast ratio, Surface Luminance, Luminance uniformity and CIE, the testing data is based on TOPCON's BM-5 or BM-7 photo detector or compatible.

**FIG.1. The definition of response Time**

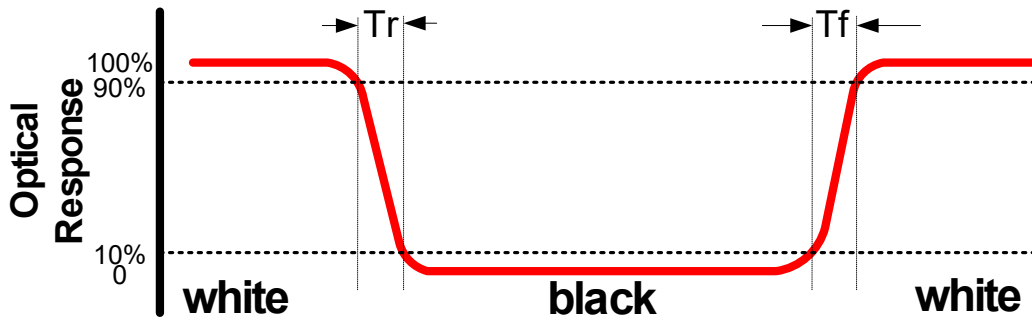

**FIG.2. Measuring method for contrast ratio, surface luminance, luminance uniformity, CIE (x,y) chromaticity**

H,V : Active area

Light spot size  $\varnothing=5\text{mm}$ (BM-5) or  $\varnothing=7.7\text{mm}$  (BM-7)50cm distance or compatible distance from the LCM surface to detector lens.

Test spot position : see Figure a.

measurement instrument : TOPCON's luminance meter BM-5 or BM-7 or compatible ,see Figure b.

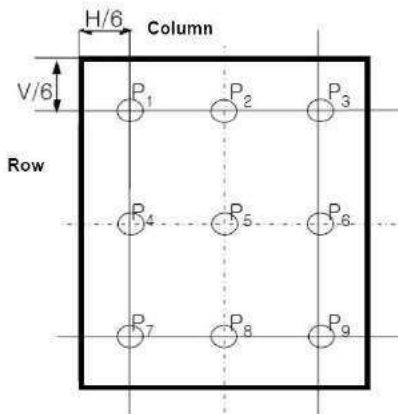

Figure a

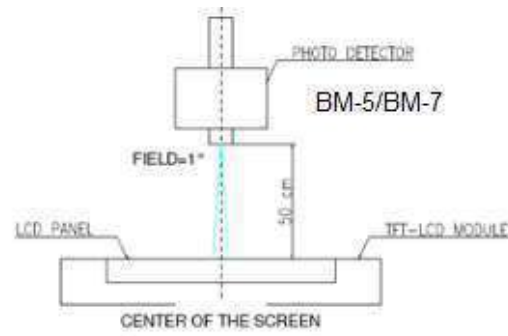
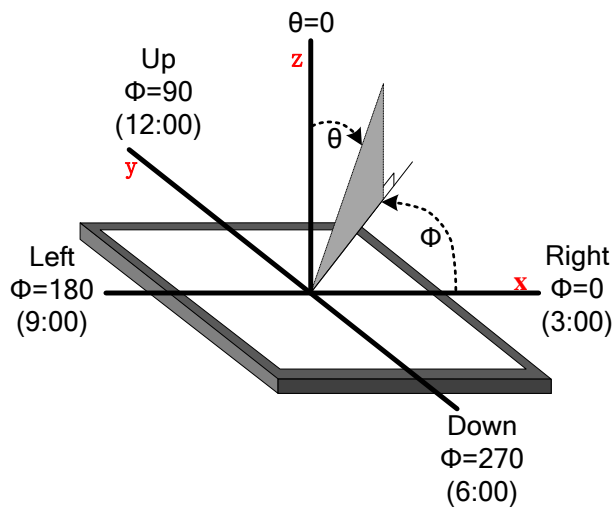

Figure b

**FIG.3. The definition of viewing angle**





## 7. INTERFACE DESCRIPTION

### Module Interface description

| Interface No. | Name             | I/O or connect to | Description                                        |
|---------------|------------------|-------------------|----------------------------------------------------|
| 1             | LEDK             | P                 | Power for LED backlight(Cathode).                  |
| 2             | LEDA             | P                 | Power for LED backlight(Anode).                    |
| 3             | GND              | P                 | Power Ground.                                      |
| 4             | NC               | /                 |                                                    |
| 5             | NC               | /                 |                                                    |
| 6             | NC               | /                 |                                                    |
| 7             | SDA              | I/O               | SPI interface input pin.                           |
| 8             | DOTCLK           | I                 | Dot clock.                                         |
| 9             | DE               | I                 | Data enable.                                       |
| 10            | VSYNC            | I                 | Vertical sync input                                |
| 11            | HSYNC            | I                 | Horizontal sync input                              |
| 12            | VCC              | P                 | Power supply                                       |
| 13            | RESET            | I                 | Reset signal.                                      |
| 14            | GND              | P                 | Power Ground.                                      |
| <b>15-32</b>  | <b>DB17--DB0</b> | <b>I/O</b>        | <b>Data bus (DB17--DB0).</b>                       |
| 33            | RD               | I                 | RGB Interface.please fix this pin at VDDI or DGND. |
| 34            | WR               | I                 | RGB Interface.please fix this pin at VDDI or DGND. |
| 35            | RS(SCL)          | I                 | RGB Interface. serial interface clock.             |
| 36            | CS               | I                 | Chip selection pin. Low enable.                    |
| 37            | XR               | I                 | X-Right                                            |
| 38            | YD               | I                 | Y-Down                                             |
| 39            | XL               | I                 | X-Left                                             |
| 40            | YU               | I                 | Y-Up                                               |

## 8. AC CHARACTERISTICS

### Display Parallel 18/16/9/8-bit Interface Timing Characteristics (8080)

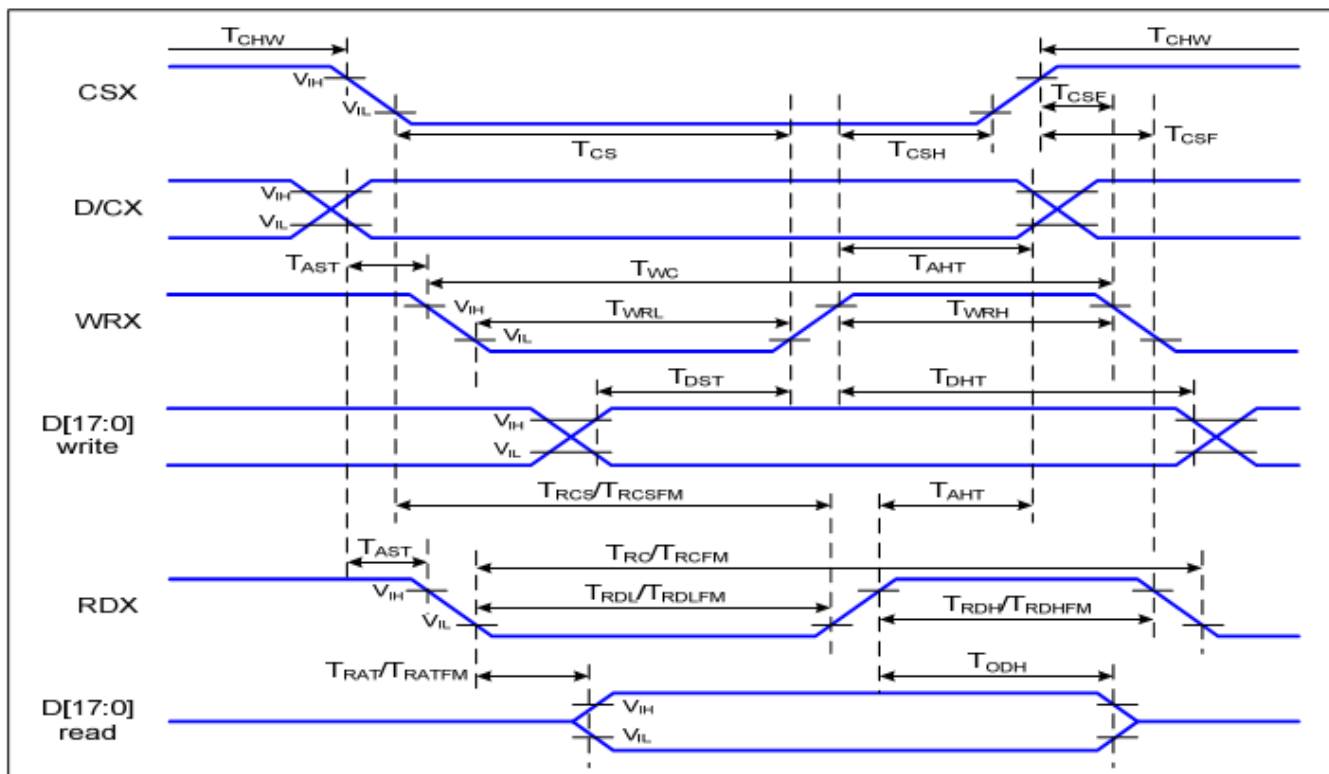

Figure 1 Parallel Interface Timing Characteristics (8080-Series MCU Interface)

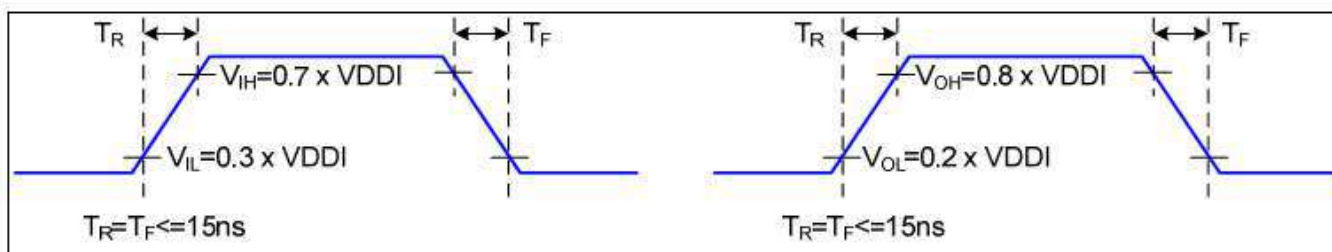

Figure 2 Rising and Falling Timing for I/O Signal

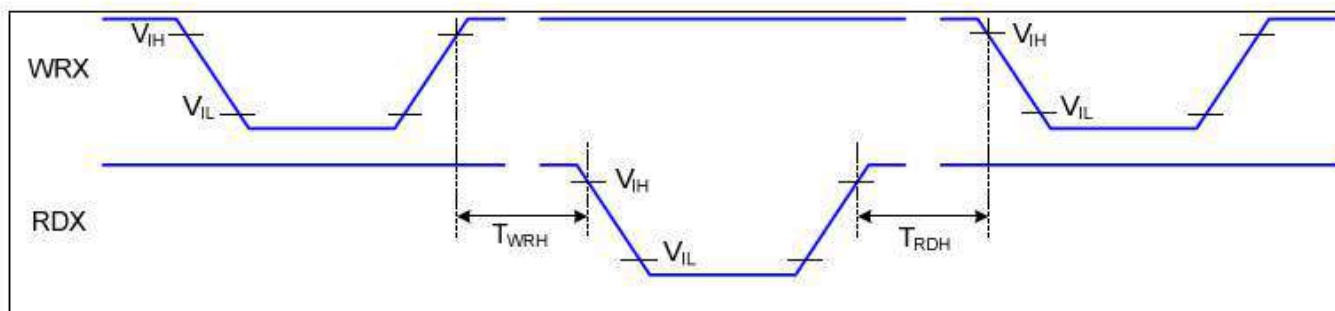
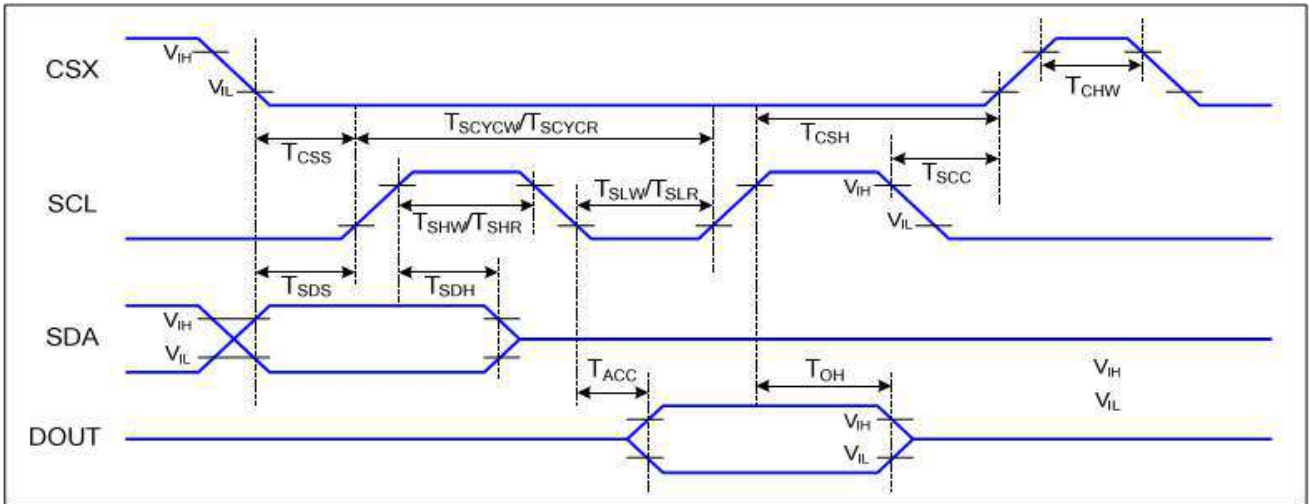

Figure 3 Write-to-Read and Read-to-Write Timing

| Signal   | Symbol             | Parameter                          | Min | Max | Unit | Description                 |
|----------|--------------------|------------------------------------|-----|-----|------|-----------------------------|
| D/CX     | T <sub>AST</sub>   | Address setup time                 | 0   |     | ns   |                             |
|          | T <sub>AHT</sub>   | Address hold time (Write/Read)     | 10  |     | ns   |                             |
| CSX      | T <sub>CHW</sub>   | Chip select "H" pulse width        | 0   |     | ns   |                             |
|          | T <sub>CS</sub>    | Chip select setup time (Write)     | 15  |     | ns   |                             |
|          | T <sub>RCS</sub>   | Chip select setup time (Read ID)   | 45  |     | ns   |                             |
|          | T <sub>RCSFM</sub> | Chip select setup time (Read FM)   | 355 |     | ns   |                             |
|          | T <sub>CSF</sub>   | Chip select wait time (Write/Read) | 10  |     | ns   |                             |
|          | T <sub>CSH</sub>   | Chip select hold time              | 10  |     | ns   |                             |
| WRX      | T <sub>WC</sub>    | Write cycle                        | 66  |     | ns   |                             |
|          | T <sub>WRH</sub>   | Control pulse "H" duration         | 15  |     | ns   |                             |
|          | T <sub>WRL</sub>   | Control pulse "L" duration         | 15  |     | ns   |                             |
| RDX (ID) | T <sub>RC</sub>    | Read cycle (ID)                    | 160 |     | ns   | When read ID data           |
|          | T <sub>RDH</sub>   | Control pulse "H" duration (ID)    | 90  |     | ns   |                             |
|          | T <sub>RDL</sub>   | Control pulse "L" duration (ID)    | 45  |     | ns   |                             |
| RDX (FM) | T <sub>RCFM</sub>  | Read cycle (FM)                    | 450 |     | ns   | When read from frame memory |
|          | T <sub>RDHFM</sub> | Control pulse "H" duration (FM)    | 90  |     | ns   |                             |
|          | T <sub>RDLFM</sub> | Control pulse "L" duration (FM)    | 355 |     | ns   |                             |
| D[17:0]  | T <sub>DST</sub>   | Data setup time                    | 10  |     | ns   | For CL=30pF                 |
|          | T <sub>DHT</sub>   | Data hold time                     | 10  |     | ns   |                             |
|          | T <sub>RAT</sub>   | Read access time (ID)              |     | 40  | ns   |                             |
|          | T <sub>RATFM</sub> | Read access time (FM)              |     | 340 | ns   |                             |
|          | T <sub>ODH</sub>   | Output disable time                | 20  | 80  | ns   |                             |

## Display Serial Interface Timing Characteristics (3-line SPI system)



**Figure 4 3-line serial Interface Timing Characteristics**

VDDI=1.65 to 3.3V, VDD=2.4 to 3.3V, AGND=DGND=0V, T<sub>a</sub>=-30 to 70 °C

| Signal       | Symbol             | Parameter                      | Min | Max | Unit | Description         |
|--------------|--------------------|--------------------------------|-----|-----|------|---------------------|
| CSX          | T <sub>CSS</sub>   | Chip select setup time (write) | 15  |     | ns   |                     |
|              | T <sub>CSH</sub>   | Chip select hold time (write)  | 15  |     | ns   |                     |
|              | T <sub>CSS</sub>   | Chip select setup time (read)  | 60  |     | ns   |                     |
|              | T <sub>SCC</sub>   | Chip select hold time (read)   | 65  |     | ns   |                     |
|              | T <sub>CHW</sub>   | Chip select "H" pulse width    | 40  |     | ns   |                     |
| SCL          | T <sub>SCYCW</sub> | Serial clock cycle (Write)     | 66  |     | ns   |                     |
|              | T <sub>SHW</sub>   | SCL "H" pulse width (Write)    | 15  |     | ns   |                     |
|              | T <sub>SLW</sub>   | SCL "L" pulse width (Write)    | 15  |     | ns   |                     |
|              | T <sub>SCYCR</sub> | Serial clock cycle (Read)      | 150 |     | ns   |                     |
|              | T <sub>SHR</sub>   | SCL "H" pulse width (Read)     | 60  |     | ns   |                     |
|              | T <sub>SLR</sub>   | SCL "L" pulse width (Read)     | 60  |     | ns   |                     |
| SDA<br>(DIN) | T <sub>SDS</sub>   | Data setup time                | 10  |     | ns   |                     |
|              | T <sub>SDH</sub>   | Data hold time                 | 10  |     | ns   |                     |
| DOUT         | T <sub>ACC</sub>   | Access time                    | 10  | 50  | ns   | For maximum CL=30pF |
|              | T <sub>OH</sub>    | Output disable time            | 15  | 50  | ns   | For minimum CL=8pF  |

**Table 5 3-line serial Interface Characteristics**

## Display Serial Interface Timing Characteristics (4-line SPI system)

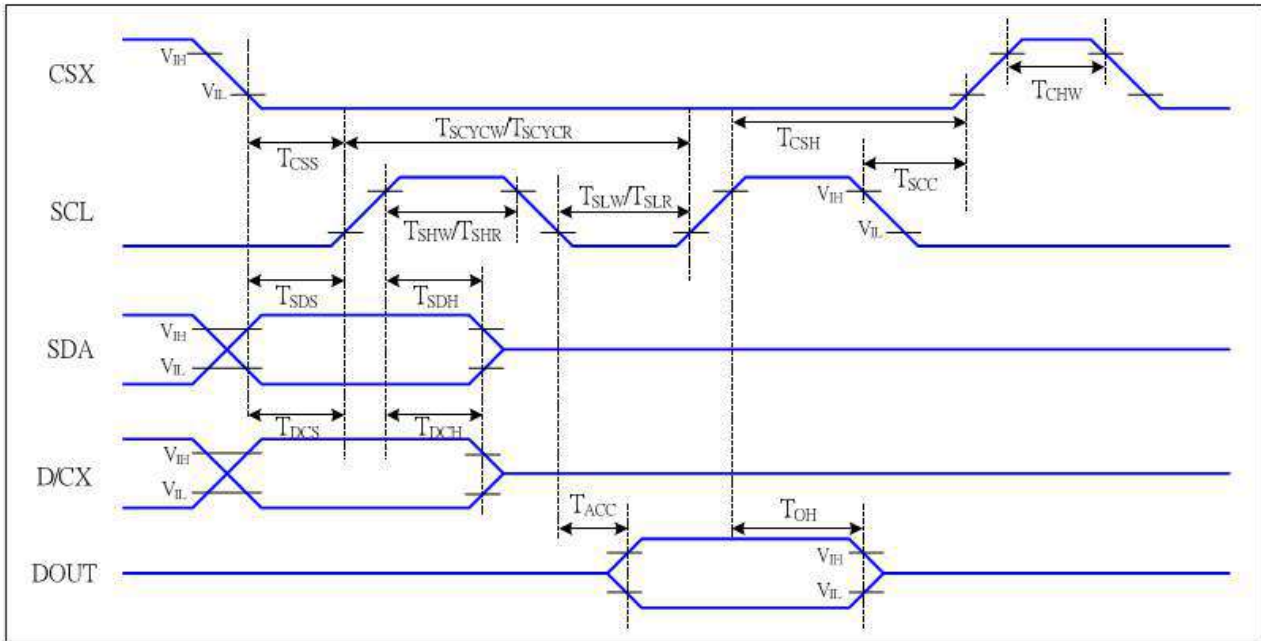

Figure 5 4-line serial Interface Timing Characteristics

VDDI=1.65 to 3.3V, VDD=2.4 to 3.3V, AGND=DGND=0V, Ta=-30 to 70 °C

| Signal    | Symbol             | Parameter                      | MIN | MAX | Unit | Description               |
|-----------|--------------------|--------------------------------|-----|-----|------|---------------------------|
| CSX       | T <sub>CSS</sub>   | Chip select setup time (write) | 15  |     | ns   |                           |
|           | T <sub>CSH</sub>   | Chip select hold time (write)  | 15  |     | ns   |                           |
|           | T <sub>CSS</sub>   | Chip select setup time (read)  | 60  |     | ns   |                           |
|           | T <sub>SCC</sub>   | Chip select hold time (read)   | 65  |     | ns   |                           |
|           | T <sub>CHW</sub>   | Chip select "H" pulse width    | 40  |     | ns   |                           |
| SCL       | T <sub>SCYCW</sub> | Serial clock cycle (Write)     | 66  |     | ns   | -write command & data ram |
|           | T <sub>SHW</sub>   | SCL "H" pulse width (Write)    | 15  |     | ns   |                           |
|           | T <sub>SLW</sub>   | SCL "L" pulse width (Write)    | 15  |     | ns   |                           |
|           | T <sub>SCYCR</sub> | Serial clock cycle (Read)      | 150 |     | ns   | -read command & data ram  |
|           | T <sub>SHR</sub>   | SCL "H" pulse width (Read)     | 60  |     | ns   |                           |
|           | T <sub>SLR</sub>   | SCL "L" pulse width (Read)     | 60  |     | ns   |                           |
| D/CX      | T <sub>DCS</sub>   | D/CX setup time                | 10  |     | ns   |                           |
|           | T <sub>DCH</sub>   | D/CX hold time                 | 10  |     | ns   |                           |
| SDA (DIN) | T <sub>SDS</sub>   | Data setup time                | 10  |     | ns   |                           |
|           | T <sub>SDH</sub>   | Data hold time                 | 10  |     | ns   |                           |
| DOUT      | T <sub>ACC</sub>   | Access time                    | 10  | 50  | ns   | For maximum CL=30pF       |
|           | T <sub>OH</sub>    | Output disable time            | 15  | 50  | ns   | For minimum CL=8pF        |

Table 6 4-line serial Interface Characteristics

## RGB Interface Characteristics:

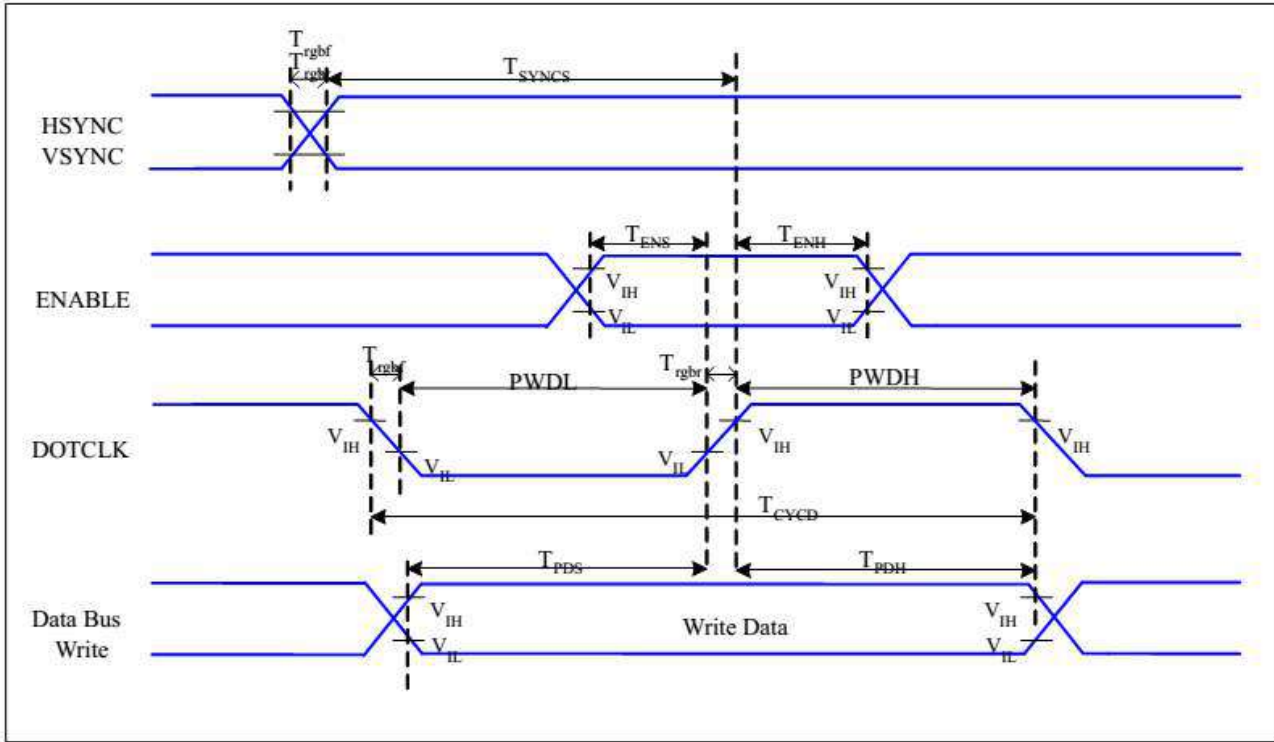

**Figure 6 RGB Interface Timing Characteristics**

*VDDI=1.65 to 3.3V, VDD=2.4 to 3.3V, AGND=DGND=0V, Ta=-30 ~ 70 °C*

| Signal       | Symbol       | Parameter                     | MIN | MAX | Unit | Description |
|--------------|--------------|-------------------------------|-----|-----|------|-------------|
| HSYNC, VSYNC | $T_{SYNCS}$  | VSYNC, HSYNC Setup Time       | 30  | -   | ns   |             |
| ENABLE       | $T_{ENS}$    | Enable Setup Time             | 25  | -   | ns   |             |
|              | $T_{ENH}$    | Enable Hold Time              | 25  | -   | ns   |             |
| DOTCLK       | PWDH         | DOTCLK High-level Pulse Width | 60  | -   | ns   |             |
|              | PWDL         | DOTCLK Low-level Pulse Width  | 60  | -   | ns   |             |
|              | $T_{CYCD}$   | DOTCLK Cycle Time             | 120 | -   | ns   |             |
|              | Trghr, Trghf | DOTCLK Rise/Fall time         | -   | 20  | ns   |             |
| DB           | $T_{PDS}$    | PD Data Setup Time            | 50  | -   | ns   |             |
|              | $T_{PDH}$    | PD Data Hold Time             | 50  | -   | ns   |             |

**Table 7 18/16 Bits RGB Interface Timing Characteristics**



# 9. POWER SEQUENCE

VDDI and VDD can be applied in any order.

VDD and VDDI can be power down in any order.

During power off, if LCD is in the Sleep Out mode, VDD and VDDI must be powered down minimum 120msec after RESX has been released.

During power off, if LCD is in the Sleep In mode, VDDI or VDD can be powered down minimum 0msec after RESX has been released.

CSX can be applied at any timing or can be permanently grounded. RESX has priority over CSX.

*Note 1: There will be no damage to the display module if the power sequences are not met.*

*Note 2: There will be no abnormal visible effects on the display panel during the Power On/Off Sequences.*

*Note 3: There will be no abnormal visible effects on the display between end of Power On Sequence and before receiving Sleep Out command. Also between receiving Sleep In command and Power Off Sequence.*

*Note 4: If RESX line is not held stable by host during Power On Sequence as defined in the sequence below, then it will be necessary to apply a Hardware Reset (RESX) after Host Power On Sequence is complete to ensure correct operation. Otherwise function is not guaranteed.*

The power on/off sequence is illustrated below

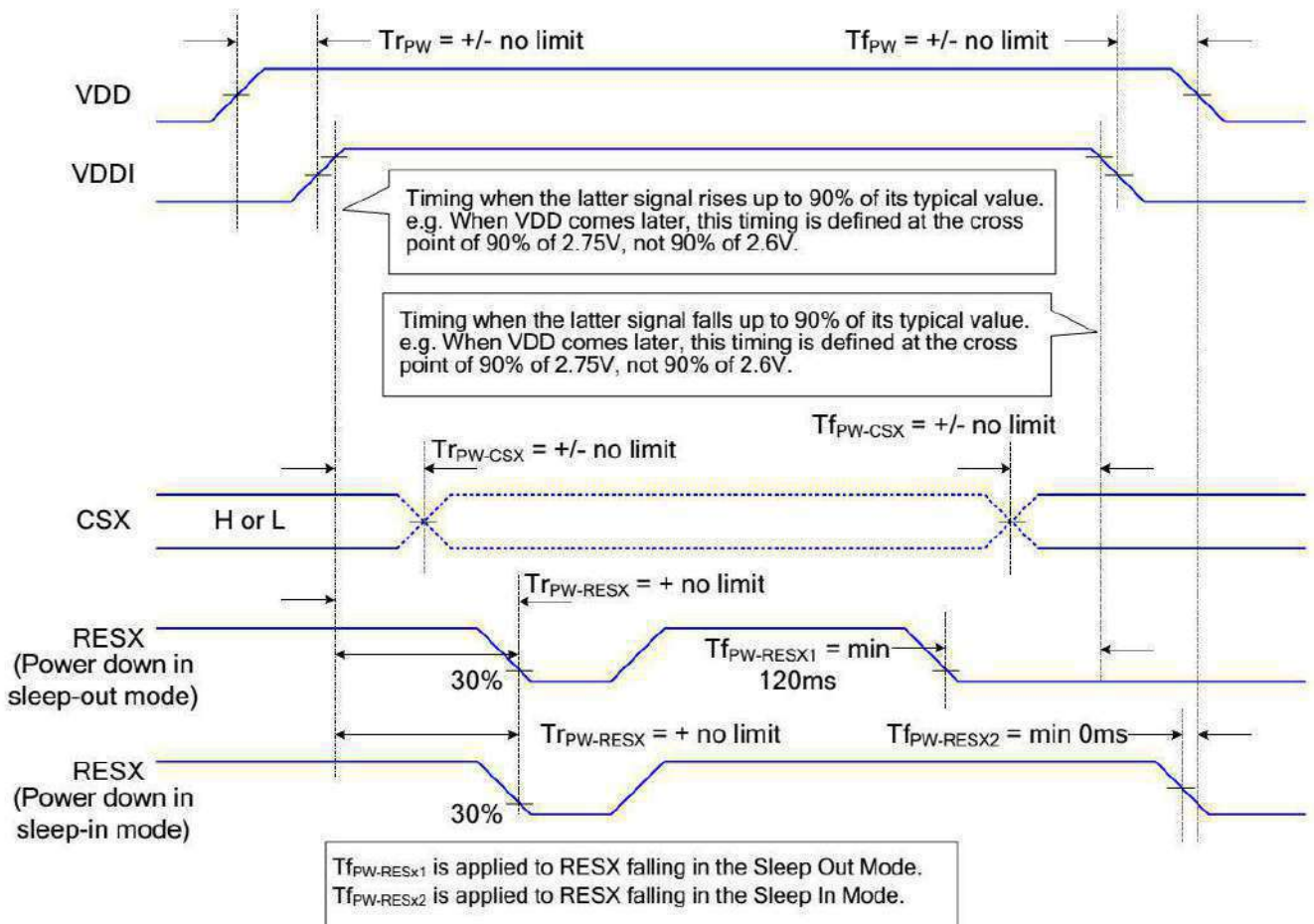

## 10. RELIABILITY TEST CONDITIONS

| No.                                                                                                                                                                                                                                                                                                                                                                                                                                                                                                                                                                                                                                                                                                                            | Test item                           | Test condition                                                 | Inspection after test                                                                                                                                                                                                                                                                                                                   |                 |
|--------------------------------------------------------------------------------------------------------------------------------------------------------------------------------------------------------------------------------------------------------------------------------------------------------------------------------------------------------------------------------------------------------------------------------------------------------------------------------------------------------------------------------------------------------------------------------------------------------------------------------------------------------------------------------------------------------------------------------|-------------------------------------|----------------------------------------------------------------|-----------------------------------------------------------------------------------------------------------------------------------------------------------------------------------------------------------------------------------------------------------------------------------------------------------------------------------------|-----------------|
| 10.1                                                                                                                                                                                                                                                                                                                                                                                                                                                                                                                                                                                                                                                                                                                           | High temperature storage test       | +80°C/240 hours                                                | Inspection after 2~4hours storage at room temperature, the sample shall be free from defects :<br>1.Current changing value before test and after test is 50% larger;<br>2. Function defect : Non-display,abnormal-d isplay,missing lines, Short lines,I TO corrosion;<br>3.Visual defect : Air bubble in the LCD,Seal leak,Glass crack. |                 |
| 10.2                                                                                                                                                                                                                                                                                                                                                                                                                                                                                                                                                                                                                                                                                                                           | Low temperature storage test        | -30°C/240 hours                                                |                                                                                                                                                                                                                                                                                                                                         |                 |
| 10.3                                                                                                                                                                                                                                                                                                                                                                                                                                                                                                                                                                                                                                                                                                                           | High temperature operating test     | +70°C/120 hours                                                |                                                                                                                                                                                                                                                                                                                                         |                 |
| 10.4                                                                                                                                                                                                                                                                                                                                                                                                                                                                                                                                                                                                                                                                                                                           | Low temperature operating test      | -20°C/120 hours                                                |                                                                                                                                                                                                                                                                                                                                         |                 |
| 10.5                                                                                                                                                                                                                                                                                                                                                                                                                                                                                                                                                                                                                                                                                                                           | Temperature cycle storage test      | -30°C ~ 25°C ~ +80°C/10cycles (30min.) (10min.) (30min.)       |                                                                                                                                                                                                                                                                                                                                         |                 |
| 10.6                                                                                                                                                                                                                                                                                                                                                                                                                                                                                                                                                                                                                                                                                                                           | High temperature high humidity test | +50°C*90% RH/120 hours                                         |                                                                                                                                                                                                                                                                                                                                         |                 |
| 10.7                                                                                                                                                                                                                                                                                                                                                                                                                                                                                                                                                                                                                                                                                                                           | Vibration test                      | Frequency : 250 r/min<br>Amplitude : 1 inch<br>Time: 45min     |                                                                                                                                                                                                                                                                                                                                         |                 |
| 10.8                                                                                                                                                                                                                                                                                                                                                                                                                                                                                                                                                                                                                                                                                                                           | Drop test                           | Drop direction:<br>1 corner/3 edges/6 sides 10 time            |                                                                                                                                                                                                                                                                                                                                         |                 |
|                                                                                                                                                                                                                                                                                                                                                                                                                                                                                                                                                                                                                                                                                                                                |                                     | Packing weight(kg)                                             |                                                                                                                                                                                                                                                                                                                                         | Drop height(cm) |
|                                                                                                                                                                                                                                                                                                                                                                                                                                                                                                                                                                                                                                                                                                                                |                                     | <11                                                            |                                                                                                                                                                                                                                                                                                                                         | 80±1.6          |
|                                                                                                                                                                                                                                                                                                                                                                                                                                                                                                                                                                                                                                                                                                                                |                                     | 11≤G<21                                                        | 60±1.2                                                                                                                                                                                                                                                                                                                                  |                 |
|                                                                                                                                                                                                                                                                                                                                                                                                                                                                                                                                                                                                                                                                                                                                |                                     | 21≤G<31                                                        | 50±1.0                                                                                                                                                                                                                                                                                                                                  |                 |
|                                                                                                                                                                                                                                                                                                                                                                                                                                                                                                                                                                                                                                                                                                                                |                                     | 31≤G<40                                                        | 40±0.8                                                                                                                                                                                                                                                                                                                                  |                 |
| 10.9                                                                                                                                                                                                                                                                                                                                                                                                                                                                                                                                                                                                                                                                                                                           | ESD test                            | Air discharge: ±8KV, 10time<br>Contact discharge: ±4KV, 10time |                                                                                                                                                                                                                                                                                                                                         |                 |
| Remark :<br>1.The test samples should be applied to only one test item.<br>2.Sample size for each test item is 3~5pcs.<br>3.For High temperature high humidity test, Pure water(Resistance>10MΩ) should be used.<br>4.In case of malfunction defect caused by ESD damage, if it would be recovered to normal state after resetting, it would be judged as a good part.<br>5.B/L evaluation should be excepted from reliability test with humidity and temperature: Some defects such as black spot/blemish can happen by natural chemical reaction with humidity and Fluorescence B/L has.<br>6.Failure judgment criterion: Basic specification, Electrical characteristic, Mechanical characteristic, Optical characteristic. |                                     |                                                                |                                                                                                                                                                                                                                                                                                                                         |                 |



# 11.INSPECTION CRITERION

## 11.1. Objective

The TFT test criterion are set to formalize TFT quality standards for ODNA with reference to those of the customer for inspection, release and acceptance of finished TFT products in order to guarantee the quality of TFT products required by the customer.

## 11.2. Scope

The criterion is applicable to all the TFT products manufactured by ODNA.

## 11.3. Equipment for Inspection

Electrical tester, electrical testing machines, vernier calipers, microscopes, magnifiers, anti-static wrist straps, finger cots, labels, tri-phase cold and hot shock machine, constant temperature and humidity chamber, backlight table, ovens for high-low temperature experiments, refrigerators, constant voltage power supply (DC) ) , desk Lamps, etc.

## 11.4. Sampling Plan and Reference Standards

11.4.1.1 Sampling plan:

Refer to National Standard GB/T 2828.1---2012/ISO2859-1:1999, level II of normal levels:

| Product Category | Consumer Electronics | Non-consumer Electronics | Industrial      | Automobile      |
|------------------|----------------------|--------------------------|-----------------|-----------------|
| AQL              | MA=0.4 MI=1.5        | MA=0.4 MI=1.0            | MA=0.25 MI=0.65 | MA=0.15 MI=0.40 |

11.4.1.2 GB/T 2828.1---2012/ISO2859-1:1999 Sampling check procedure in count

11.4.1.3 GB/T 18910. Standard for LCM parts

11.4.1.4 GB/T24213-2008 Basic Environmental Test Procedures for Electrical and Electronic Products

11.4.1.5 IPC-A-610E Acceptability of Electronic Assemblies

## 11.5. Inspection Conditions and Inspection Reference

11.5.1 Cosmetic inspection: shall be done normally at  $23 \pm 5^{\circ}\text{C}$  of the ambient temperature and  $45\sim 75\% \text{RH}$  of relative humidity, under the ambient luminance between 500lux~1000lux and at the distance of 30cm apart between the inspector's eyes and the LCD panel and normally in reflected light. For backlight LCM, cosmetic inspection shall be done under the ambient luminance less than 100lux with the backlight on.

11.5.2 The TFT shall be tested at the angle of  $45^{\circ}$  left and right and  $0-45^{\circ}$  top and bottom as the following picture showing:

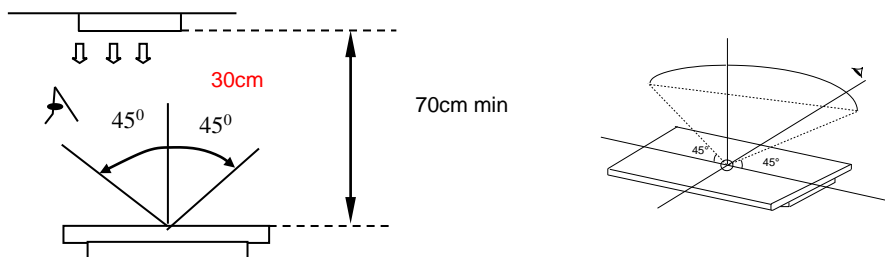

### 11.5.3 Definition of viewing area (VA)

A area: Active area (AA area)

B area: Viewing area (VA area)

C area: Non-viewing area (not viewing after customer assembly)

If there is any appearance viewing defect which do not affect product quality and customer assembly in C area, it's accepted in generally.

The criteria apply to A and B area except chipping and crack.

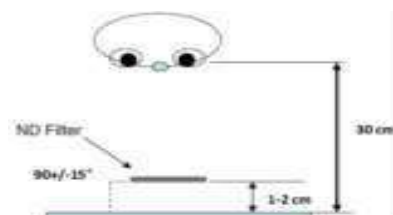
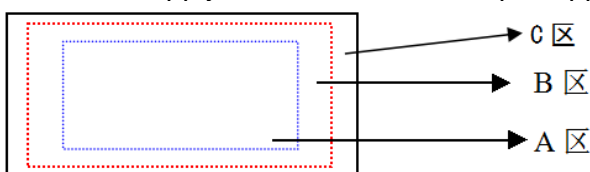

11.5.4 Inspection with naked eyes(exclusive of the inspection of the physical dimensions of defects carried out with magnifiers)

11.5.5 ND card use method(refer to right conner image ) and scope: Multi-bright dot; Mura(Black/Gray pattern uneven); dark line and so on.

11.5.6 Undefined items or other special items, refer to mutual agreement and limited sample. If criterion does not match product specifications/ technical requirement, both should be subject to special inspection criterion agreed by customer.





**11.6 Defects and Acceptance Standards**

11.6.1 Electrical properties test

11.6.1.1 Test voltage(V): Refer to the instruction of testers and the product specification or drawing and the display content and parameters and display effects shall conform to the product specification and drawing.

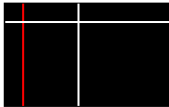
11.6.1.2 Current Consumption(I): Refer to approved product specifications or drawings.

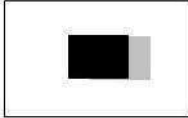
11.6.1.3 Function items(Defect category MA)

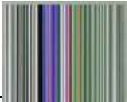
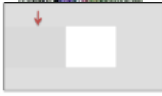
| No.         | Defects                    | Descriptions                                                                                         | Pictures                                                                             | Inspection method/tools         | Defect category |
|-------------|----------------------------|------------------------------------------------------------------------------------------------------|--------------------------------------------------------------------------------------|---------------------------------|-----------------|
| 11.6.1.3.1  | No display /reaction       | shows no picture/display in normal connected situation.                                              |    | Naked eyes/ testers             | MA              |
| 11.6.1.3.2  | Missing segment            | Shows missing lines in normal display                                                                |    | Naked eyes/ testers             | MA              |
| 11.6.1.3.3  | Dark line                  | Only visible on gray pattern, 1 or more vertical/horizontal lines: 5%ND, not visible, OK             | /                                                                                    | Naked eyes/ testers             | MA              |
| 11.6.1.3.4  | POL angle defect           | Not accepted                                                                                         |  | Naked eyes/ testers             | MA              |
| 11.6.1.3.5  | Image retention (sticking) | Chess pattern stays for 30mins and change to 50% gray pattern, disappear in 10s, OK; if time>10s, NG |  | Naked eyes/ testers             | MA              |
| 11.6.1.3.6  | Flicker                    | Refer to Limit sample if essential or flicker value <-30dB (measured by CA310A); OK                  |   | Naked eyes/ CA310A              | MA              |
| 11.6.1.3.7  | Display abnormal           | Not accepted                                                                                         |  | Naked eyes/ testers             | MA              |
| 11.6.1.3.8  | Cross-talk                 | Refer to limited sample                                                                              |  | Naked eyes/ limited sample      | MA              |
| 11.6.1.3.9  | Display dim/bright         | Refer to limited sample                                                                              | /                                                                                    | Naked eyes/ limited sample      | MA              |
| 11.6.1.3.10 | Contrast                   | Refer to limited sample                                                                              | /                                                                                    | Naked eyes/ limited sample      | MA              |
| 11.6.1.3.11 | Huge current               | Out of spec, not accepted                                                                            | /                                                                                    | Ammeter                         | MA              |
| 11.6.1.3.12 | TP function defect         | Not accepted                                                                                         | /                                                                                    | Naked eyes/ Touch/ test program | MA              |

11.6.2 LCD dot/line defect

11.6.2.1 LCD pixel dot defect(defect category: MI)

| Item                                                                                                       | Inspection criterion |        |             |              |
|------------------------------------------------------------------------------------------------------------|----------------------|--------|-------------|--------------|
|                                                                                                            | Size                 | S < 5" | 5 ≤ S < 10" | 10 ≤ S < 15" |
| Color pixel dot defect(RGB dot)                                                                            | 1                    | 2      | 2           | 3            |
| 2 connected bright dot                                                                                     | 0                    | 1      | 1           | 1            |
| 3 connected bright dot or more                                                                             | 0                    | 0      | 1           | 0            |
| Bright dot quantity                                                                                        | 1                    | 2      | 3           | 4            |
| Random dark dot quantity                                                                                   | 2                    | 3      | 4           | 5            |
| 2 connected dark dot                                                                                       | 1                    | 1      | 2           | 2            |
| 3 connected dark dot or more                                                                               | 0                    | 0      | 0           | 0            |
| Dark dot quantity                                                                                          | 3                    | 4      | 5           | 6            |
| Multi-bright dot                                                                                           | ND 5% hidden, OK     |        |             |              |
| Remark: 2 bright dots distance DS ≥ 15mm 2 dark dots distance DS ≥ 5mm                                     |                      |        |             |              |
| 1) Bright dot: Power on TFT and RGB dot in black display                                                   |                      |        |             |              |
| 2) Dark dot: Power on TFT and gray or black dot in RGB display                                             |                      |        |             |              |
| 3) Multi-bright dot: Power on TFT and fluorescent tiny dot in black display(only visible in black display) |                      |        |             |              |

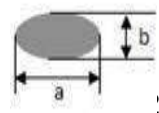
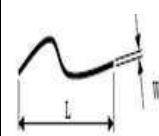

11.6.2.2 LCD appearance dot defect (defect category: MI)

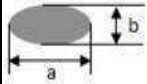
| No.                                                                                                                                                                            | Item                                | Inspection criterion                                                                                                                                  |                 |             |                    |                   |                                                                                       | Picture                                                                               | Inspection method/tools          |
|--------------------------------------------------------------------------------------------------------------------------------------------------------------------------------|-------------------------------------|-------------------------------------------------------------------------------------------------------------------------------------------------------|-----------------|-------------|--------------------|-------------------|---------------------------------------------------------------------------------------|---------------------------------------------------------------------------------------|----------------------------------|
|                                                                                                                                                                                |                                     | Size                                                                                                                                                  | S < 5"          | 5 ≤ S < 10" | 10 ≤ S < 15"       | S ≥ 15"           |                                                                                       |                                                                                       |                                  |
| 11.6.2.2.1                                                                                                                                                                     | Dot defect (black dot, white dot)   | D ≤ 0.15                                                                                                                                              | ignore          | ignore      | D ≤ 0.2; Not count | D ≤ 0.2; ignore   |  | Naked eyes /film card /magnifier                                                      |                                  |
|                                                                                                                                                                                |                                     | 0.15 < D ≤ 0.25                                                                                                                                       | 3               | 3           |                    |                   |                                                                                       |                                                                                       |                                  |
|                                                                                                                                                                                |                                     | 0.25 < D ≤ 0.30                                                                                                                                       | 1               | 2           | 0.2~0.35 Q'ty ≤ 4  | 0.2~0.35 Q'ty ≤ 5 |                                                                                       |                                                                                       |                                  |
|                                                                                                                                                                                |                                     | 0.30 < D ≤ 0.35                                                                                                                                       | 0               | 1           |                    |                   |                                                                                       |                                                                                       |                                  |
|                                                                                                                                                                                |                                     | 0.35 < D ≤ 0.50                                                                                                                                       | 0               | 0           | 1                  | 2                 |                                                                                       |                                                                                       |                                  |
|                                                                                                                                                                                |                                     | D > 0.5                                                                                                                                               | 0               | 0           | 0                  | 0                 |                                                                                       |                                                                                       |                                  |
|                                                                                                                                                                                |                                     | Remark: D ≤ 0.15mm, not count. Multi-dot as bulk is not accepted. Count dot quantity ≤ 5; 2 round dots or linear dots in 1 cm is judged as multi-dot. |                 |             |                    |                   |                                                                                       |                                                                                       |                                  |
| 11.6.2.2.2                                                                                                                                                                     | Line defect (visible when power on) | Length (mm)                                                                                                                                           | Width (mm)      | S < 5"      | 5 ≤ S < 10"        | 10 ≤ S < 15"      | S ≥ 15"                                                                               |  | Naked eyes /film card /magnifier |
|                                                                                                                                                                                |                                     | Not count                                                                                                                                             | W ≤ 0.03        | Ignored     | Ignored            | Ignored           | Ignored                                                                               |                                                                                       |                                  |
|                                                                                                                                                                                |                                     | L ≤ 5                                                                                                                                                 | 0.03 ≤ W < 0.05 | 3           | 3                  | Ignored           | Ignored                                                                               |                                                                                       |                                  |
|                                                                                                                                                                                |                                     | L ≤ 5                                                                                                                                                 | 0.05 ≤ W < 0.08 | 0           | 1                  | 3                 | 3                                                                                     |                                                                                       |                                  |
|                                                                                                                                                                                |                                     | L ≤ 8                                                                                                                                                 | 0.05 ≤ W < 0.08 | 0           | 0                  | 1                 | 2                                                                                     |                                                                                       |                                  |
|                                                                                                                                                                                |                                     | L > 8                                                                                                                                                 | W > 0.08        | 0           | 0                  | 0                 | 0                                                                                     |                                                                                       |                                  |
| Remark: Invisible when power on, only visible in special angle against light, show as watermark/folding/scratch but can not be touched, no control or refer to keeping sample. |                                     |                                                                                                                                                       |                 |             |                    |                   |                                                                                       |                                                                                       |                                  |

|            |                                                              |                     |           |                   |                    |               |                                                                                     |                                        |
|------------|--------------------------------------------------------------|---------------------|-----------|-------------------|--------------------|---------------|-------------------------------------------------------------------------------------|----------------------------------------|
| 11.6.2.2.3 | Polarizer convex-concave dot defect, polarizer bubble defect | Size(mm)            | $S < 5''$ | $5 \leq S < 10''$ | $10 \leq S < 15''$ | $S \geq 15''$ |  | Naked eyes<br>/film card<br>/magnifier |
|            |                                                              | $D \leq 0.20$       | Ignored   | Ignored           | Ignored            | Ignored       |                                                                                     |                                        |
|            |                                                              | $0.20 < D \leq 0.5$ | 2         | 2                 | 3                  | 5             |                                                                                     |                                        |
|            |                                                              | $0.50 < D \leq 0.8$ | 0         | 1                 | 2                  | 3             |                                                                                     |                                        |
|            |                                                              | $0.8 < D \leq 1.5$  | 0         | 0                 | 1                  | 2             |                                                                                     |                                        |
|            |                                                              | $D > 1.5mm$         | 0         | 0                 | 0                  | 0             |                                                                                     |                                        |

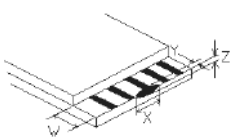
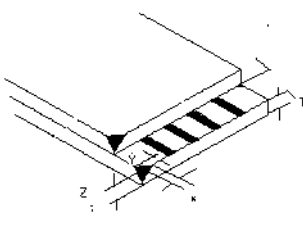
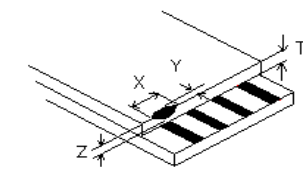
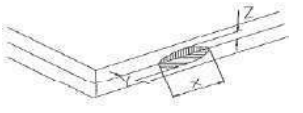
### 11.6.3 Chipping defect

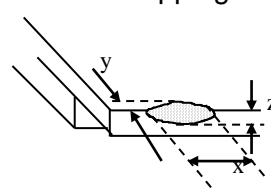
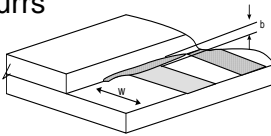
| No.      | Item                                                                                                                                                                                                                                                                                                                            | Accepted criterion(mm) |                        |                      |            | MAJ | MIN |
|----------|---------------------------------------------------------------------------------------------------------------------------------------------------------------------------------------------------------------------------------------------------------------------------------------------------------------------------------|------------------------|------------------------|----------------------|------------|-----|-----|
| 11.6.3.1 | <br>ITO conductive side                                                                                                                                                                                                                        | X                      | /                      | $\leq 1/8L$          | /          |     | √   |
|          |                                                                                                                                                                                                                                                                                                                                 | Y                      | $Y \leq 1/6W$          | $1/6W < Y \leq 1/4W$ | $1/4W < Y$ |     |     |
|          |                                                                                                                                                                                                                                                                                                                                 | Accept                 | 2                      | 2                    | 0          |     |     |
| 11.6.3.2 | Corner chipping<br>(ITOpins position)                                                                                                                                                                                                                                                                                           | X                      | /                      | $\leq 1/6L$          | /          |     | √   |
|          |                                                                                                                                                                                                                                                                                                                                 | Y                      | $Y \leq 1/2W$          | $1/2W < Y \leq W$    | $W < Y$    |     |     |
|          | <br>Accept 2 1 0<br>Corner chipping occurred in sealed edge position as per 6.3.3; at the same time it should not enter into black border of the frame and the corner chipping effect the electric connection position perform as per 6.3.1. |                        |                        |                      |            |     |     |
| 11.6.3.3 | Chipping in sealed area<br>(outside chipping)<br><br>Chipping in sealed area<br>(inside chipping)<br>                                                     | X                      | /                      | $\leq 1/8L$          | /          |     | √   |
|          |                                                                                                                                                                                                                                                                                                                                 | Y (outside chipping)   | Not enter into sealant | Enter $Y \leq H$     | $H < Y$    |     |     |
|          |                                                                                                                                                                                                                                                                                                                                 | Y (inside chipping)    |                        | Enter $Y \leq 1/2H$  | $1/2H < Y$ |     |     |
|          |                                                                                                                                                                                                                                                                                                                                 | Z                      | $\leq T$               | $\leq 1/2T$          | /          |     |     |
|          |                                                                                                                                                                                                                                                                                                                                 | Accept                 | 2                      | 1                    | 0          |     |     |
|          | The standards of inner and outer chipping on edge sealing area are same. When the chipping occurred in the opposite of stage, Y as per the chipping on the non-conduction side standard in 6.3.1                                                                                                                                |                        |                        |                      |            |     |     |
| 11.6.3.4 | conductive side                                                                                                                                                                                                                                                                                                                 | X                      | /                      | $\leq 1/6L$          | /          |     | √   |

|                                                                                                                                                                                                                         |                                                                                                                                      |                                                                                                                                             |               |                      |            |  |   |
|-------------------------------------------------------------------------------------------------------------------------------------------------------------------------------------------------------------------------|--------------------------------------------------------------------------------------------------------------------------------------|---------------------------------------------------------------------------------------------------------------------------------------------|---------------|----------------------|------------|--|---|
|                                                                                                                                                                                                                         | (back side chipping<br>                             | Y                                                                                                                                           | $Y \leq 1/3W$ | $1/3W < Y \leq 2/3W$ | $2/3W < Y$ |  |   |
|                                                                                                                                                                                                                         |                                                                                                                                      | Accept                                                                                                                                      | 2             | 2                    | 0          |  |   |
|                                                                                                                                                                                                                         |                                                                                                                                      | Chipping into ITO side ,refer to 6.3.1                                                                                                      |               |                      |            |  |   |
| 11.6.3.5                                                                                                                                                                                                                | Protruding LCD<br>poor cutting and LCD<br>burrs<br> | X                                                                                                                                           | /             | $\leq 1/8L$          | /          |  | √ |
|                                                                                                                                                                                                                         |                                                                                                                                      | Y                                                                                                                                           | $\leq 1/6W$   | $1/6W < Y \leq 1/5W$ | $1/5W < Y$ |  |   |
|                                                                                                                                                                                                                         |                                                                                                                                      | Z                                                                                                                                           | /             | /                    | /          |  |   |
|                                                                                                                                                                                                                         |                                                                                                                                      | Accept                                                                                                                                      | 1             | 1                    | 1          |  |   |
|                                                                                                                                                                                                                         |                                                                                                                                      | the outside protruding control as per the tolerance of drawing.                                                                             |               |                      |            |  |   |
| 11.6.3.6                                                                                                                                                                                                                | Crack<br>                                           | Not allow to occur cracks without direction; the crack expand to inside is NG, but to outside is OK (confirmed as per the damaged standard) |               |                      |            |  | √ |
| Remark:1)X means the length of chipping; Y means the width; Z means the thickness; W means the step width of the two glasses; H means the distance from the glass edge to the seal inner edge; t means glass thickness. |                                                                                                                                      |                                                                                                                                             |               |                      |            |  |   |

#### 11.6.4 Backlight components

| No.      | Item                        | Description                                                                                                                                                                                                       | Accepted criterion           | MAJ | MIN |
|----------|-----------------------------|-------------------------------------------------------------------------------------------------------------------------------------------------------------------------------------------------------------------|------------------------------|-----|-----|
| 11.6.4.1 | No backlight<br>wrong Color | /                                                                                                                                                                                                                 | Rejected                     | √   |     |
| 11.6.4.2 | Color<br>deviation          | When powered on, the LCD color differs from its sample and found that the color not conforming to the drawing after testing.                                                                                      | Refer to sample and drawing. |     | √   |
| 11.6.4.3 | Brightness<br>deviation     | When powered on, the LCD brightness differs from its sample and is found after testing not conforming to the drawing; or if it conforms to the drawing but the brightness over $\pm 40\%$ than its typical value. | Refer to sample and drawing. |     | √   |
| 11.6.4.4 | Uneven<br>brightness        | Uneven on the same LCD and out of the specification of the drawing. The no specification evenness= (the max value-the min value)/ mean value $< 70\%$ .                                                           | Refer to sample and drawing. |     | √   |
| 11.6.4.5 | Spot/line<br>/scratch       | When power on, it has dirty spot, scratches and so on spot and line defects.                                                                                                                                      | Refer to 6.2.2               |     | √   |

11.6.5 Metal frame (Metal Bezel)

| No.      | Item                                                | Description                                                                                                                                                                                                                                                                     | Accepted criterion | MAJ | MIN |
|----------|-----------------------------------------------------|---------------------------------------------------------------------------------------------------------------------------------------------------------------------------------------------------------------------------------------------------------------------------------|--------------------|-----|-----|
| 11.6.5.1 | Material & surface treatment                        | Metal frame/surface treatment do not conform to the specifications.                                                                                                                                                                                                             | Rejected           | √   |     |
| 11.6.5.2 | Tab twist<br>Unconformity/<br>Tab not twisted       | Wrong twist method or direction and twist tabs are not twisted as required.                                                                                                                                                                                                     | Rejected           | √   |     |
| 11.6.5.3 | Bezel paint loss                                    | 1.Front surface:<br>Paint peel off and scratch to the bottom<br>Dot:D≤0.5mm, exceeds 3;<br>Line:L≤3.0mm,W≤0.05mm exceeds 2;<br>2.Front dent, air bubble and side with paint peeling off scratch to the bottom<br>Dot: D≤1.0mm, exceeds 3;<br>Line:L≤10.0mm,W≤0.05mm, exceeds 2; | Rejected           |     | √   |
| 11.6.5.4 | Bezel scratch                                       |                                                                                                                                                                                                                                                                                 |                    |     | √   |
| 11.6.5.5 | Painting peel off, discoloration, dent, and scratch |                                                                                                                                                                                                                                                                                 |                    |     | √   |
| 11.6.5.6 | Burr                                                | Burr(s) on metal bezel is so long as to get into viewing area.                                                                                                                                                                                                                  | Rejected           |     | √   |

11.6.6 FPC

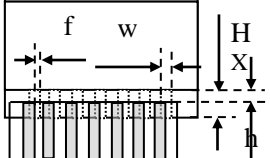
| No.      | Item                     | Description                                                                                                                                                                              | Accepted criterion                                                                                                                                                                   | MAJ | MIN |
|----------|--------------------------|------------------------------------------------------------------------------------------------------------------------------------------------------------------------------------------|--------------------------------------------------------------------------------------------------------------------------------------------------------------------------------------|-----|-----|
| 11.6.6.1 | Model & P/N              | Material model & P/N                                                                                                                                                                     | Keep the same with drawing and technical requirement                                                                                                                                 | √   |     |
| 11.6.6.2 | Dimension/<br>position   | <p>Dimension in drawing spec</p>  <p>Remark: H=ITO pin length<br/>f=FPC width<br/>W=ITO pin width</p> | $f \leq 1/3w$ , $h \leq 1/3H$ , dimension in drawing spec-> OK<br>Conductive material and ITO/PDA connective area must over than 1/2.<br>Entire dimension must be in spec tolerance. |     | √   |
| 11.6.6.3 | FPC appearance           | Hot pressing material get broken, folding line open; FPC golden finger oxidate, broken ,scratch ,foreign material which cause line short                                                 | Broken length<2mm; FPC line is OK-> Accepted<br>Crack and line broken-> Rejected                                                                                                     |     | √   |
| 11.6.6.4 | FPC burr                 | Burr near FPC edge area                                                                                                                                                                  | When cover line and burr length $\leq 1.0\text{mm}$ ->Accepted                                                                                                                       |     | √   |
| 11.6.6.5 | FPC falling off          | FPC bonding area falling off ; silica gel breaking                                                                                                                                       | Rejected                                                                                                                                                                             |     | √   |
| 11.6.6.6 | Sealant missing ITO line | Sealant is not covered all ITO line                                                                                                                                                      | Rejected                                                                                                                                                                             | √   |     |
| 11.6.6.7 | Missing sealant          | No sealant                                                                                                                                                                               | Rejected                                                                                                                                                                             | √   |     |
| 11.6.6.8 | Sealant                  | Sealant height > product total height                                                                                                                                                    | Rejected                                                                                                                                                                             | √   |     |

11.6.7 SMT

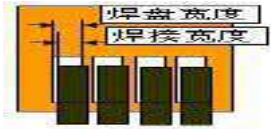
| No.      | Item                      | Description                                                                                                                      | Accepted criterion | MAJ | MIN |
|----------|---------------------------|----------------------------------------------------------------------------------------------------------------------------------|--------------------|-----|-----|
| 11.6.7.1 | Soldering bridge          | Solder between adjacent pads and components<br> | Rejected           |     | √   |
| 11.6.7.2 | Solder ball/splash        | Solder ball/tin dross causing short circuit at the solder point. There are active solder ball and splash.                        | Rejected           |     | √   |
| 11.6.7.3 | Soldering excursion       | Soldering slant > 1/3 soldering pad<br>         | Rejected           |     | √   |
| 11.6.7.4 | Component wrong attaching | Component on PCB differs with drawing: wrong one, extra one, lack one, opposite polarity                                         | Rejected           | √   |     |
|          |                           | JUMP short circuit on PCB: extra soldering ,lack soldering.                                                                      | Rejected           | √   |     |
| 11.6.7.5 | Component falling off     | Soldering but component is missing                                                                                               | Rejected           | √   |     |
| 11.6.7.6 | Wrong component           | Component model/spec differs from product specification                                                                          | Rejected           | √   |     |

11.6.8 General Appearance

| No.      | Item                      | Description                                                                           | Accepted criterion                                          | MAJ | MIN |
|----------|---------------------------|---------------------------------------------------------------------------------------|-------------------------------------------------------------|-----|-----|
| 11.6.8.1 | Dimension                 | According to drawing                                                                  | Accepted                                                    | √   |     |
| 11.6.8.2 | Surface stain             | Defect mark or label are not removed residual glue, and finger print,etc;             | Rejected                                                    |     | √   |
| 11.6.8.3 | Assembly foreign material | Dot/linear stain after assembly backlight and diffuse film<br>TP assembly foggy stain | Invisible when power on->OK<br>Refer to 6.2.2 dot/line spec |     | √   |
| 11.6.8.4 | Mixture                   | Different model product in the same shipment                                          | Rejected                                                    | √   |     |
| 11.6.8.5 | Product mark              | Missing, unclear, incorrect, or misplaced part                                        | Rejected                                                    |     | √   |
| 11.6.8.6 | Component mark            | Silk screen mark clear, resistance measured value in spec                             | Accepted<br>(Refer to customer special requirement)         |     | √   |
| 11.6.8.7 | Newton's rings            | Area<1/6 screen area quantity≤1                                                       | Accepted                                                    |     | √   |

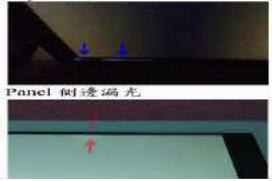
|           |            |                                                                                                                                                                   |                                                                                                                |  |   |
|-----------|------------|-------------------------------------------------------------------------------------------------------------------------------------------------------------------|----------------------------------------------------------------------------------------------------------------|--|---|
| 11.6.8.8  | Mura       | 1.In black display<br>ND 5% invisible ->OK; visible->NG<br>2.Naked eyes inspection<br>RGB display invisible<br>Black display, area<1/4 screen area                | Refer to limited sample<br> |  | √ |
| 11.6.8.9  | Light leak | 1.LCD edge(near backlight) shadow by LCD lamps irregular illuminate<br>2.Judge in black/white/gray display (slight leaky is yellowish, greenish, bluefish ->NG) ; | Refer to limited sample<br> |  | √ |
| 11.6.8.10 | Polarizer  | 1.Polarizer slant.Cover VA and not over LCD edge<br>2.No unmovable stain or finger print in polarizer VA<br>3.Bubble/warped but not enter VA                      | Accepted                                                                                                       |  | √ |
| 11.6.8.11 | TP defect  | 1.TP crack<br>2.TP stain(fogy&unremovable)<br>3.TP glue overflow to VA                                                                                            | Rejected                                                                                                       |  | √ |

Remark: Anything which is not clearly defined in 6.5~6.8 should refer to IPC-A-610E.Consumer Electronics, Non-consumer Electronics refer to class 1 and Industrial, Automobile refer to Class 2.

### 11.7. Others

Items not specified in this document or released on compromise should be inspected with reference to mutual agreement and limit samples.

## 12. HANDLING PRECAUTIONS

### 12.1 Mounting method

The LCD module consists of two thin glass plates with polarizes which easily be damaged. And since the module in so constructed as to be fixed by utilizing fitting holes in the printed circuit board.

Extreme care should be needed when handling the LCD modules.

### 12.2 Caution of LCD handling and cleaning

When cleaning the display surface, Use soft cloth with solvent [recommended below] and wipe lightly :

- .Isopropyl alcohol
- .Ethyl alcohol

Do not wipe the display surface with dry or hard materials that will damage the polarizer surface.

Do not use the following solvent :

- .Water
- .Aromatics

Do not wipe ITO pad area with the dry or hard materials that will damage the ITO patterns

Do not use the following solvent on the pad or prevent it from being contaminated :

- .Soldering flux
- .Chlorine (Cl) , Sulfur (S)

If goods were sent without being silicon coated on the pad, ITO patterns could be damaged due to the corrosion as time goes on.

If ITO corrosion happen by miss-handling or using some materials such as Chlorine (Cl), Sulfur (S) from customer, Responsibility is on customer.

### 12.3 Caution against static charge

The LCD module use C-MOS LSI drivers, so we recommended that you :

Connect any unused input terminal to Vdd or Vss, do not input any signals before power is turned on, and ground your body, work/assembly areas, assembly equipment to protect against static electricity.



## 12.4 Packing

Module employ LCD elements and must be treated as such.

- .Avoid intense shock and falls from a height.
- .To prevent modules from degradation, do not operate or store them exposed direct to sunshine or high temperature/humidity.

## 12.5 Caution for operation

- .It is an indispensable condition to drive LCD's within the specified voltage limit since the higher voltage then the limit cause the shorter LCD life.
- .An electrochemical reaction due to direct current causes LCD's undesirable deterioration, so that the use of direct current drive should be avoided.
- .Response time will be extremely delayed at lower temperature then the operating temperature range and on the other hand at higher temperature LCD's how dark color in them. However those phenomena do not mean malfunction or out of order with LCD's, which will come back in the specified operation temperature.
- .If the display area is pushed hard during operation, some font will be abnormally displayed but it resumes normal condition after turning off once.
- .A slight dew depositing on terminals is a cause for electro-chemical reaction resulting in terminal open circuit.
- .Usage under the maximum operating temperature, 50%Rh or less is required.
- .When fixed patterns are displayed for a long time,remnant image is likely to occur.

## 12.6 Storage

In the case of storing for a long period of time for instance, for years for the purpose or replacement use, the following ways are recommended.

- .Storing in an ambient temperature 10°C to 30°C, and in a relative humidity of 45% to 75%. Don't expose to sunlight or fluorescent light.
- .Storing in a polyethylene bag with the opening sealed so as not to enter fresh air outside in it . And with no desiccant.
- .Placing in a dark place where neither exposure to direct sunlight nor light's keeping the storage temperature range.
- .Storing with no touch on polarizer surface by the anything else.

It is recommended to store them as they have been contained in the inner container at the time of delivery from us.

## 12.7 Safety

- .It is recommendable to crash damaged or unnecessary LCD's into pieces and wash off liquid crystal by either of solvents such as acetone and ethanol, which should be burned up later.
- .When any liquid leaked out of a damaged glass cell comes in contact with your hands, please wash it off well with soap and water.

## 13. PRECAUTION FOR USE

**13.1** A limit sample should be provided by the both parties on an occasion when the both parties agreed its necessity. Judgment by a limit sample shall take effect after the limit sample has been established and confirmed by the both parties.

**13.2** On the following occasions, the handing of problem should be decided through discussion and agreement between responsible of the both parties.

- .When a question is arisen in this specification.
- .When a new problem is arisen which is not specified in this specifications.
- .When an inspection specifications change or operating condition change in customer is reported to ODNA, and some problem is arisen in this specification due to the change.
- .When a new problem is arisen at the customer's operating set for sample evaluation in the customer site.

## 14. PACKING SPECIFICATION

Please consult our technical department for detail information.

## 15. INITIALIZATION CODE

```
WriteComm(0x11);
Delay(120); //Delay 120ms
//-----Display Setting-----//
WriteComm(0x36);
WriteData(0x00);
WriteComm(0x3a);
WriteData(0x66);
WriteComm(0x21);
//-----ST7789V Frame rate setting-----//
WriteComm(0xb2);
WriteData(0x0c);
WriteData(0x0c);
WriteData(0x00);
WriteData(0x33);
WriteData(0x33);
WriteComm(0xb7);
WriteData(0x75);
//-----ST7789V Power setting-----//
WriteComm(0xb0);
WriteData(0x11);
WriteComm(0xbb);
WriteData(0x13);
WriteComm(0xc0);
WriteData(0x2c);
WriteComm(0xc2);
WriteData(0x01);
WriteComm(0xc3);
WriteData(0x13);
WriteComm(0xc4);
WriteData(0x20);
WriteComm(0xc6);
WriteData(0x0f);
WriteComm(0xd0);
WriteData(0xa4);
WriteData(0xa1);
//-----ST7789V gamma setting-----//
WriteComm(0xE0);
WriteData(0x70);
WriteData(0x08);
WriteData(0x10);
WriteData(0x0D);
WriteData(0x0C);
WriteData(0x07);
WriteData(0x37);
WriteData(0x53);
WriteData(0x4C);
WriteData(0x39);
WriteData(0x15);
WriteData(0x15);
WriteData(0x2A);
WriteData(0x2D);

WriteComm(0xE1);
WriteData(0x70);
WriteData(0x0D);
WriteData(0x12);
WriteData(0x08);
WriteData(0x08);
WriteData(0x15);
```

WriteData(0x34);  
WriteData(0x34);  
WriteData(0x4A);  
WriteData(0x36);  
WriteData(0x12);  
WriteData(0x13);  
WriteData(0x2B);  
WriteData(0x2F);  
Delay(120);  
WriteComm(0x29);  
Delay(120);

## **15. HSF COMPLIANCE**

●.This products complies with ROHS 2011/65/EU and 2015/863/EU、 REACH 1907/2006/EC requirements, and the packaging complies with 94-62-EC.