



ORIENT DISPLAY

Your Total LCD Solution Provider

Specification for LCD Module

AFY1024600A0-7.0INTH-R

Revision D



A	Orient Display
FY	TFT Type
1024600	Resolution 1024 x 600
A0	Serial A0
7.0	7.0", Module Dimension 164.80 x 99.80 x 6.75 mm
I	IPS Display
N	Top: -20~+70°C; Tstr: -30~+80°C
T	Transmissive
H	High Brightness, 800 cd/m2
R	Resistive Touch Panel
/	Controller EK79001HN + EK73215BCGA Or Compatible
/	LVDS Interface



REVISION RECORD

REV NO.	REV DATE	CONTENTS	REMARKS
O	2019-11-28	First release	Preliminary
A	2020.2.12	CHANGED BACKLIGHT. Detia a pagel of 9.	
B	2020-03-16	Update EXTERNAL DIMENSIONS Detia a pagel of 6	
C	2020-04-10	Update Module power consumption AND LED power consumption Detia as pagel of 4	
D	2020-05-04	Update EXTERNAL DIMENSION in page 5	

CONTENTS

1. GENERAL INFORMATION.....	4
2. ABSOLUTE MAXIMUM RATINGS.....	4
3. ELECTRICAL CHARACTERISTICS.....	4
4. BACKLIGHT CHARACTERISTICS.....	4
5. EXTERNAL DIMENSIONS.....	5
6. ELECTRO-OPTICAL CHARACTERISTICS.....	6
7. INTERFACE DESCRIPTION.....	9
8. LVDS CHARACTERISTICS.....	10
9. POWER SEQUENCE.....	15
10. RELIABILITY TEST CONDITIONS.....	16
11. INSPECTION CRITERION.....	17
12. HANDLING PRECAUTIONS.....	17
13. PRECAUTION FOR USE.....	18
14. PACKING SPECIFICATION.....	18

1. GENERAL INFORMATION

No.	Item	Contents	Unit
1	LCD size	7.0 inch (Diagonal)	/
2	LCD type	IPS/NormallyBlack/TRANSMISSIVE(ANTI-GLARE)	/
3	Viewing direction(eye)	Free	/
4	Resolution(H*V)	1024*600 Pixels	/
5	Module size (L*W*H)	164.8*99.8*6.75	mm
6	Active area (L*W)	154.21*85.92	mm
7	Pixel pitch (L*W)	0.1506* 0.1432	mm
8	Interface type	LVDS Interface	/
9	Module power consumption	4.905	W
10	Back light type	White LED	/
11	Driver IC	EK79001HN+EK73215BCGA or compatible	/
12	Weight	TBD	g

2. ABSOLUTE MAXIMUM RATINGS

Item	Symbol	Min	Max	Unit
Power supply input voltage (LCM)	VDD	-0.5	5.0	V
Backlight current (normal temp.)	ILED	-	600	mA
Operation temperature	Top	-20	70	°C
Storage temperature	Tst	-30	80	°C
Humidity	RH	-	90%(Max60°)	RH

3. ELECTRICAL CHARACTERISTICS

DC CHARACTERISTICS (at Ta=25°C)

Item	Symbol	Min	Typ	Max	Unit	Note
Power supply input voltage (LCM)	VDD	2.7	3.3	3.6	V	
I/O logic voltage	VDDIO	N/A	N/A	N/A	V	=VDD
Input voltage 'H' level	VIH	0.7VDD	-	VDD	V	
Input voltage 'L' level	VIL	0	-	0.3VDD	V	
Power supply current	IVDD	-	90	-	mA	
TFT gate on voltage	GH	N/A	N/A	N/A	V	Built in LCM
TFT gate off voltage	VGL	N/A	N/A	N/A	V	
Analog power supply voltage	AVDD	N/A	N/A	N/A	V	
Differential input common mode voltage	Vcom	N/A	N/A	N/A	V	

4. BACKLIGHT CHARACTERISTICS

(at Ta=25°C,RH=60%)

Item	Symbol	Min.	Typ.	Max.	Unit	Note
LED forward voltage	VF	8.7	9.6	10.5	V	
LED forward current	IF	-	480	-	mA	
LED power consumption	PLED	-	4.608	-	W	Note1
Number of LED	-	-	24	-	PCS	
Connection mode	-	3 in series *8 in parallel			/	
LED life-time	-	20000	-	-	Hrs	Note2

Note1. Calculator Value for reference: $IF \cdot VF = PLED$

Note2. The LED Life-time define as the estimated time to 50% degradation of initial brightness at Ta=25°C and IF =480mA. The LED lifetime could be decreased if operating IF is larger than 480mA

5.EXTERNAL DIMENSIONS

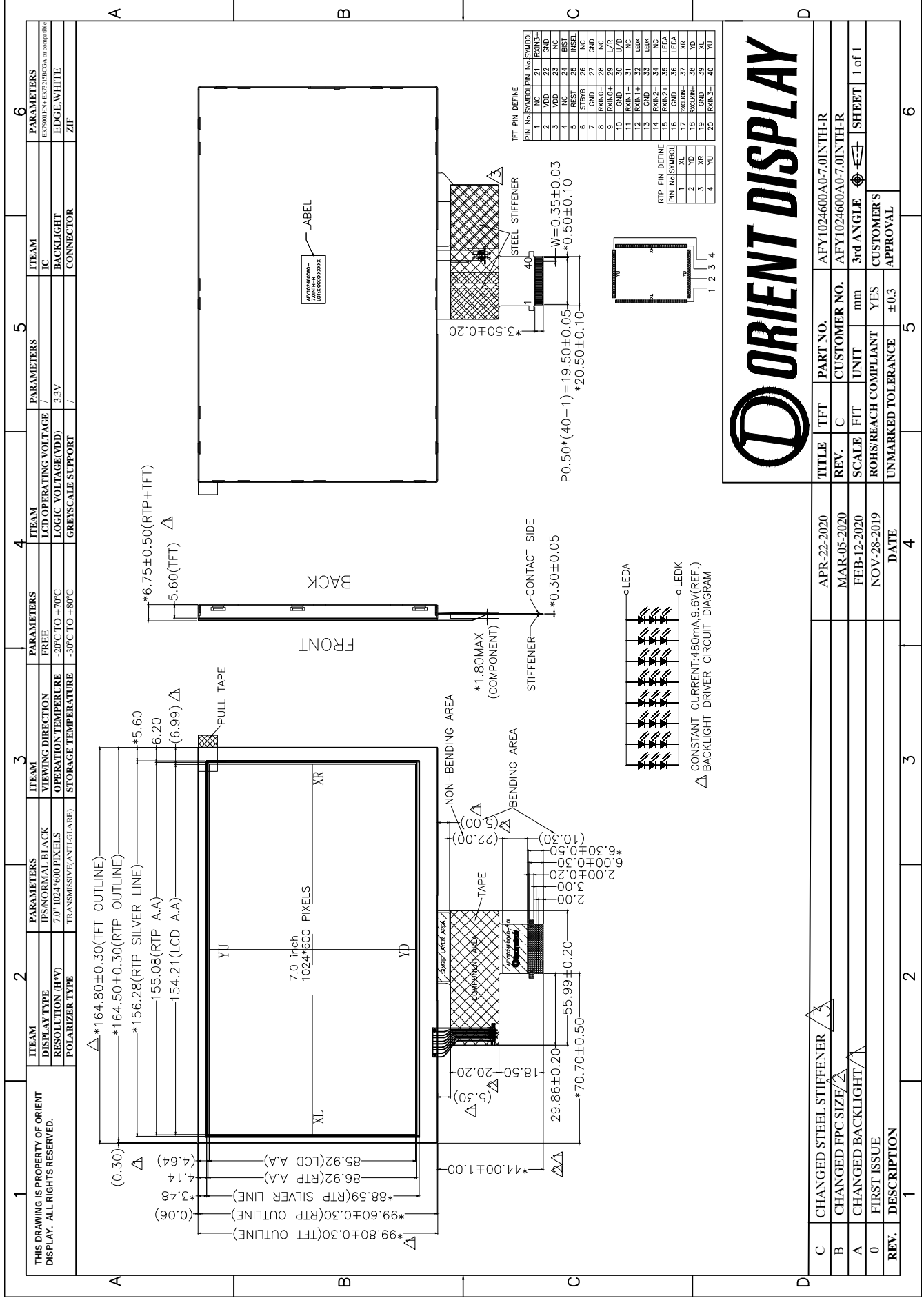

6. ELECTRO-OPTICAL CHARACTERISTICS

Item	Symbol	Condition	Min	Typ	Max	Unit	Remark	Note
Response time	Tr+ Tf	-	-	25	50	ms	FIG.1	Note 4
Contrast ratio	Cr		400	500	-	---	FIG.2	Note 1
Surface Luminance	Lv	$\theta=0^\circ$	650	800	-	cd/m2	FIG.2	Note 2
Luminance uniformity	-	$\theta=0^\circ$	75	80	-	%	FIG.2	Note 3
NTSC	-	$\theta=0^\circ$	-	50	-	%	FIG.2	Note 5
Viewing angle range	θ	$\varnothing = 90^\circ$	70	80	-	deg	FIG.3	Note 6
		$\varnothing = 270^\circ$	70	80	-	deg	FIG.3	
		$\varnothing = 0^\circ$	70	80	-	deg	FIG.3	
		$\varnothing = 180^\circ$	70	80	-	deg	FIG.3	
CIE (x, y) chromaticity	Red x	$\theta=0^\circ$ $\varnothing=0^\circ$ $T_a=25^\circ\text{C}$	Typ -0.04	TBD	Typ +0.04	-	FIG.2 CIE1931	Note 5
	Red y			TBD		-		
	Green x			TBD		-		
	Green y			TBD		-		
	Blue x			TBD		-		
	Blue y			TBD		-		
	White x			TBD		-		
	White y			TBD		-		

Note1. Definition of contrast ratio

Contrast Ratio(CR) is defined mathematically by the following formula. For more information see FIG.2

Average Surface Luminance with all white pixels (P1, P2, P3, P4, P5,P6,P7,P8,P9)

Contrast Ratio = $\frac{\text{Average Surface Luminance with all white pixels (P1, P2, P3, P4, P5,P6,P7,P8,P9)}}{\text{Average Surface Luminance with all black pixels (P1, P2, P3, P4, P5,P6,P7,P8,P9)}}$

Note2. Definition of surface luminance

Surface luminance is the LCD surface from the surface with all pixels displaying white. For more information see FIG.2

Lv = Average Surface Luminance with all white pixels(P1, P2, P3, P4, P5,P6,P7,P8,P9)

Note3. Definition of luminance uniformity

The luminance uniformity in surface luminance (δ WHITE) is determined by measuring luminance at each test position 1 through 9, and then dividing the maximum luminance of 9 points luminance by minimum luminance of 9 points luminance. For more information see FIG.2

Minimum Surface Luminance with all white pixels (P1, P2, P3, P4, P5,P6,P7,P8,P9)

Maximum Surface Luminance with all white pixels (P1, P2, P3, P4, P5,P6,P7,P8,P9)

Note4. Definition of Response time

The response time is defined as the LCD optical switching time interval between "White" state and "Black" state. Rise time (T_{ON}) is the time between photo detector output intensity changed from 90% to 10%.

And fall time (T_{OFF}) is the time between photo detector output intensity changed from 10% to 90%. For additional information see FIG1.

Note5. Definition of color chromaticity (CIE1931)

CIE (x, y) chromaticity, The x,y value is determined by screen active area center position P5, For more information see FIG.2

Note6. Definition of Viewing angle

Viewing angle is the angle at which the contrast ratio is greater than 10. angles are determined for the horizontal or x axis and the vertical or y axis with respect to the z axis which is normal to the LCD surface. For more information see FIG.3

For Viewing angle and response time testing, the testing data is base on Autronic-Melchers’s ConoScope or DMS series Instruments or compatible. For contrast ratio, Surface Luminance, Luminance uniformity and CIE,the testing data is base on TOPCON’s BM-5or BM-7 photo detector or compatible.

Note: For TFT module, Gray scale reverse occurs in the direction of panel viewing angle.**The definition of Response Time**

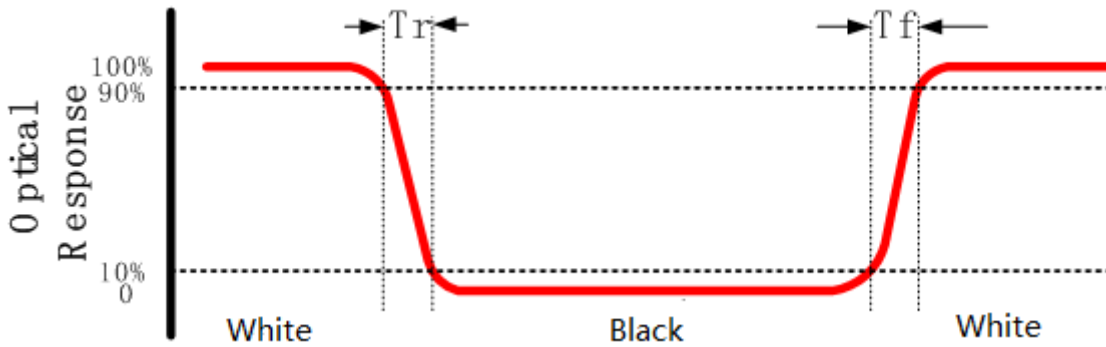

FIG.1. Measuring method for Contrast ratio, surface luminance, Luminance uniformity, CIE (x, y) chromaticity

Size: $S \leq 5''$ (see Figure a)

A : 5 mm B : 5 mm

H,V : Active Area

Light spot size $\varnothing = 5\text{mm}$ (BM-5) or $\varnothing = 7.7$

(BM-7)50cm distance or

compatible distance from the LCD surface to detector lens.

test spot position: see Figure a.

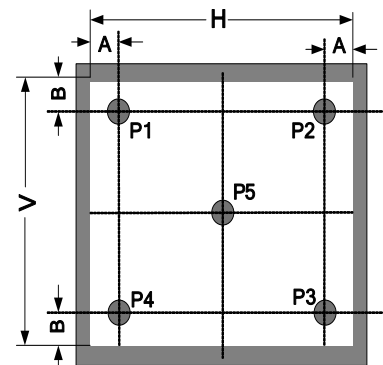

Figure a

measurement instrument : TOPCON’s luminance meter BM-5 or BM-7 or compatible (see Figure c)

Size: $5'' < S \leq 12.3''$ (see Figure b)

H, V : Active Area

Light spot size $\varnothing = 5\text{mm}$ (BM-5) or $\varnothing = 7.7\text{mm}$ (BM-7) 50cm distance or compatible distance from the LCD surface to detector lens

test spot position: see Figure b

measurement instrument : TOPCON's luminance meter BM-5 or BM-7 or compatible (see Figure c)

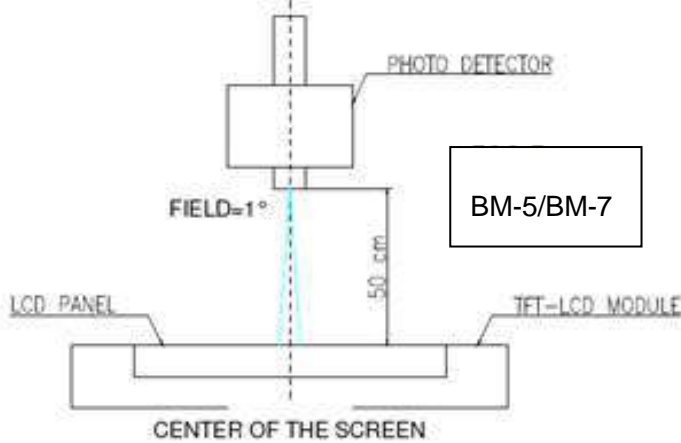
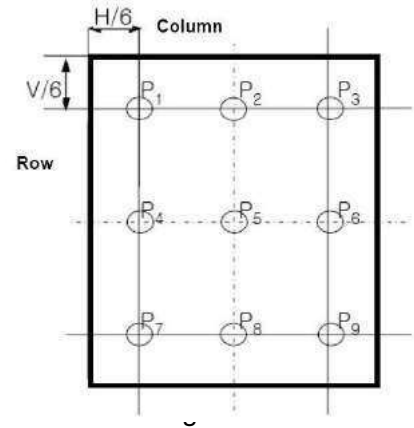
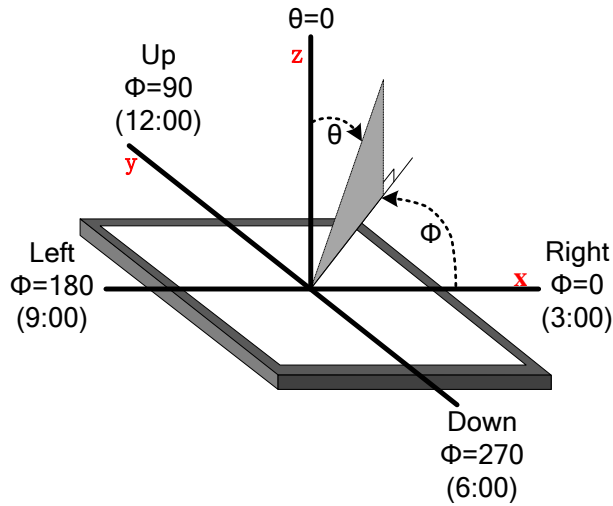

Figure c

FIG.2. The definition of viewing angle



7. LCM INTERFACE DESCRIPTION

Interface NO.	PIN NAME	I/O	DESCRIPTION
1	N/C	Float	No connection,Please float it
2-3	VDD	P	Power supply for digital
4	NC	I	Dither="L" , to enable internal dithering function; DITHB="H" , to disable internal dithering function;
5	REST	I	Global reset pin. Active Low. Normally pull high.
6	STBYB	I	Display on/off switch,"H" display off
7	GND	P	Ground
8	RXIN0-	I/O	LVDS data lane 0-
9	RXIN0+	I/O	LVDS data lane 0+
10	GND	P	Ground
11	RXIN1-	I/O	LVDS data lane 1-
12	RXIN1+	I/O	LVDS data lane 1+
13	GND	P	Ground
14	RXIN2-	I/O	LVDS data lane 2-
15	RXIN2+	I/O	LVDS data lane 2+
16	GND	P	Ground
17	RXCLKIN-	I/O	LVDS clk lane -
18	RXCLKIN+	I/O	LVDS clk lane +
19	GND	P	Ground
20	RXIN3-	I/O	LVDS data lane 3-
21	RXIN3+	I/O	LVDS data lane 3+
22	GND	P	Ground
23	NC	Float	No connection,Please float it
24	BIST	I	SELB="L" for 8-bit LVDS;
25	INSEL	Float	SELB="L" for TTL Interface;
26	NC	Float	No connection,Please float it
27	GND	P	Ground
28	NC	Float	No connection,Please float it
29	L/R	I	L/R="L" Scan direction from right to left;
30	U/D	I	U/D="L" Scan direction from down to up;
31	NC	Float	No connection,Please float it
32-33	LEDK	P	LED Cathode for BL
34	NC	Float	No connection,Please float it
35-36	LEDA	P	LED ANODE for BL
37	XR(NC)	I	X-Right
38	YD(NC)	I	Y-Up
39	XL(NC)	I	X-Left
40	YU(NC)	I	Y-Bottom

8.Lvds CHARACTERISTICS

8.1 Absolute maximum rating (GND=AGND=0V)

Parameter	Symbol	Spec.			Unit
		Min.	Typ.	Max.	
Power supply voltage 1	VDD	-0.5	-	+3.96	V
Power supply voltage 2	AVDD	-0.5	-	+14.85	V
Logic Output Voltage	V _{OUT}	-0.5	-	+5.0	V
Input voltage	V _{IN}	-0.5	-	AVDD+0.5	V
Operation temperature	T _{OPR}	-20	-	+85	°C
Storage temperature	T _{STG}	-55	-	+125	°C

Note: (1) All of the voltages listed above are with respect to GND=0V.

(2) Device is subject to be damaged permanently if stresses beyond those absolute maximum ratings listed above.

Table 8.1 Absolute maximum rating

8.2 Lvds mode DC electrical characteristics

LVDS DC characteristic

Parameter	Symbol	Min.	Typ.	Max.	Unit	Condition
Differential input high threshold voltage	RxVTH			+0.1V	V	RxVCM=1.2V
Differential input low threshold voltage	RxVTL	-0.1			V	
Input voltage range(single-end)	RxVIN	0		2.4	V	
Differential input common mode voltage	RxVCM	V _{IO}]/2		2.4 - V _{IO}]/2	V	
Differential input voltage	V _{IO}	0.2		0.6	V	
Differential input leakage current	RxVTH	-10		+10	μA	
LVDS Digital Operating Current	I _{ddlvds}	-	40(TBD)	50	mA	Fclk=65Mhz, VDD=3.3V
LVDS Digital Standby Current	I _{stlvds}	-	10(TBD)	50	μA	Clock & all functions are stop

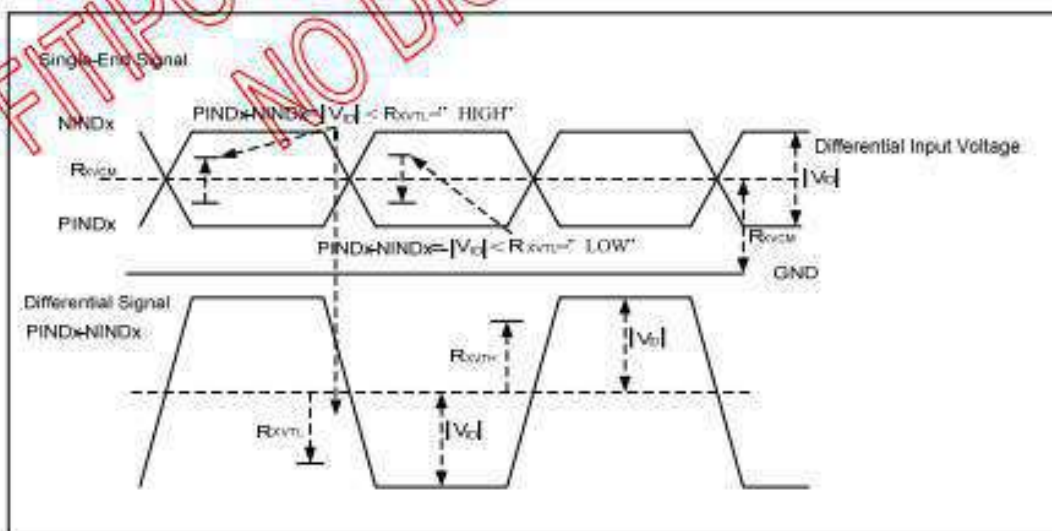

Table 8.2 Lvs mode DC electrical characteristics

8.3 PWM power table

Parameter	Symbol	Min.	Typ.	Max.	Unit	Condition
Base drive current for PWM	IDRV	-	-	60	mA	DRVA = 0.7V
DRV output voltage for PWM	VDRV	0	-	VDD	V	
Feedback voltage for PWM	VFB	1.1	1.2	1.3	V	
Duty cycle maximum	Dmax	-	-	85	%	
VCOM buffer input voltage	VCOMI	1	-	AVDD	V	
VCOM buffer output voltage	VCOMO	VCOMI-0.2	VCOMI	VCOMI+0.2	V	
VCOM buffer output current	IVCOM	-	-	10	mA	VCOMO= 5V vs 4.9V

Table 8.3 Power table

8.4 Lvs mode AC electrical characteristics

Parameter	Symbol	Condition	Min.	Typ.	Max.	Unit
Clock Frequency	RxFCLK		20	-	71	MHz
Input data skew margin	TRSKM	VID =400mV RsvVCM=1.2V RxFCLK=71MHz	500			ps
Clock High Time	TLVCH			4/(7* RxFCLK)		ns
Clock Low Time	TLVCL			3/(7* RxFCLK)		ns
PLL wake-up-time	TenPLL				150	us

Table 8.4 Lvs mode AC electrical characteristics

8.5 Lvs Figure

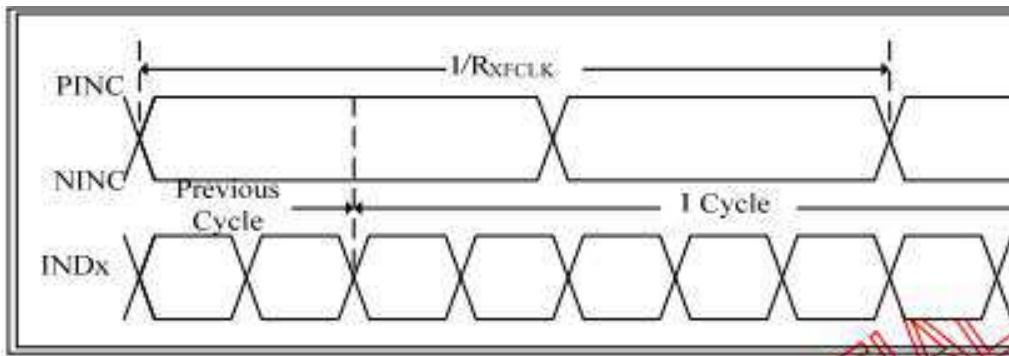

LVDS firing(1)

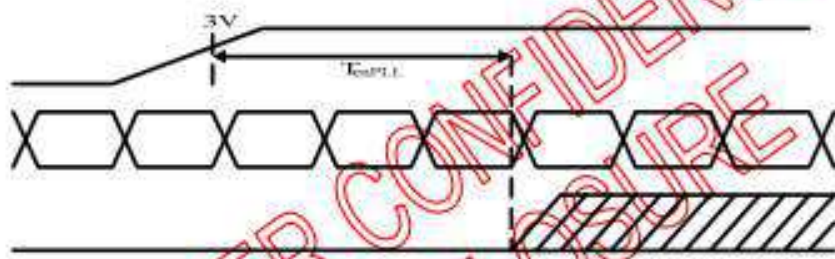

LVDS firing(2)

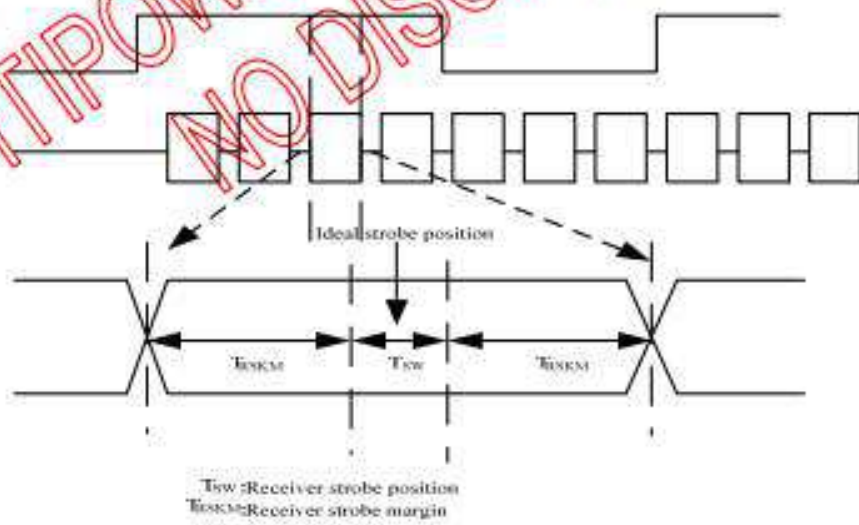

Table 8.5 Lvds Figure

8.6 Lvds mode data input format

8.6.1 6 bit Lvds input

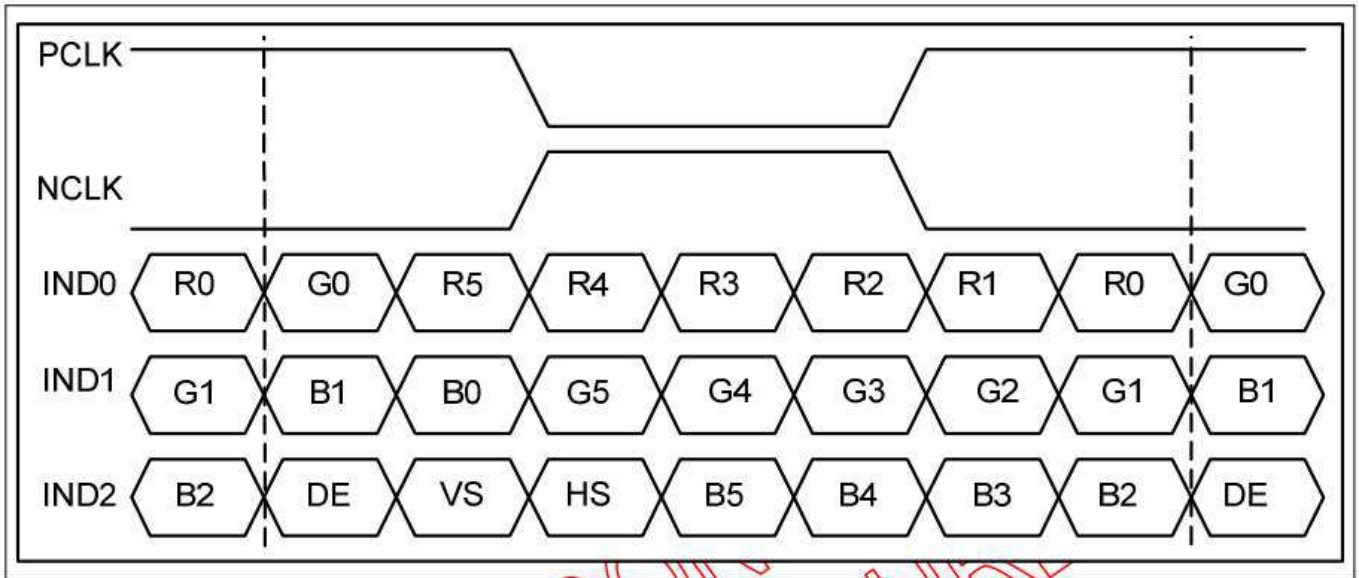

Figure 8.1 6 bit Lvds input

8.6.2 8 bit Lvds input

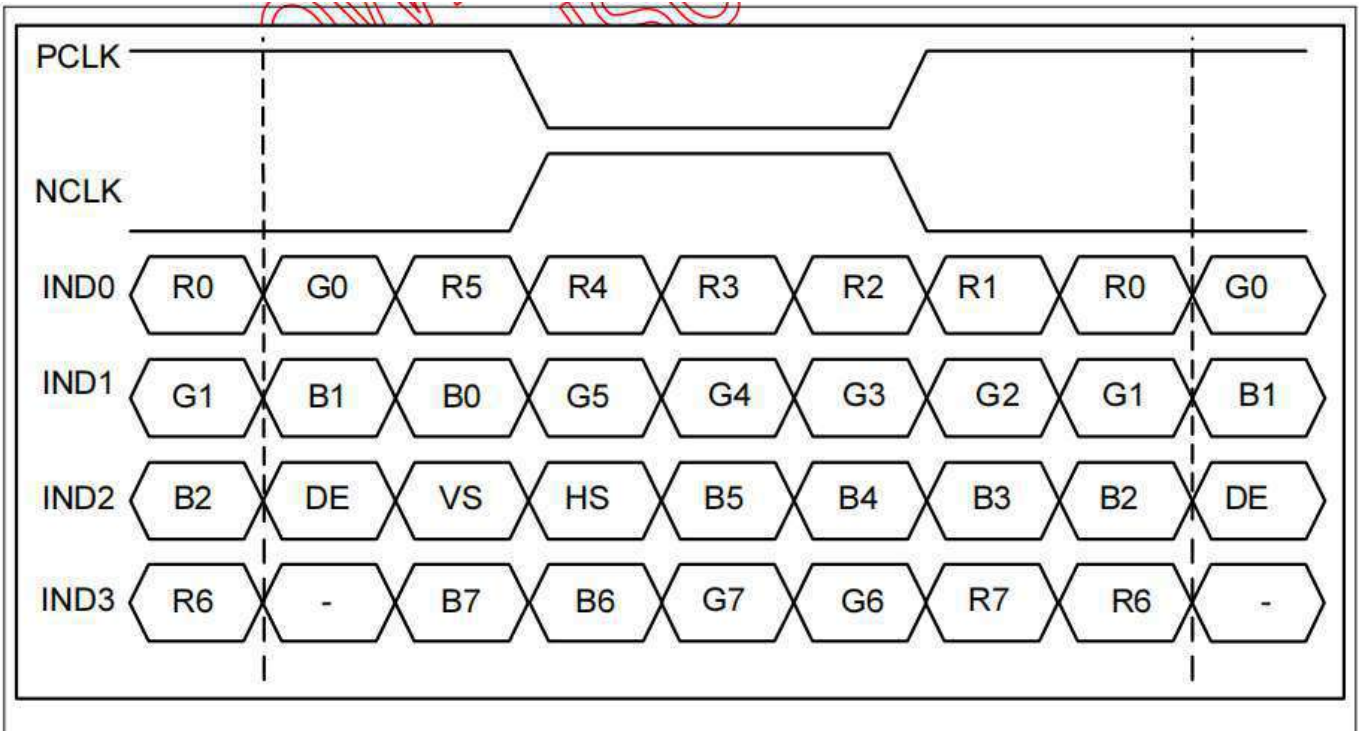
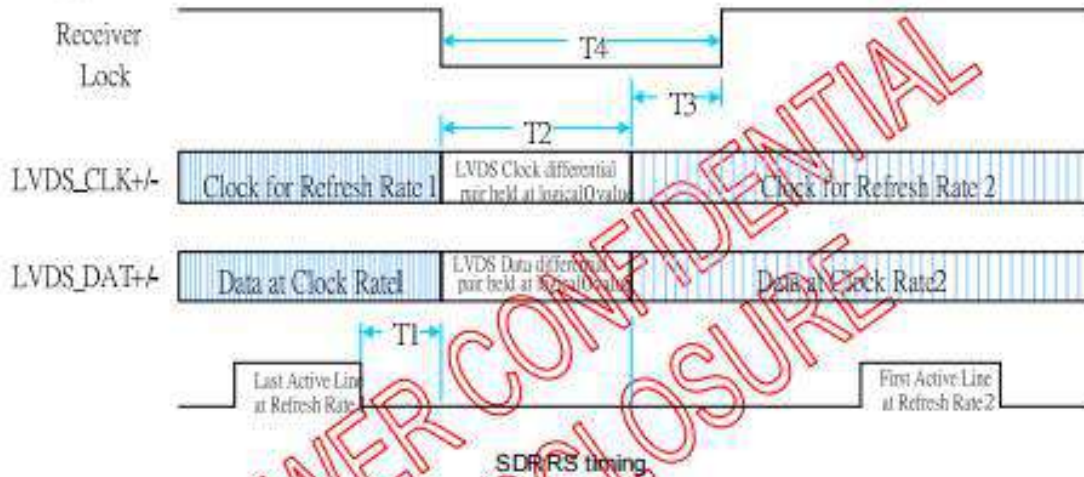

Figure 8.2 8 bit Lvds data input

8.7 SDRRS TIMING DIAGRAM

SDRRS(seamless display refresh rate switching)

When Showing the still picture, it is accept to refresh rate from 60Hz to low refresh rate (for example 40Hz). The purpose is mainly for power saving. INTEL defined a timing chart switch between different refresh rate. Following this timing chart, the switch between different refresh rates is seamless for end user.



SDRRS timing

T1-Min delay from start of vertical blank to start of timing change:2 lines(HSYNC periods)

T2-Max delay for clock to transition to new frequency: 100us

T3-Max receiver lock delay from stable clock: Display specific

T4-Max period during which panel maintains display(T_2+T_3): Display specific

9. POWER SEQUENCE

9.1. Power On/Off Sequence

In order to prevent IC from power on reset fail, the rising time (TPOR) of the digital power supply VDD should be maintained within the given specifications. Refer to "AC Characteristics" for more detail on timing.

9.2. Power-On/Off Timing Sequence

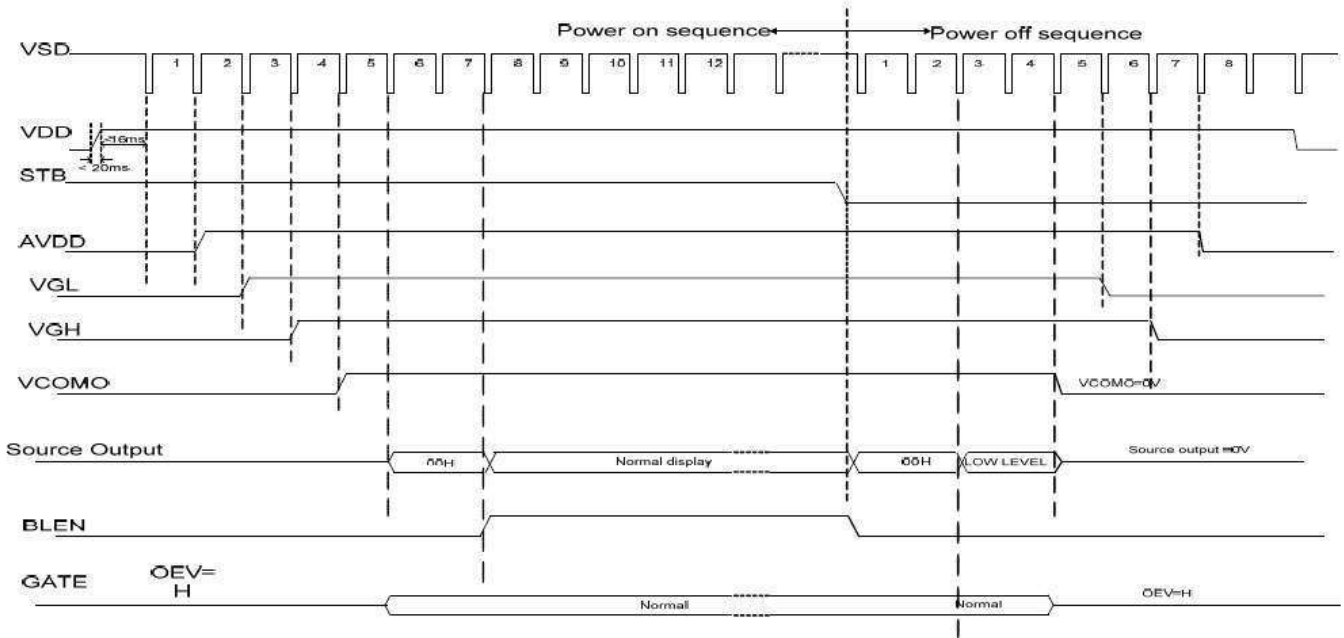

Power On/Off timing chart

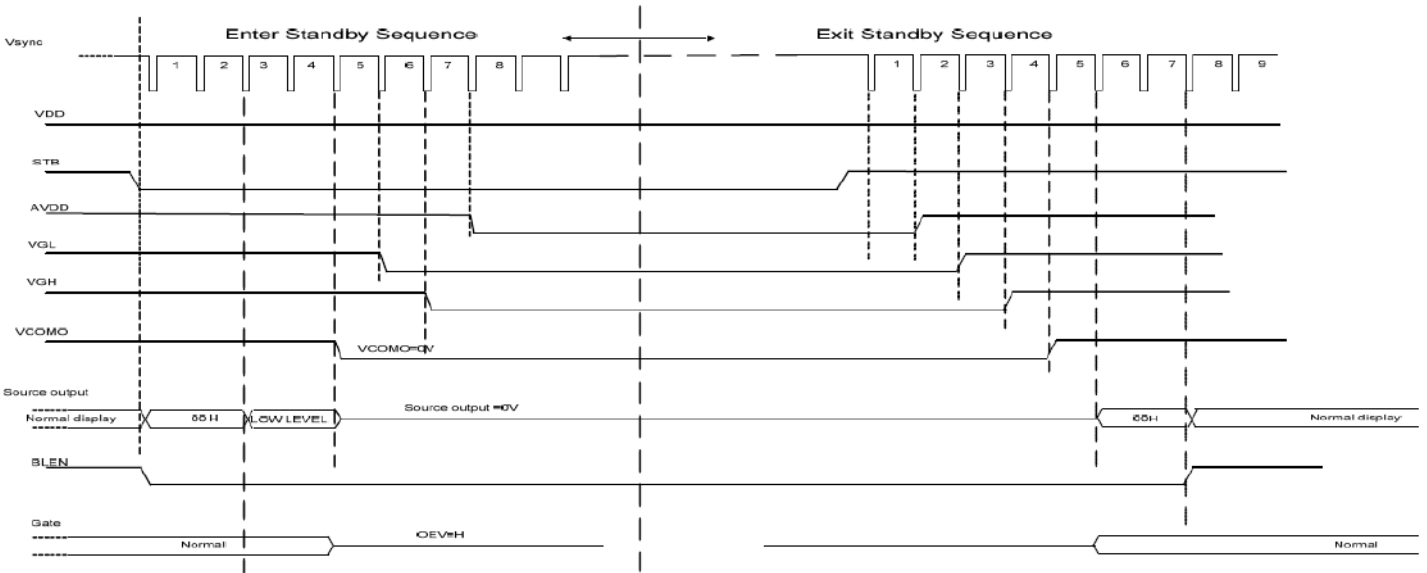

Enter and Exit Standby Mode timing chart

10. RELIABILITY TEST CONDITIONS

No.	Test Item	Test Condition	Inspection after test
1	High Temperature Storage	+80C/240 hours	Inspection after 2~4hours storage at room temperature, the sample shall be free from defects: 1.Current changing value before test and after test is 50% larger; 2. function defect:Non-display ,abn ormal-display,missing lines,Short lines, ITO corossion; 3.visual defect:Air bubble in the LCD,Sealleak,Glass crack。
2	Low Temperature Storage	-30°C/240 hours	
3	High Temperature Operating	+70°C/120 hours	
4	Low Temperature Operating	-20°C/120 hours	
5	Temperature Cycle	-30°C ~ 25°C ~ +80°C/10cycles (30min.) (10min.) (30min.)	
6	Damp Proof Test	50°C*90% RH/120 hours	
7	Vibration Test	Frequency: 10Hz~55Hz~10Hz Amplitude: 1.5mm, X, Y, Z direction for total 3hours (Packing condition)	
8	Dropping test	Drop to the ground from 1m height, one time, every side of carton. (Packing condition)	
9	ESD test	Voltage:±8KV R: 330Ω C: 150pF Air discharge, 10times	

Remark:

- 1.The test samples should be applied to only one test item.
- 2.Sample size for each test item is 3~5pcs.
- 3.For Damp Proof Test, Pure water(Resistance> 10MΩ) should be used.
- 4.In case of malfunction defect caused by ESD damage, if it would be recovered to normal state after resetting, it would be judged as a good part.
- 5.EL evaluation should be excepted from reliability test with humidity and temperature: Some defects such as black spot/blemish can happen by natural chemical reaction with humidity and Fluorescence EL has.
- 6.Failure Judgment Criterion: Basic Specification, Electrical Characteristic, Mechanical Characteristic, Optical Characteristic.
- 7.The finished surface should be free of Drips,Globs,Glue and contamination.
- 8.The paint must adhere to the cover lens and withstand the following test:
Pressure sensitive tape(SCOTCH #610 or equivalent adhesion strength) is applied to the painted surface
And then rapidly removed by pulling at a 90 degree angle to the surface; There should be no evidence of paint seriating from the glass.

11. INSPECTION CRITERION

Refer to 《Inspection Criterion for TFT》 V2.3

12. HANDLING PRECAUTIONS

12.1 Mounting method

The LCD module consists of two thin glass plates with polarizers which easily be damaged. And since the module is so constructed as to be fixed by utilizing fitting holes in the printed circuit board. Extreme care should be needed when handling the LCD modules.

12.2 Caution of LCD handling and cleaning

When cleaning the display surface, Use soft cloth with solvent [recommended below] and wipe lightly

- .Isopropyl alcohol
- .Ethyl alcohol

Do not wipe the display surface with dry or hard materials that will damage the polarizer surface.

Do not use the following solvent:

- .Water
- .Aromatics

Do not wipe ITO pad area with the dry or hard materials that will damage the ITO patterns

Do not use the following solvent on the pad or prevent it from being contaminated:

- .Soldering flux
- .Chlorine (Cl) , Sulfur (S)

If goods were sent without being silicon coated on the pad, ITO patterns could be damaged due to the corrosion as time goes on.

If ITO corrosion happens by miss-handling or using some materials such as Chlorine (Cl), Sulfur (S) from customer, Responsibility is on customer.

12.3 Caution against static charge

The LCD module uses C-MOS LSI drivers, so we recommend that you:

Connect any unused input terminal to V_{dd} or V_{ss}, do not input any signals before power is turned on, and ground your body, work/assembly areas, assembly equipment to protect against static electricity.

12.4 Packing

Module employs LCD elements and must be treated as such.

- .Avoid intense shock and falls from a height.
- .To prevent modules from degradation, do not operate or store them exposed direct to sunshine or high temperature/humidity

12.5 Caution for operation

●.It is an indispensable condition to drive LCD's within the specified voltage limit since the higher voltage than the limit causes the shorter LCD life.

●.An electrochemical reaction due to direct current causes LCD's undesirable deterioration, so that the use of direct current drive should be avoided.

●.Response time will be extremely delayed at lower temperature than the operating temperature range and on the other hand at higher temperature LCD's show dark color in them. However those phenomena do not mean malfunction or out of order with LCD's, which will come back in the specified operation temperature.

●.If the display area is pushed hard during operation, some font will be abnormally displayed but it resumes normal condition after turning off once.

●.A slight dew depositing on terminals is a cause for electro-chemical reaction resulting in terminal open circuit.

Usage under the maximum operating temperature, 50%Rh or less is required.

12.6 Storage

In the case of storing for a long period of time for instance, for years for the purpose or replacement use, the following ways are recommended.

- .Storing in an ambient temperature 10°C to 30°C, and in a relative humidity of 45% to 75%. Don't expose to

sunlight or fluorescent light.

- .Storing in a polyethylene bag with the opening sealed so as not to enter fresh air outside in it . And with no desiccant.
- .Placing in a dark place where neither exposure to direct sunlight nor light's keeping the storage temperature range.
- .Storing with no touch on polarizer surface by the anything else.

It is recommended to store them as they have been contained in the inner container at the time of delivery from us.

12.7 Safety

- .It is recommendable to crash damaged or unnecessary LCD's into pieces and wash off liquid crystal by either of solvents such as acetone and ethanol, which should be burned up later.
- .When any liquid leaked out of a damaged glass cell comes in contact with your hands, please wash it off well with soap and water

13. PRECAUTION FOR USE

14.1 A limit sample should be provided by the both parties on an occasion when the both parties agreed its necessity. Judgment by a limit sample shall take effect after the limit sample has been established and confirmed by the both parties.

13.2 On the following occasions, the handing of problem should be decided through discussion and agreement between responsible of the both parties.

- .When a question is arisen in this specification
- .When a new problem is arisen which is not specified in this specifications
- .When an inspection specifications change or operating condition change in customer is reported to ODNA , and some problem is arisen in this specification due to the change
- .When a new problem is arisen at the customer's operating set for sample evaluation in the customer site.

14. PACKING SPECIFICATION

Please consult our technical department for detail information.