



**SPECIFICATION  
FOR  
LCD MODULE**

**MODULE NO: AFK800480A0-7.0N12NTM-R  
REVISION NO: V01**

Customer's Approval:

--

	SIGNATURE	DATE
PREPARED BY (RD ENGINEER)		
CHECKED BY		
APPROVED BY		

## Records of Revision

DATE	REF.PAGE PARAGRAPH DRAWING No.	REVISED No.	SUMMARY	REMARK
2015-11-25		V01	First Issue	

# Contents

1. General Specification.....	4
2. Mechanical Drawing.....	5
3. Block Diagram.....	6
4. Interface Pin Function.....	7
5. Absolute Maximum Ratings.....	9
6. Electrical Characteristics.....	10
7. Optical Characteristics.....	12
8. Timing Characteristics.....	15
9. Standard Specification for Reliability.....	18
10. General Precautions.....	19
11. Packing Method.....	19

# 1. General Specification

<b>Item</b>	<b>Contents</b>	<b>Unit</b>
LCD TYPE	TFT/TRANSMISSIVE	
MODULE SIZE (W*H*T)	164.80*99.80*7.1	MM
ACTIVE SIZE (W*H)	154.08*85.92	MM
PIXEL PITCH (W*H)	0.1926*0.1790	MM
NUMBER OF DOTS	800*480	
DIVER IC	HX8264+HX8664	
INTERFACE TYPE	24-BIT RGB	
TOP POLARIZER TYPE	ANTI-GLARE	
RECOMMEND VIEWING DIRECTION	12	O'CLOCK
GRAY SCALE INVERSION DIRECTION	6	O'CLOCK
COLORS	16.7M	
BACKLIGHT TYPE	21-LED WHITE	
TOUCH PANEL TYPE	RESISTIVE	

# 2. Mechanical Drawing

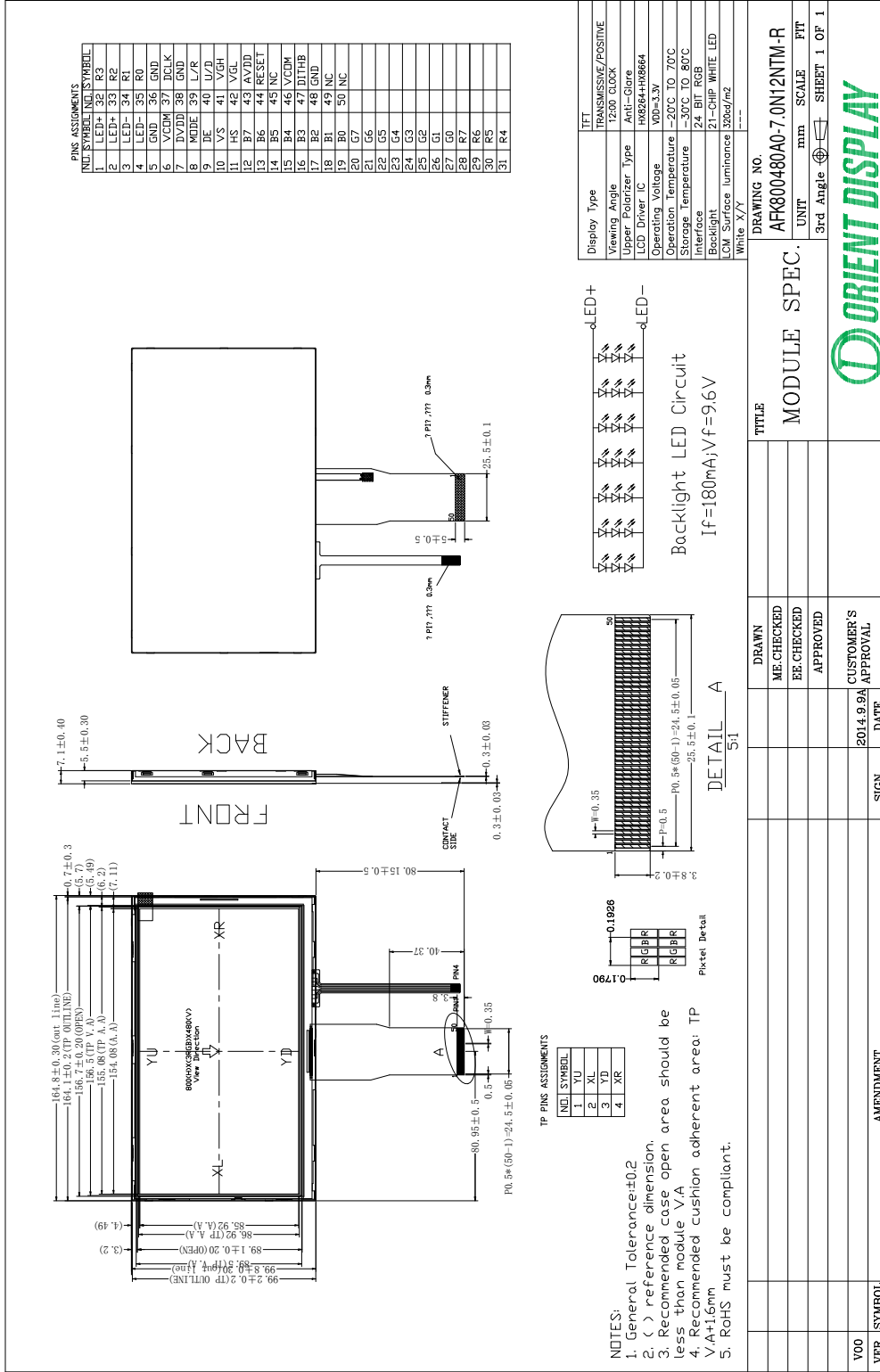

### 3. Block Diagram

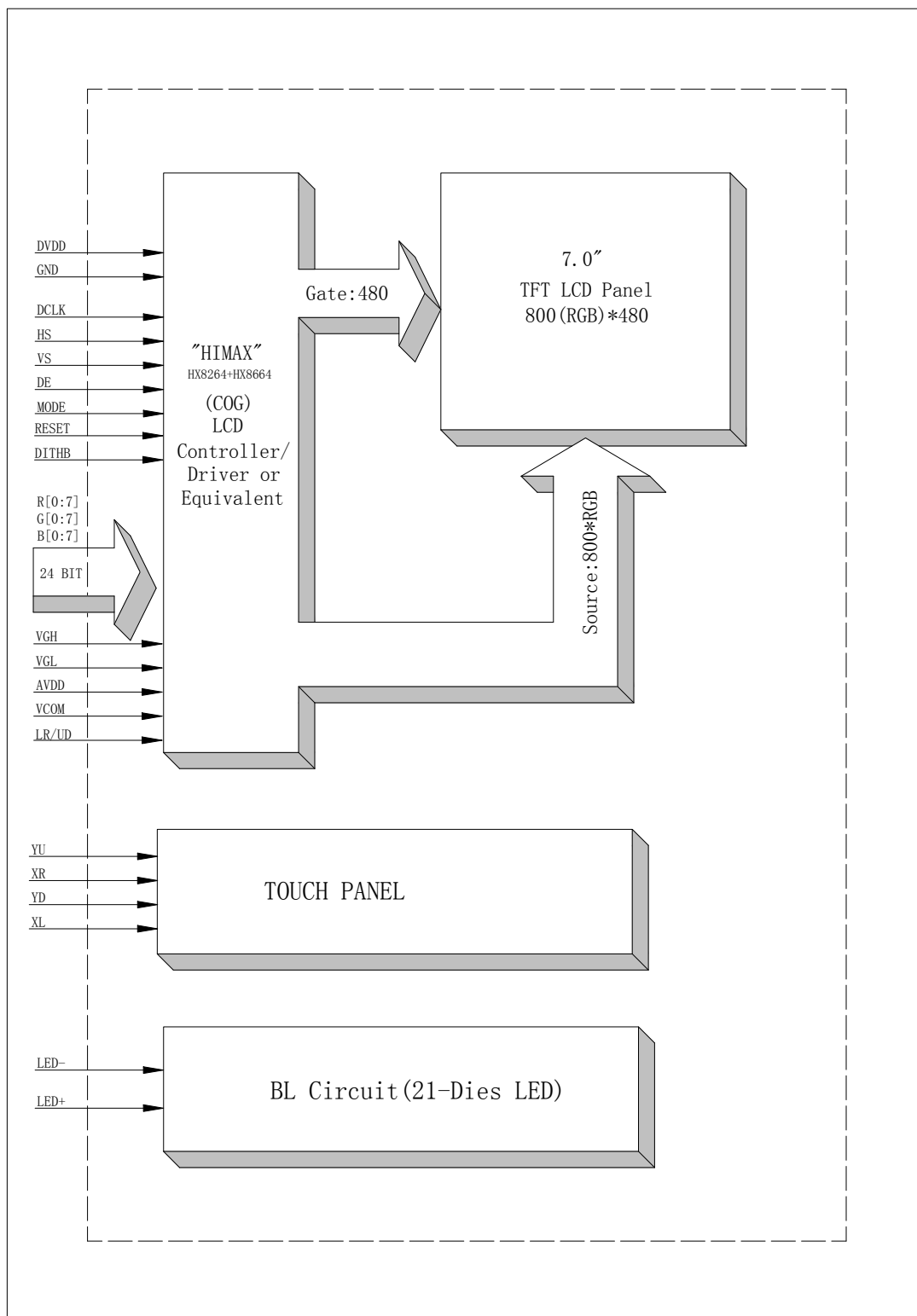

## 4. Interface Pin Function

Pin No.	Symbol	Description
1	LED+	Anode of LED backlight
2	LED+	Anode of LED backlight
3	LED-	Cathode of LED backlight
4	LED-	Cathode of LED backlight
5	GND	Power ground
6	VCOM	Common voltage
7	DVDD	Power for digital circuit
8	MODE	DE/SYNC mode select
9	DE	Data input enable
10	VS	Vertical sync input
11	HS	Horizontal sync input
12	B7	Blue data(MSB)
13	B6	Blue data
14	B5	Blue data
15	B4	Blue data
16	B3	Blue data
17	B2	Blue data
18	B1	Blue data
19	B0	Blue data(LSB)
20	G7	Blue data(LSB)
21	G6	Green data
22	G5	Green data
23	G4	Green data
24	G3	Green data
25	G2	Green data
26	G1	Green data
27	G0	Green data(LSB)
28	R7	Red data(MSB)
29	R6	Red data
30	R5	Red data
31	R4	Red data
32	R3	Red data
33	R2	Red data
34	R1	Red data
35	R0	Red data(LSB)
36	GND	Power Ground
37	DCLK	Sample clock
38	GND	Power Ground
39	L/R	Left / right selection
40	U/D	Up/down selection

41	VG	Gate ON Voltage
42	VG	Gate OFF Voltage
43	AVDD	Power for Analog Circuit
44	RESET	Global reset pin.
45	NC	No connection
46	VCOM	Common Voltage
47	DITHB	Dithering function
48	GND	Power Ground
49	NC	No connection
50	NC	No connection

**NOTE:**

Note1: DE/SYNC mode select. Normally pull high.

When select DE mode, MODE="1", VS and HS must pull high.

When select SYNC mode, MODE="0", DE must be grounded.

Note 2: When input 18 bits RGB data, the two low bits of R, G and B data must be grounded.

Note 3: Data shall be latched at the falling edge of DCLK.

Note 4: Selection of scanning mode.

Set of scan control input		Scanning direction
U/D	L/R	
GND	DVDD	Up to down, left to right
DVDD	GND	Down to up, right to left
GND	GND	Up to down, right to left
DVDD	DVDD	Down to up, left to right

Note 5: Definition of scanning direction.

Refer to the figure as below:

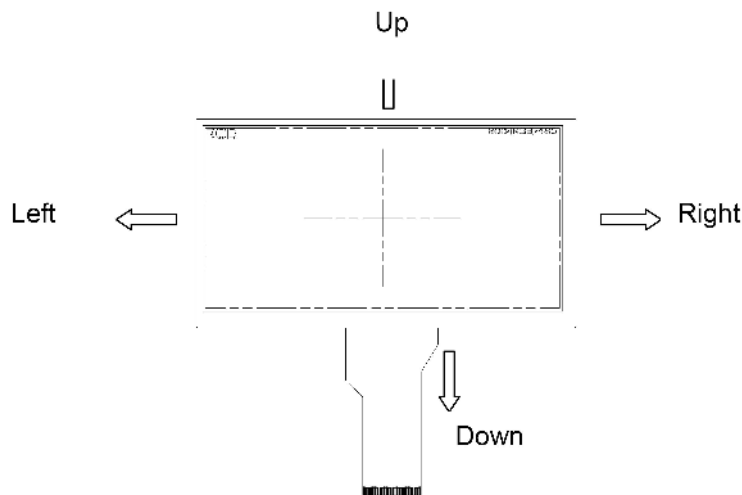

Note 6: Global reset pin. Active low to enter reset state. Suggest connecting with an RC Reset circuit for stability. Normally pull high.

Note 7: Dithering function enable control, normally pull high.

When DITHB="1", Disable internal dithering function,

When DITHB="0", Enable internal dithering function.



## 5. Absolute Maximum Ratings

Parameter	Symbol	Min	Max	Unit
Supply voltage for logic	DVDD	-0.3	5	V
Supply voltage for analog	AVDD	6.5	13.5	V
Power supply	VGH	-0.3	40	V
Power supply	VGL	-20	0.3	V
Power supply	VGH-VGL	-	40	V
Supply current (One LED)	I <sub>LED</sub>		30	mA
Operating temperature	T <sub>OP</sub>	-20	+70	°C
Storage temperature	T <sub>ST</sub>	-30	+80	°C

Note: The absolute maximum rating values of this product are not allowed to be exceeded at any times. Should a module be used with any of the absolute maximum ratings exceeded, the characteristics of the module may not be recovered, or in an extreme case, the module may be permanently destroyed.

## 6. Electrical Characteristics

### 6.1 Input Power

Item	Symbol	Min	Typ.	Max	Unit	Applicable terminal
Supply Voltage for Analog	DVDD	3.0	3.3	3.6	V	
Supply Voltage for Logic	AVDD	9.4	9.6	9.8	V	
Power supply	VGH	17.0	18.0	19.0		
Power supply	VGL	-6.6	-6.0	-5.4		
Power supply	VCOM	3.8	4.0	4.2		
Input Voltage	V <sub>IL</sub>	0	-	0.3DVDD	V	
	V <sub>IH</sub>	0.7 DVDD	-	DVDD		
Input leakage Current	I <sub>LKG</sub>	-		-	μA	

### 6.2 Backlight Driving Conditions

Item	Symbol	Value			Unit	Remark
		Min.	Typ.	Max.		
Voltage for LED Backlight	V <sub>F</sub>	-	9.6	10.8	V	I <sub>L</sub> =180mA
Current for LED Backlight	I <sub>L</sub>		180		mA	
Power Consumption	P		1.728		W	
LED Life Time		30,000			Hr	Note

Note: Brightness to be decreased to 50% of the initial value at ambient temperature TA=25°C

## 7. Optical Characteristics

ITEM	SYMBOL	CONDITIONS	SPECIFICATIONS			UNIT	NOTE
			MIN	TYP.	MAX		
Luminance	L	$I_L = 180\text{mA}$	-	320	-	$\text{Cd/m}^2$	
Contrast Ratio	CR	$\theta = 0^\circ$	300	400			
Response Time	$T_{\text{ON}}$	$25^\circ\text{C}$		25	35	ms	
	$T_{\text{OFF}}$						
CIE Color Coordinate	Red	$X_R$	Viewing normal angle				
		$Y_R$					
	Green	$X_G$					
		$Y_G$					
	Blue	$X_B$					
		$Y_B$					
	White	$X_W$			0.300		
		$Y_W$			0.340		
Viewing Angle	Hor.	$\theta_{X+}$	$\text{CR} \geq 10$	60	70	Degree	
		$\theta_{X-}$		60	70		
	Ver.	$\theta_{Y+}$		40	50		
		$\theta_{Y-}$		60	70		
Uniformity	Un			70	75	%	

**Note 1: Definition of Viewing Angle  $\theta_x$  and  $\theta_y$ :**

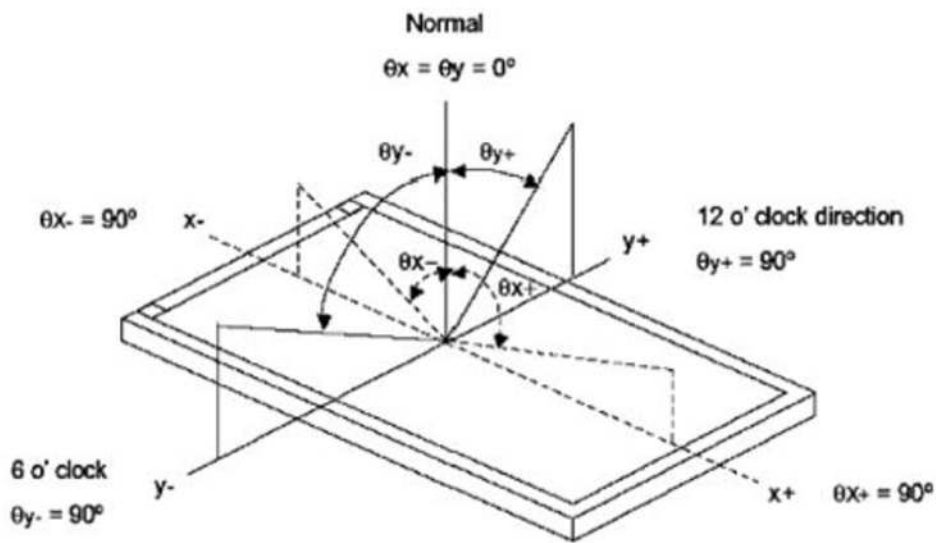

**Note 2: Definition of contrast ratio CR:**

$$CR = \frac{\text{Luminance of white state}}{\text{Luminance of black state}}$$

**Note 3: Definition of Response Time ( $T_r, T_f$ )**

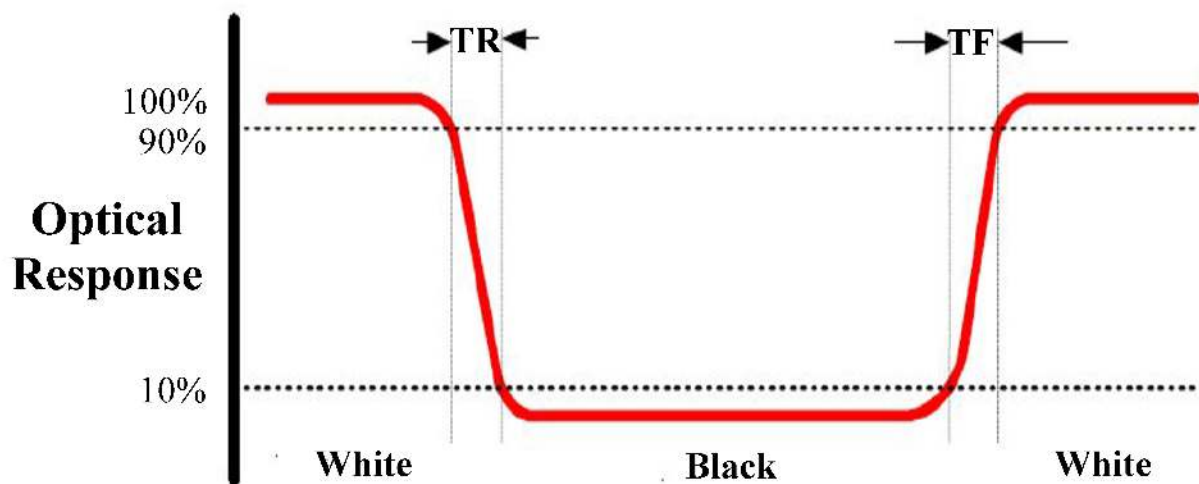

## Note 4: Definition of Luminance

### ①The Brightness Test Equipment Setup

Field=2° (As measuring “black” image, field=2° is the best testing condition)

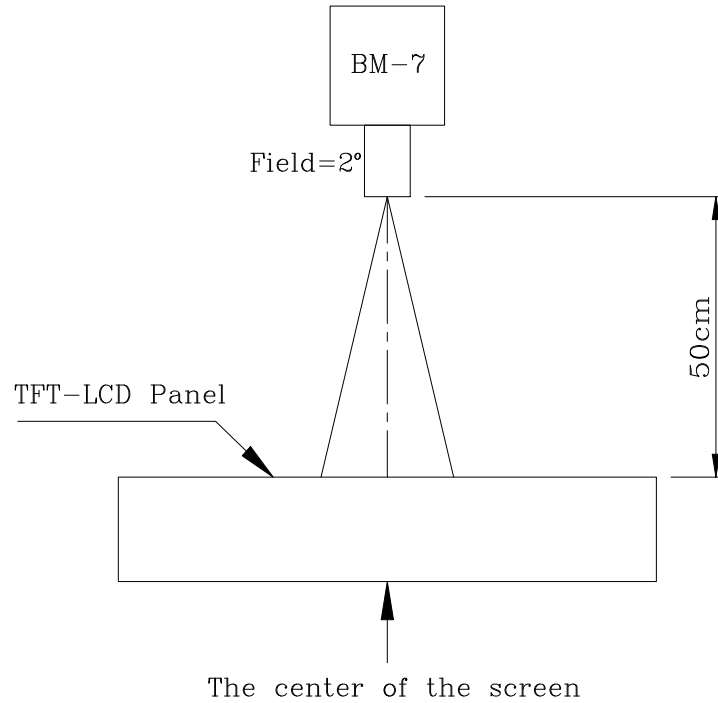

### ②The Brightness Test Point Setup

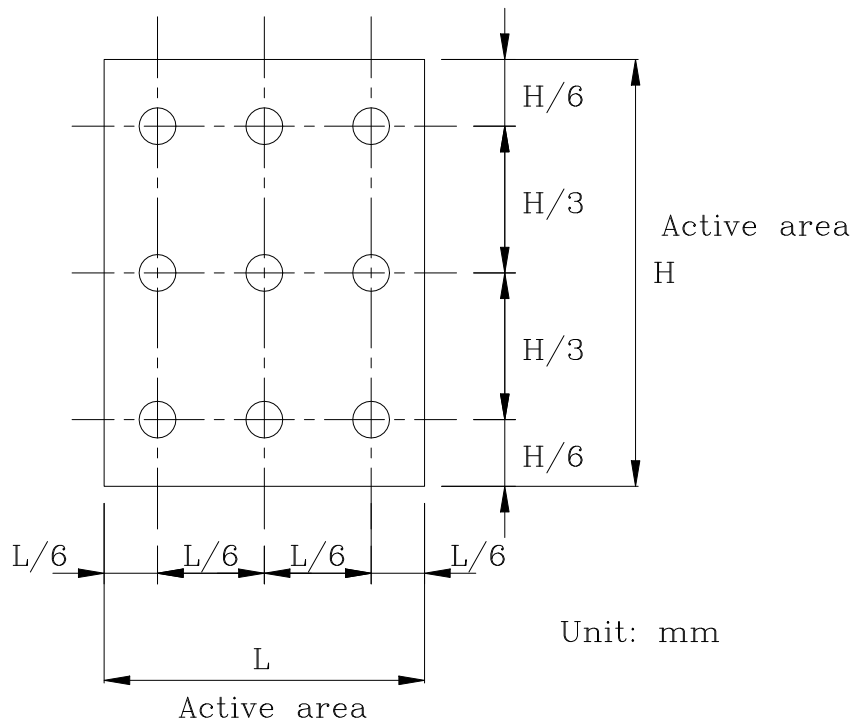

# 8. Timing Characteristics

## 8.1 Power Sequence

### Power on

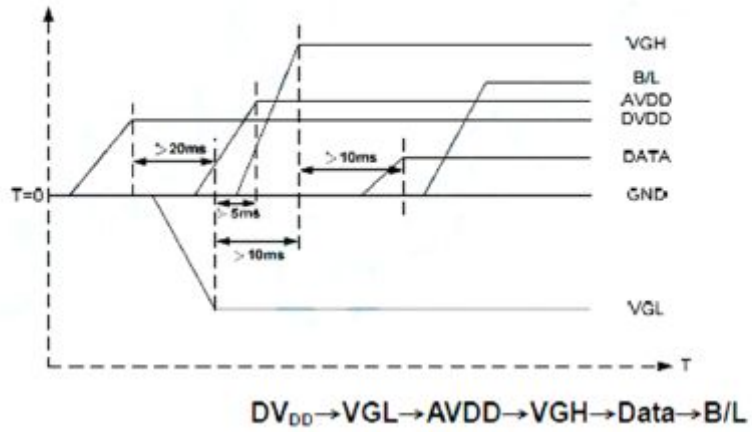

### Power off

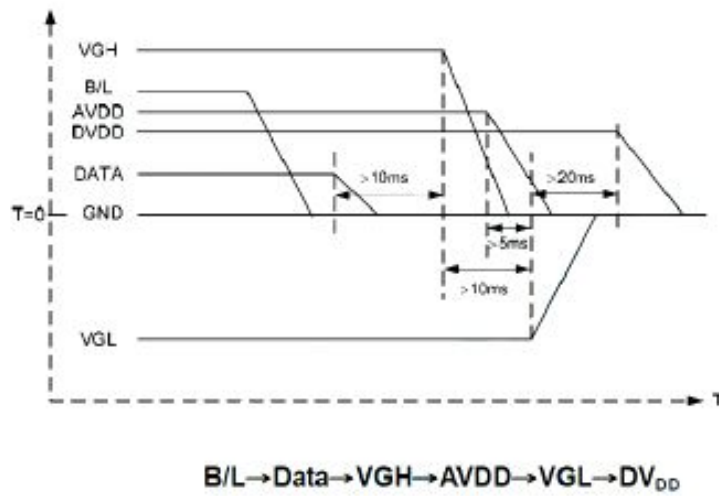

## 8.2 AC electrical characteristics

Item	Symbol	Values			Unit	Remark
		Min.	Typ.	Max.		
HS setup time	T <sub>hst</sub>	8	-	-	ns	
HS hold time	T <sub>hh</sub> <sub>d</sub>	8	-	-	ns	
VS setup time	T <sub>vst</sub>	8	-	-	ns	
VS hold time	T <sub>vh</sub> <sub>d</sub>	8	-	-	ns	
Data setup time	T <sub>ds</sub> <sub>u</sub>	8	-	-	ns	
Data hole time	T <sub>dh</sub> <sub>d</sub>	8	-	-	ns	
DE setup time	T <sub>es</sub> <sub>u</sub>	8	-	-	ns	
DE hole time	T <sub>eh</sub> <sub>d</sub>	8	-	-	ns	
DVDD Power On Slew rate	TPOR	-	-	20	ms	From 0 to 90% DVDD
RESET pulse width	T <sub>Rst</sub>	1	-	-	ms	
DCLK cycle time	T <sub>co</sub> <sub>h</sub>	20	-	-	ns	
DCLK pulse duty	T <sub>cwh</sub>	40	50	60	%	

## 8.3 RGB Timing Table

Item	Symbol	Values			Unit	Remark
		Min.	Typ.	Max.		
Horizontal Display Area	thd	-	800	-	DCLK	
DCLK Frequency	felk	29.0	33.0	38.0	MHz	
One Horizontal Line	th	1026	1056	1086	DCLK	
HS pulse width	thpw	-	30	-	DCLK	
HS Blanking	thb	-	16	-	DCLK	
HS Front Porch	thfp	180	210	240	DCLK	

Item	Symbol	Values			Unit	Remark
		Min.	Typ.	Max.		
Vertical Display Area	tvd	-	480	-	TH	
VS period time	tv	515	525	535	TH	
VS pulse width	tvpw	-	13	-	TH	
VS Blanking	tvb	-	10	-	TH	
VS Front Porch	tvfp	12	22	32	TH	



## 8.4 Data input format

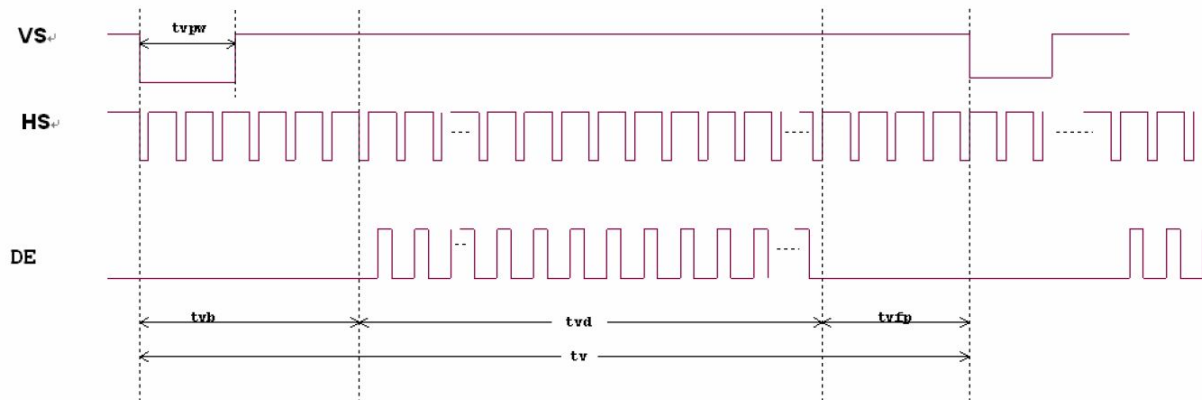

## 9. Standard Specification for Reliability

### 9.1 Standard Specification for Reliability of LCD Module

Item	Test Conditions	Remark
High temperature storage	Ta=80°C 240hrs	NOTE1 , NOTE4
Low temperature storage	Ta=-30°C 240hrs	NOTE1 , NOTE4
High temperature operation	Ta=70°C 240hrs	NOTE2 , NOTE4
Low temperature operation	Ta=-20°C 240hrs	NOTE2 , NOTE4
Operate at high temperature and humidity	+60°C, 90%RH 240hrs	NOTE4
Thermal Shock	-30°C/30min~+80°C/30min for a total 100 cycles, start with cold temperature and end with high temperature.	NOTE4
Vibration Test	Frequency range:10~55HZ Stroke:1.5mm Swap:10HZ~55HZ~10HZ 2 hours of each direction of X.Y. Z (6 hours for total)	
Mechanical shock	100G 6ms, ±X, ±Y, ±Z 3 times for each direction	
Package vibration test	Random vibration :0.15G*G/HZ from 5-200 HZ,-6dB/Octave from 200-500HZ of each direction of X.Y. Z (6 hours for total)	
Low temperature storage	Height:60cm 1 corner ,3 edges ,6 surfaces	
Low temperature storage	±2KV ,Human Body Mode, 100pF/1500Ω	

Note 1: Ta is the ambient temperature of samples.

Note 2: Ts is the temperature of panel's surface.

Note 3: In the standard condition, there shall be no practical problem that may affect the display function. After the reliability test, the product only guarantees operation, but don't guarantee all of the cosmetic specification.

Note 4: Before cosmetic and function test, the product must have enough recovery time, at least 2 hours at room temperature.

## 10. General Precautions

### 10.1. Safety

- Liquid crystal is poisonous. Do not put it in your mouth. If liquid crystal touches your skin or clothes, wash it off immediately by using soap and water.

### 10.2. Handling

- The LCD panel is plate glass. Do not subject the panel to mechanical shock or to excessive force on its surface.
- The polarizer attached to the display is easily damaged. Please handle it carefully to avoid scratch or other damages.
- To avoid contamination on the display surface, do not touch the module surface with bare hands.
- Keep a space so that the LCD panels do not touch other components.
- Put cover board such as acrylic board on the surface of LCD panel to protect panel from damages.
- Transparent electrodes may be disconnected if you use the LCD panel under environmental conditions where the condensation of dew occurs.
- Do not leave module in direct sunlight to avoid malfunction of the ICs.

### 10.3. Static Electricity

- Be sure to ground module before turning on power or operating module.
- Do not apply voltage which exceeds the absolute maximum rating value.

### 10.4. Storage

- Store the module in a dark room where must keep at  $25\pm 10^{\circ}\text{C}$  and 65%RH or less.
- Do not store the module in surroundings containing organic solvent or corrosive gas.
- Store the module in an anti-electrostatic container or bag.

### 10.5. Cleaning

- Do not wipe the polarizer with dry cloth. It might cause scratch.
- Only use a soft sloth with IPA to wipe the polarizer, other chemicals might permanent damage to the polarizer.

## 11. Packing Method

----TBD