



**SPECIFICATION
FOR
LCD MODULE**

**MODULE NO: AFY320240A0-3.5INTH-C
REVISION NO: C**

Customer's Approval:

--

	SIGNATURE	DATE
PREPARED BY (RD ENGINEER)		
CHECKED BY		
APPROVED BY		

REVISION RECORD

Rev No.	Rev date	Contents	Remarks
O	2019-12-10	First release	Preliminary
A	2019-12-27	CHANGE CTP IN page of 6th.	
B	2020-01-07	CHANGE CTP IN page of 6th.	
C	2020-03-30	CHANGE CTP IC to ST1633	

CONTENTS

1. GENERAL INFORMATION	3
2. ABSOLUTE MAXIMUM RATINGS.....	3
3. ELECTRICAL CHARACTERISTICS.....	4
4. BACKLIGHT CHARACTERISTICS	4
5. TOUCH PANEL CHARACTERISTICS.....	4
6. EXTERNAL DIMENSIONS	5
7. ELECTRO-OPTICAL CHARACTERISTICS.....	6
8. INTERFACE DESCRIPTION.....	8
9. ELECTRICAL CHARACTERISTICS.....	9
10. POWER SEQUENCE.....	14
11. RELIABILITY TEST CONDITIONS	15
12. INSPECTION CRITERION.....	16
13. HANDLING PRECAUTIONS	16
14. PRECAUTION FOR USE.....	17
15. PACKING SPECIFICATION.....	17
16. HSF COMPLIANCE	17

1. GENERAL INFORMATION

No.	Item	Contents	Unit
1	LCD size	3.5 inch (Diagonal)	/
2	Display mode	a-si TFT&CTP/Normally black/Transmissive	/
3	Viewing direction(eye)	Free	/
4	Gray scale inversion direction	-	/
5	Resolution(H*V)	320 *240 Pixels (TFT)/ 320*240 Dots (CTP)	Pixels
6	Module size (L*W*H)	76.90*63.90*4.67	mm
7	Active area (L*W)	70.08*52.56	mm
8	Pixel pitch (L*W)	0.219*0.219	mm
9	Interface type	RGB 24bit interface (TFT)/I2C(CTP)	/
10	Color Depth	16.7M	/
11	Module power consumption	0.83	W
12	Back light type	LED	/
13	Driver IC	ST7272 OR COMPATIBLE(TFT) ST1633(CTP)	/
14	Weight	TBD	G

2. ABSOLUTE MAXIMUM RATINGS

Item	Symbol	Min.	Max.	Unit	Note
Power supply input voltage for TFT	VDD	-0.3	4.0	V	
Power supply input voltage for CTP	VCC	-0.3	3.6	V	
Backlight current (normal temp.)	ILED	-	50	mA	
Operation temperature	Top	-20	+70	°C	Note1
Storage temperature	Tst	-30	+80	°C	Note1
Humidity	RH	20%	90%	/	Note1

Note1 :

- 1).The relative humidity and temperature range are as below sketch,90%RH Max.
- 2).The maximum wet bulb temperature $\leq 40^{\circ}\text{C}$ and without dewing.

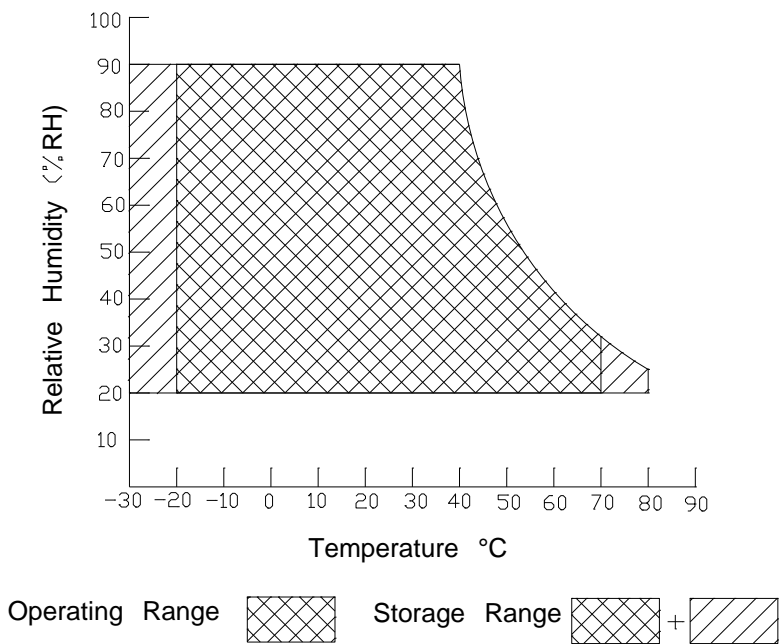

3. ELECTRICAL CHARACTERISTICS

TFT DC CHARACTERISTICS(at Ta=25°C)

Item	Symbol	Min.	Typ.	Max.	Unit	Note
Power supply input voltage	VDD	3.0	3.3	3.6	V	
I/O logic voltage	VDDIO	-	-	-	V	
Input voltage 'H' level	VIH	0.7VDDIO	-	VDDIO	V	
Input voltage 'L' level	VIL	VSS	-	0.3VDDIO	V	
Power supply current	IVDD	-	30	-	mA	
TFT gate on voltage	VGH	-	-	-	V	
TFT gate off voltage	VGL	-	-	-	V	
Analog power supply voltage	AVDD	-	-	-	V	
Differential input common mode voltage	Vcom	-	-	-	V	Note1

Note1 : The value is just the reference value. The customer can optimize the setting value by the different D-IC
Vcom must be adjusted to optimize display quality, as Crosstalk and Contrast Ratio etc..

CTP DC CHARACTERISTICS(at Ta=25°C)

Item	Symbol	Min.	Typ.	Max.	Unit	Note
Power supply input voltage	VCC	2.6	3.3	3.6	V	Note2
Input Power ripple	Vpp	-	-	50	mV	
I/O Signal Voltage	VCCIO	-	3.3	-	V	Note2
Input voltage 'H' level	VIH	0.7VCCIO	-	VCCIO	V	
Input voltage 'L' level	VIL	VSS	-	0.3VCCIO	V	
Operating Current (Normal Mode)	IVCC	-	-	-	mA	
Operating Current (Sleep mode)	IVCC	-	-	-	mA	

Note2 : If you need more information of CTP, please refer to our Spec of CTP.

4. BACKLIGHT CHARACTERISTICS

(at Ta=25°C, RH=60%)

Item	Symbol	Min.	Typ.	Max.	Unit	Note
LED forward voltage	VF	17.4	18.0	18.6	V	IF=20*2mA
LED forward current	IF	-	40	-	mA	
LED power consumption	PLED	-	0.72	-	W	Note1
Number of LED	-		6		PCS	
Connection mode	-	3 in series 2 in parallel			/	
LED life-time	-	20000	-	-	Hrs	Note2

Note1 : Calculator value for reference : IF*VF = PLED

Note2 : The LED life-time define as the estimated time to 50% degradation of initial brightness at Ta=25°C and IF =40mA. The LED lifetime could be decreased if operating IF is larger than 40mA.

5. TOUCH PANEL CHARACTERISTICS

(at Ta=25°C)

Item	Description	Remark
ProductStructure	G+G	
Surface Hardness	≤6H	Pencil, Loading 500g, 45 deg
Ball-falling Test	≤100cm	Steel ball weight 64g
Touch Count Max	5 point	
I2C Slave Address*	-	
Origin of Coordinate*	top left corner	
FW version		

6. EXTERNAL DIMENSIONS

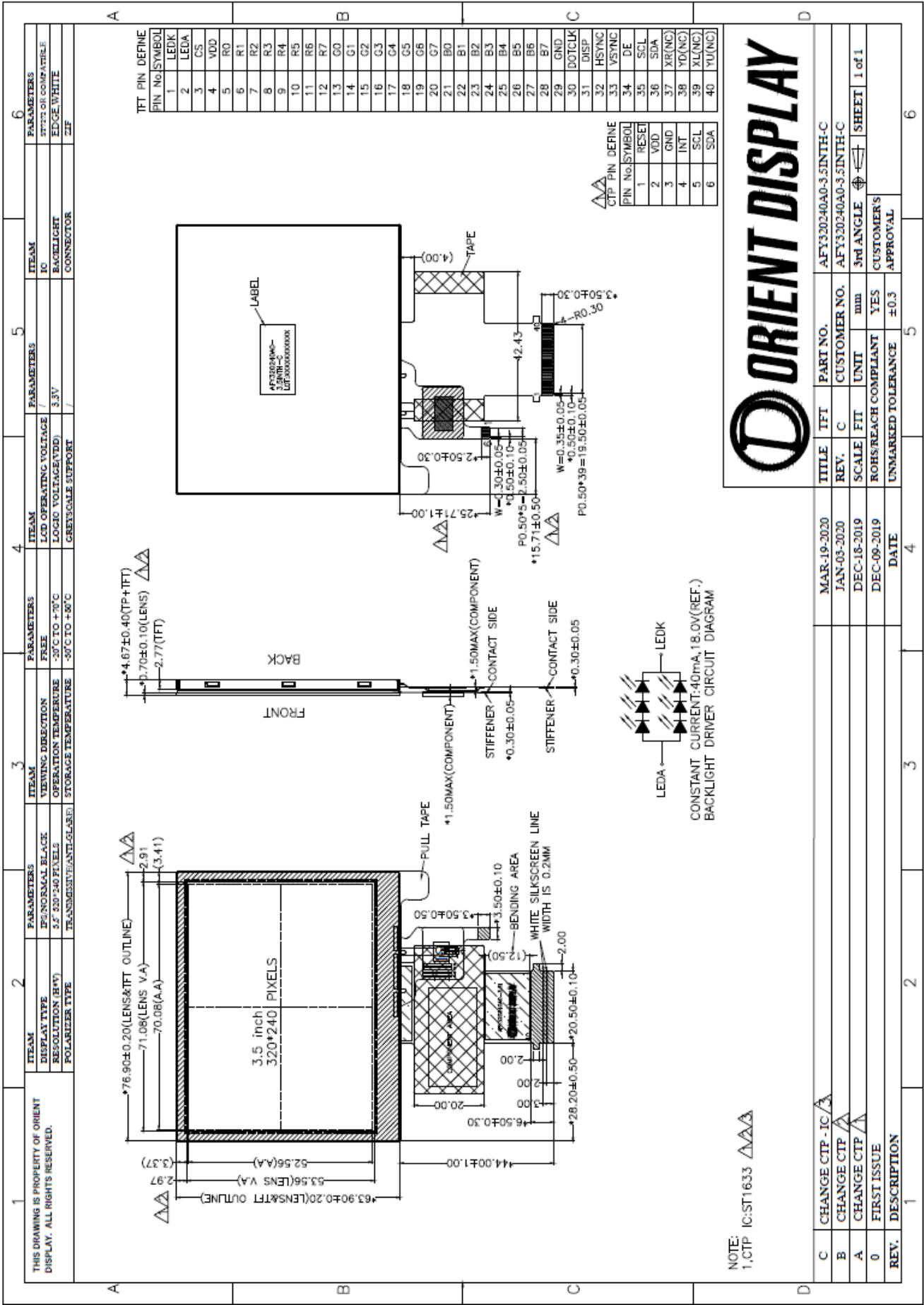

7. ELECTRO-OPTICAL CHARACTERISTICS

Item	Symbol	Condition	Min.	Typ.	Max.	Unit	Remark	Note
Response time	Tr+ Tf	-	-	30	40	ms	FIG.1	Note 1
Contrast ratio	Cr		640	800	-	-	FIG.2	Note 2
Surface luminance	Lv	$\theta=0^\circ$	600	800	-	cd/m ²	FIG.2	Note 3
Luminance uniformity	Yu	$\theta=0^\circ$	75	80	-	%	FIG.2	Note 4
NTSC	-	$\theta=0^\circ$	-	50	-	%	FIG.2	Note 5
Viewing angle	θ	$\varnothing=90^\circ$	70	80	-	deg	FIG.3	Note 6
		$\varnothing=270^\circ$	70	80	-	deg	FIG.3	
		$\varnothing=0^\circ$	70	80	-	deg	FIG.3	
		$\varnothing=180^\circ$	70	80	-	deg	FIG.3	
CIE (x,y) chromaticity	Red x	$\theta=0^\circ$ $\varnothing=0^\circ$ Ta=25°C	Typ -0.04	TBD	Typ +0.04	-	FIG.2 CIE1931	Note 5
	Red y			TBD		-		
	Green x			TBD		-		
	Green y			TBD		-		
	Blue x			TBD		-		
	Blue y			TBD		-		
	White x			TBD		-		
	White y			TBD		-		

Note1. Definition of response time

The response time is defined as the LCD optical switching time interval between “White” state and “Black” state. Rise time (T_{ON}) is the time between photo detector output intensity changed from 90% to 10%. And fall time (T_{OFF}) is the time between photo detector output intensity changed from 10% to 90%. For additional information see FIG1.

Note2. Definition of contrast ratio

Contrast ratio(Cr) is defined mathematically by the following formula. For more information see FIG.2.

$$\text{Contrast ratio} = \frac{\text{Luminance measured when LCD on the "White" state}}{\text{Luminance measured when LCD on the "Black" state}}$$

Measured at the center area of the LCD

Note3. Definition of surface luminance

Surface luminance is the luminance with all pixels displaying white. For more information see FIG.2.

L_v = Average Surface Luminance with all white pixels(P1,P2,P3,,Pn)

Note4. Definition of luminance uniformity

The luminance uniformity in surface luminance is determined by measuring luminance at each test position 1 through n, and then dividing the maximum luminance of n points luminance by minimum luminance of n points luminance. For more information see FIG.2.

$$Y_u = \frac{\text{Minimum surface luminance with all white pixels (P1,P2,P3,.....,Pn)}}{\text{Maximum surface luminance with all white pixels (P1,P2,P3,.....,Pn)}}$$

Note5. Definition of color chromaticity (CIE1931)

CIE (x,y) chromaticity, The x,y value is determined by screen active area center position P5. For more information see FIG.2.

Note6. Definition of viewing angle

Viewing angle is the angle at which the contrast ratio is greater than 10. angles are determined for the horizontal or x axis and the vertical or y axis with respect to the z axis which is normal to the LCD surface. For more information see FIG.3.

For viewing angle and response time testing, the testing data is base on Autronic-Melchers's ConoScope or DMS series Instruments or compatible. For contrast ratio, Surface Luminance, Luminance uniformity and CIE, the testing data is base on TOPCON's BM-5or BM-7 photo detector or compatible.

FIG.1. The definition of response Time

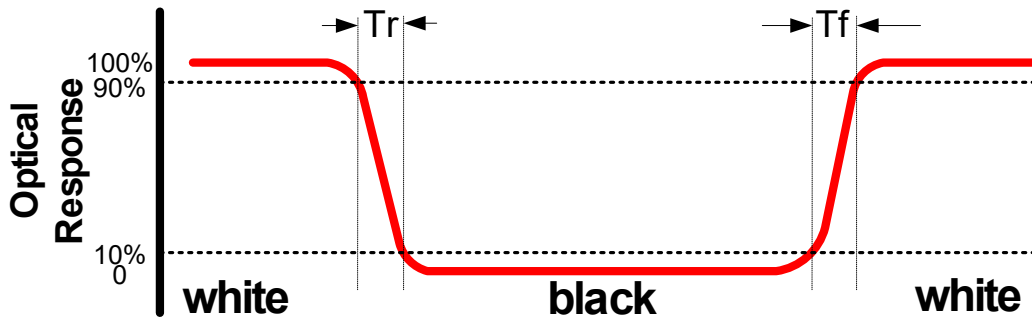

FIG.2. Measuring method for contrast ratio, surface luminance, luminance uniformity, CIE (x,y) chromaticity

H,V : Active area

Light spot size $\varnothing=1.5\text{mm}$ (BM-7)50cm distance or compatible distance from the LCM surface to detector lens.

Test spot position : see Figure a.

measurement instrument : TOPCON's luminance meter BM-7 or compatible ,see Figure b.

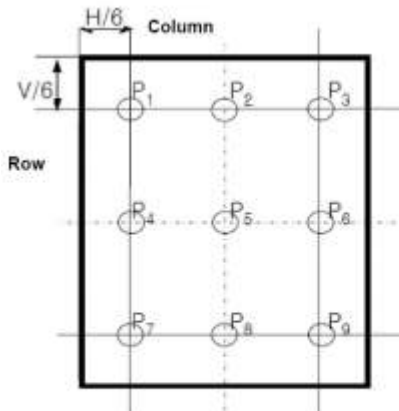

Figure a

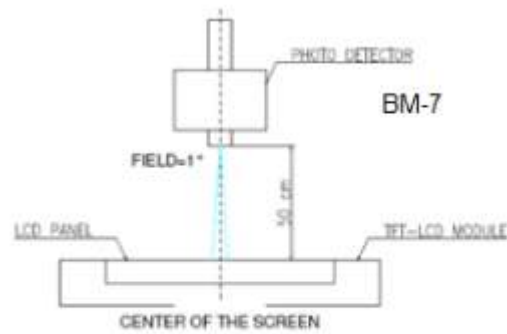
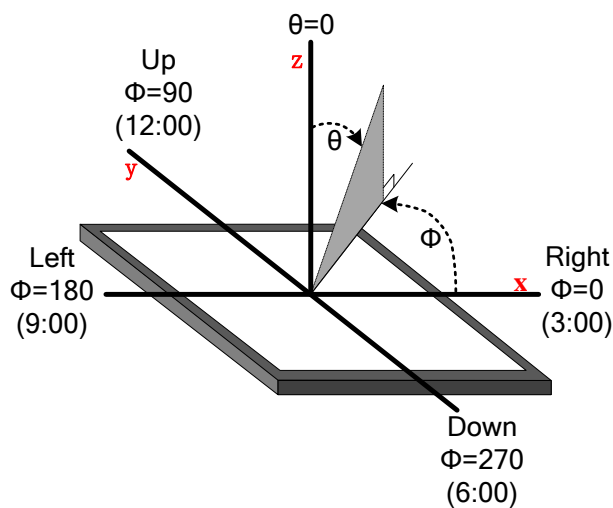

Figure b

FIG.3. The definition of viewing angle



8. INTERFACE DESCRIPTION

TFT Module Interface description

Interface No.	Name	I/O or connect to	Description
1	LEDK	P	Power for LED backlight(Cathode)
2	LEDA	P	Power for LED backlight(Anode)
3	CS	I	Ground
4	VDD	P	Power for LCD
5-12	Red(0-7)	I	Red data
13-20	Green(0-7)	I	Green data
21-28	Blue(0-7)	I	Blue data
29	GND	P	Ground
30	DOTCLK	I	Dot clock
31	DISP	I	Display on/off
32	HSYNC	I	Horizontal sync input.
33	VSYNC	I	Vertical sync input
34	DE	I	Data enable
35	SCL	I	SPI3 Serial O'clock input signal
36	SDA	I/O	SPI3 data input signal
37	XR/NC	/	/
38	YD/NC	/	/
39	XL/NC	/	/
40	YU/NC	/	/

CTP interface description

Interface No.	Name	I/O or connect to	Description
1	RESET	I	Reset low
2	VDD	P	Power Supply of CTP
3	GND	P	Ground
4	INT	I	State change interrupt
5	SCL	I	Serial interface clock
6	SDA	I/O	Serial interface date

9. ELECTRICAL CHARACTERISTICS

TFT Module AC CHARACTERISTICS

3-wire Serial Interface

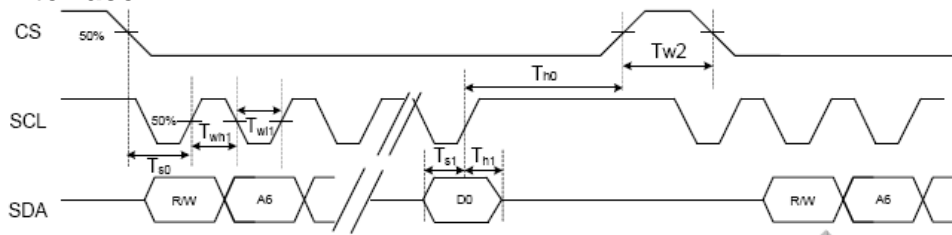

Item	Symbol	Min.	Typ.	Max.	Unit	Conditions
CS Input Setup Time	Ts0	50	-	-	ns	
Serial Data Input Setup Time	Ts1	50	-	-	ns	
CS Input Hold Time	Th0	50	-	-	ns	
Serial Data Input Hold Time	Th1	50	-	-	ns	
SCL Write Pulse High Width	Twh1	50	-	-	ns	
SCL Write Pulse Low Width	Twl1	50	-	-	ns	
SCL Read Pulse High Width	Trh1	300			ns	
SCL Read Pulse Low Width	Trl1	300			ns	
CS Pulse High Width	Tw2	400	-	-	ns	

R/W: Read/Write mode control bit.

R/W=1: Read mode

R/W=0: Write mode

Read Mode

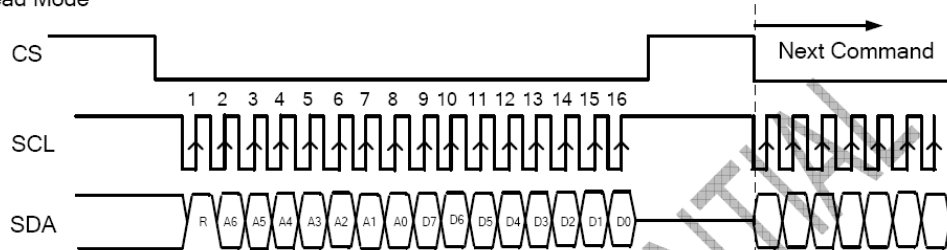

Write Mode

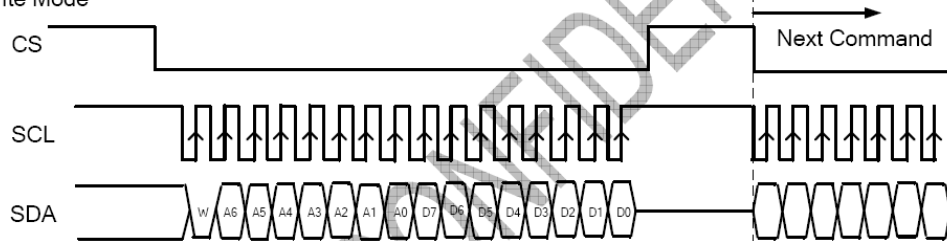

- a. Each serial command consists of 16 bits of data which is loaded one bit a time at the rising edge of serial clock SCL.
- b. Command loading operation starts from the falling edge of CS and is completed at the next rising edge of CS.
- c. The serial control block is operational after power on reset, but commands are established by the VSYNC signal. If command is transferred multiple times for the same register, the last command before the VSYNC signal is valid.
- d. If less than 16 bits of SCL are input while CS is low, the transferred data is ignored.
- e. If 16 bits or more of SCL are input while CS is low, the previous 16 bits of transferred data before then rising edge of CS pulse are valid data.
- f. Serial block operates with the SCL clock
- g. Serial data can be accepted in the power save mode.
- h. After power on reset or GRB reset, it is required 100ms delay to begin SPI communication.

RGB Interface

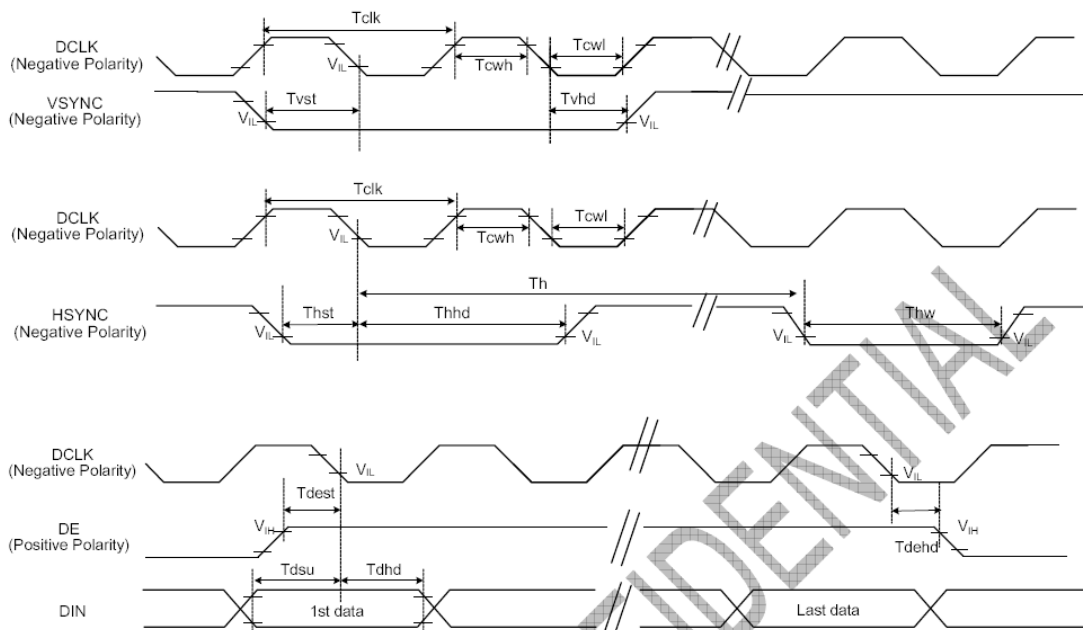

Item	Symbol	Min.	Typ.	Max.	Unit	Conditions
CLK Pulse Duty	Tclk	40	50	60	%	
HSYNC Width	Thw	2	-	-	DCLK	
HSYNC Period	Th	55	60	65	us	
VSYNC Setup Time	Tvst	12	-	-	ns	
VSYNC Hold Time	Tvhd	12	-	-	ns	
HSYNC Setup Time	Thst	12	-	-	ns	
HSYNC Hold Time	Thhd	12	-	-	ns	
Data Setup Time	Tdsu	12	-	-	ns	
Data Hold Time	Tdhd	12	-	-	ns	
DE Setup Time	Tdst	12	-	-	ns	
DE Hold Time	Tdehd	12	-	-	ns	

Parallel 24-bit RGB Input Timing Table							
Item	Symbol	Min.	Typ.	Max.	Unit	Note	
DCLK Frequency	Fclk	5	6	8	MHz		
DCLK Period	Tclk	125	167	200	ns		
HSYNC	Period Time	Th	325	371	438	DCLK	
	Display Period	Thdisp		320		DCLK	
	Back Porch	Thbp	3	43	43	DCLK	SYNC mode back porch control by H_BLANKING[7:0] setting Thbp= H_BLANKING[7:0]
	Front Porch	Thfp	2	8	75	DCLK	
	Pulse Width	Thw	2	4	43	DCLK	
VSYNC	Period Time	Tv	244	260	289	HSYNC	
	Display Period	Tvdisp		240		HSYNC	
	Back Porch	Tvbp	2	12	12	HSYNC	SYNC mode back porch control by V_BLANKING[7:0] setting Tvbp= V_BLANKING[7:0]
	Front Porch	Tvfp	2	8	37	HSYNC	
	Pulse Width	Tvw	2	4	12	HSYNC	

Note: It is necessary to keep Tvbp =12 and Thbp =43 in sync mode. DE mode is unnecessary to keep it.

SYNC Mode

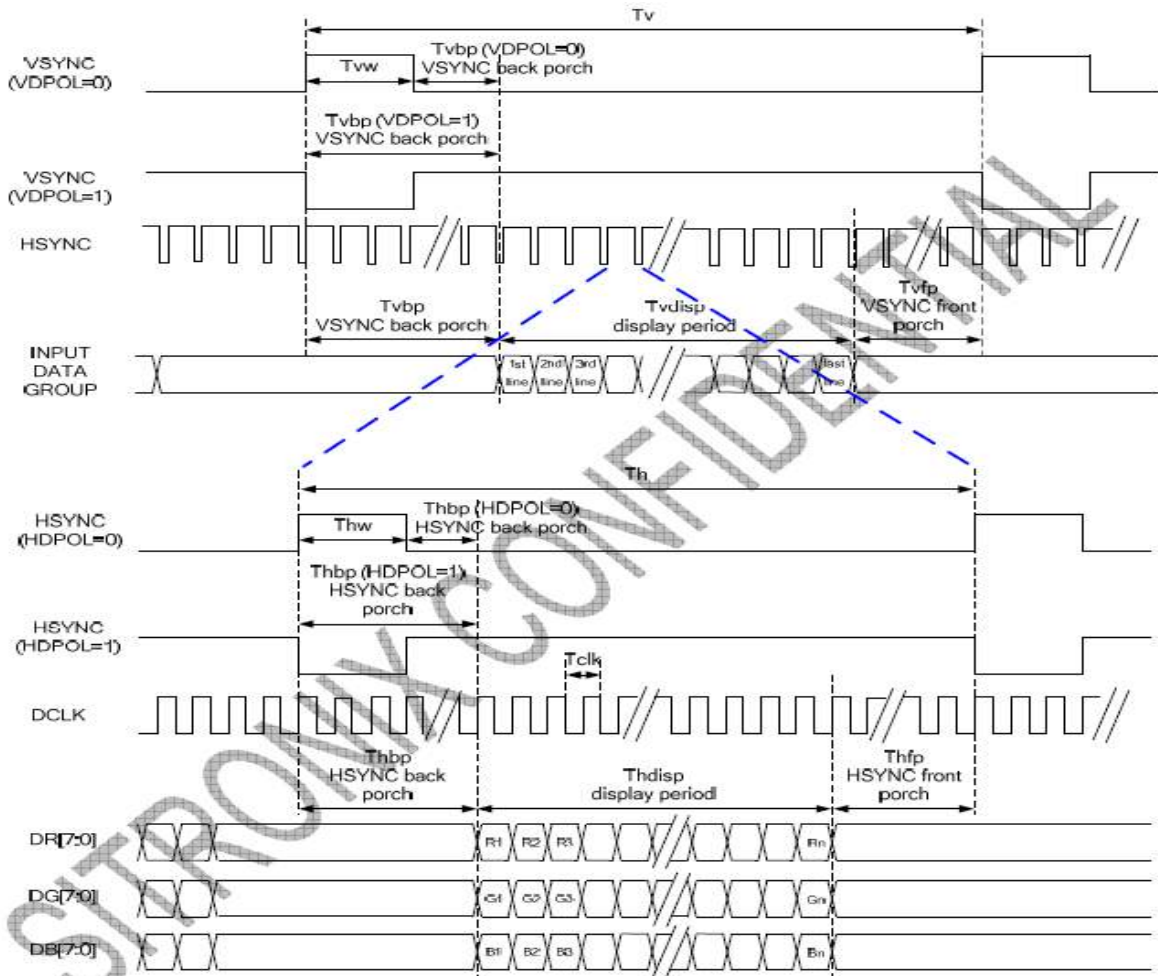

SYNC-DE Mode

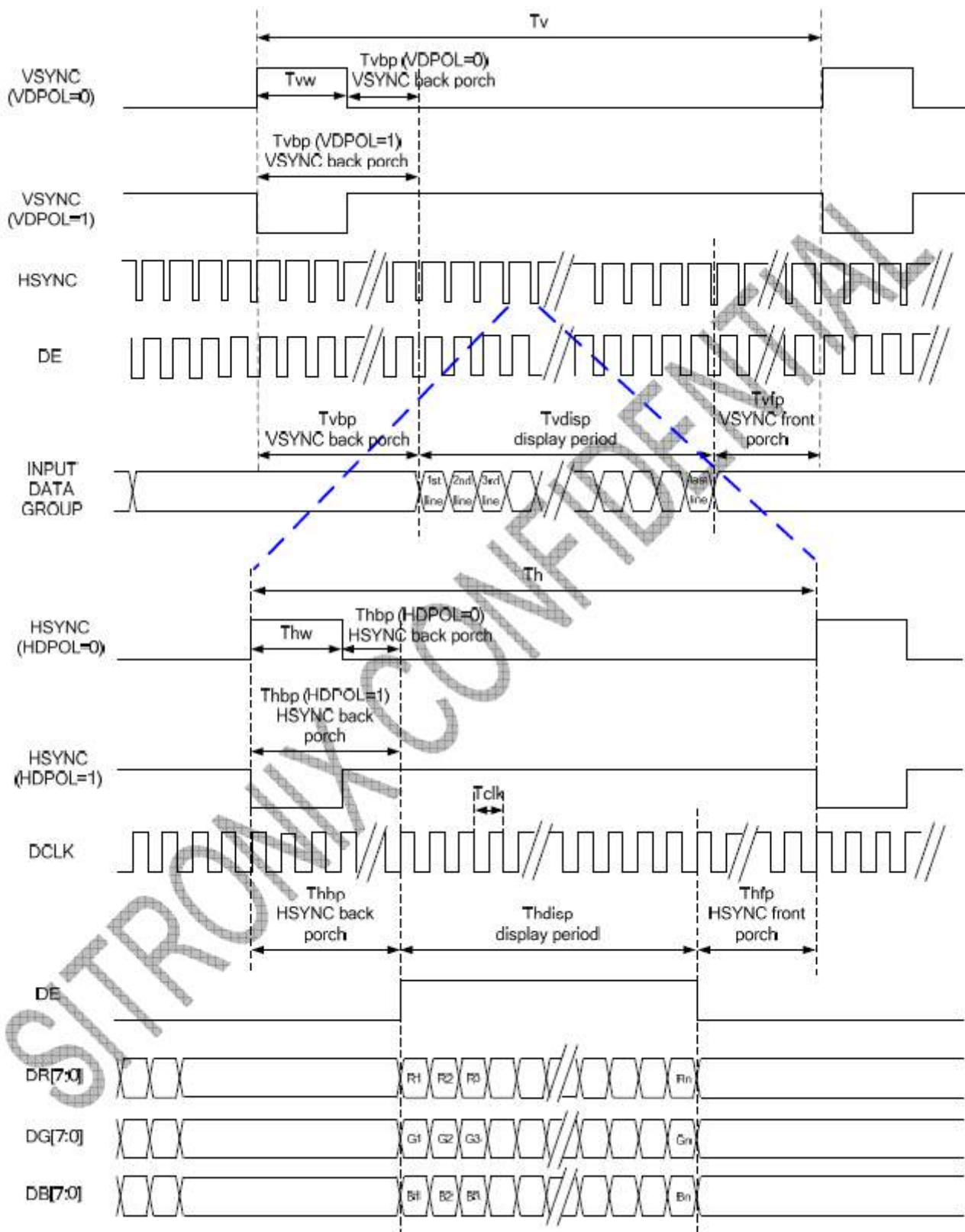

DE Mode

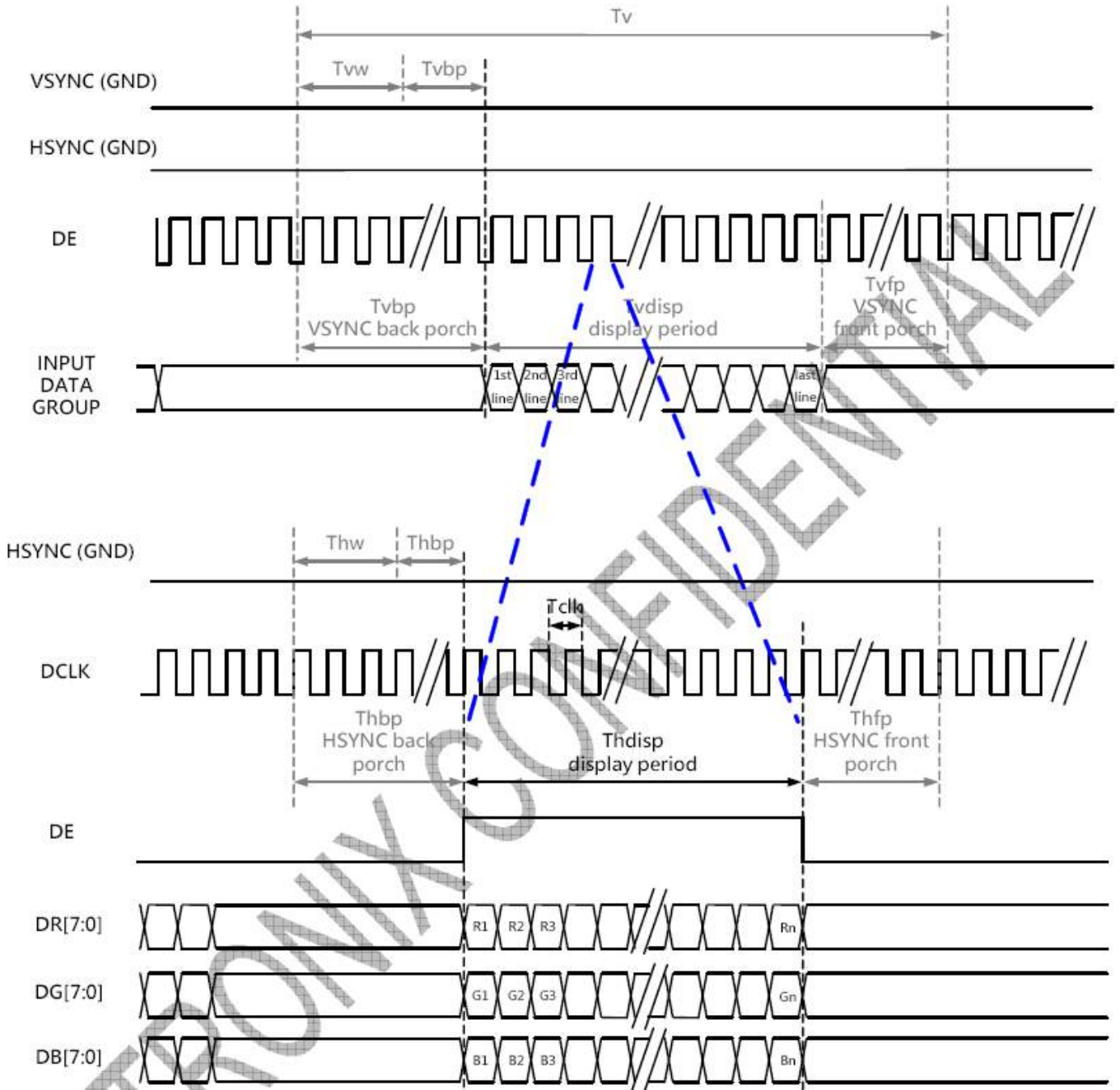

10. POWER SEQUENCE

10.1 TFT Module POWER SEQUENCE

10.1.1 Power On Sequence

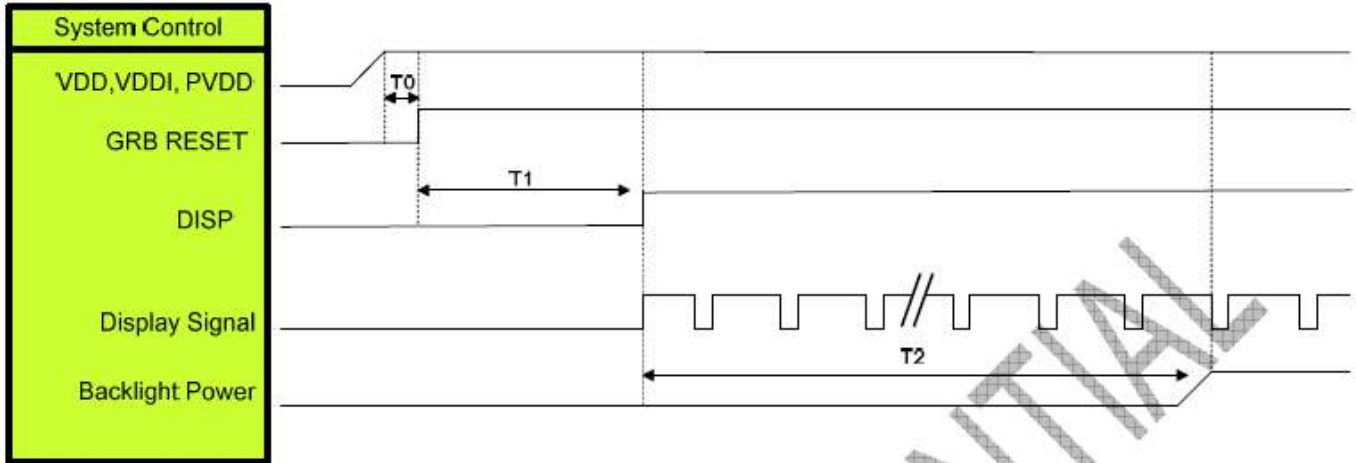

Symbol	Description	Min. Time	Unit
T0	System power stability to GRB RESET signal	0	ms
T1	GRB RESET= "High" to DISP="High"	10	ms
T2	Display Signal output to Backlight Power on	250	ms

Note: Display signal: DCLK; VSYNC; HSYNC; DE; DR[7:0]; DG[7:0]; DB[7:0]

10.1.2 Power OFF Sequence

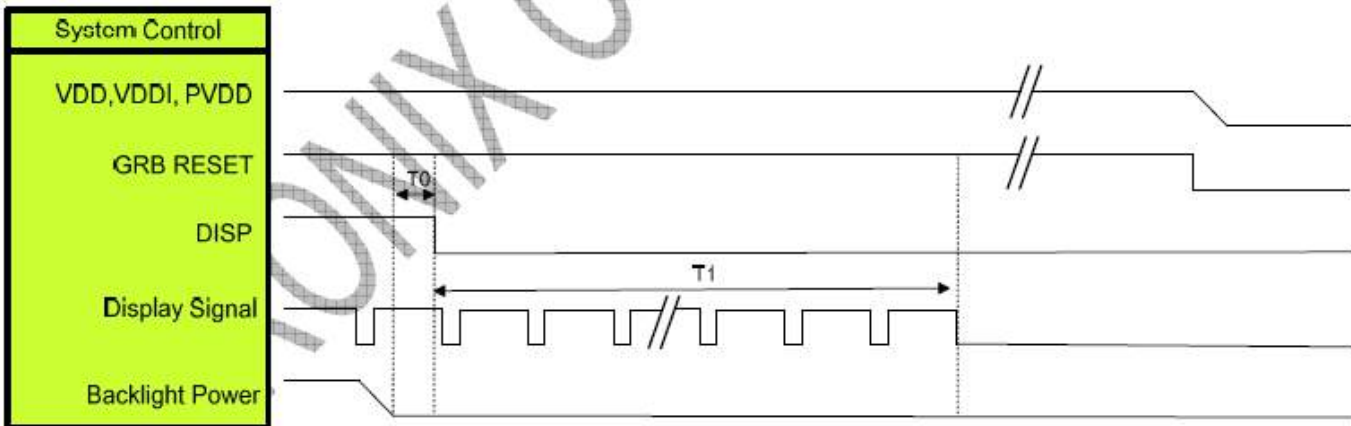

Symbol	Description	Min. Time	Unit
T0	Backlight Power off to DISP="Low"	5	ms
T1	DISP="Low" to IC internal voltage discharge complete	80	ms

Note: Display signal: DCLK; VSYNC; HSYNC; DE; DR[7:0]; DG[7:0]; DB[7:0]

11. RELIABILITY TEST CONDITIONS

No.	Test item	Test condition	Inspection after test	
11.1	High temperature storage test	+80°C/240 hours	Inspection after 2~4hours storage at room temperature, the sample shall be free from defects : 1.Current changing value before test and after test is 50% larger; 2. Function defect : Non-display,abnormal-d isplay,missing lines, Short lines,I/O corrosion; 3.Visual defect : Air bubble in the LCD,Seal leak,Glass crack.	
11.2	Low temperature storage test	-30°C/240 hours		
11.3	High temperature operating test	+70°C/120 hours		
11.4	Low temperature operating test	-20°C/120 hours		
11.5	Temperature cycle storage test	-30°C ~ 25°C ~ +80°C/10cycles (30min.) (10min.) (30min.)		
11.6	High temperature high humidity test	+50°C*90% RH/120 hours		
11.7	Vibration test	Frequency : 250 r/min Amplitude : 1 inch Time: 45min		
11.8	Drop test	Drop direction: 1 corner/3 edges/6 sides 10 times		
		Packing weight(kg)		Drop height(cm)
		<11		80±1.6
		11≤G<21	60±1.2	
		21≤G<31	50±1.0	
		31≤G<40	40±0.8	
11.9	ESD test	Air discharge: ±8KV, 10times Contact discharge: ±4KV, 10times		
Remark : 1.The test samples should be applied to only one test item. 2.Sample size for each test item is 3~5pcs. 3.For High temperature high humidity test, Pure water(Resistance>10MΩ) should be used. 4.In case of malfunction defect caused by ESD damage, if it would be recovered to normal state after resetting, it would be judged as a good part. 5.B/L evaluation should be excepted from reliability test with humidity and temperature: Some defects such as black spot/blemish can happen by natural chemical reaction with humidity and Fluorescence B/L has. 6.Failure judgment criterion: Basic specification, Electrical characteristic, Mechanical characteristic, Optical characteristic.				

12. INSPECTION CRITERION

Refer to 《Inspection Criterion for TFT》 V2.3

13. HANDLING PRECAUTIONS

13.1 Mounting method

The LCD module consists of two thin glass plates with polarizers which easily be damaged. And since the module is so constructed as to be fixed by utilizing fitting holes in the printed circuit board.

Extreme care should be needed when handling the LCD modules.

13.2 Caution of LCD handling and cleaning

When cleaning the display surface, Use soft cloth with solvent [recommended below] and wipe lightly :

- .Isopropyl alcohol
- .Ethyl alcohol

Do not wipe the display surface with dry or hard materials that will damage the polarizer surface.

Do not use the following solvent :

- .Water
- .Aromatics

Do not wipe ITO pad area with the dry or hard materials that will damage the ITO patterns

Do not use the following solvent on the pad or prevent it from being contaminated :

- .Soldering flux
- .Chlorine (Cl) , Sulfur (S)

If goods were sent without being silicon coated on the pad, ITO patterns could be damaged due to the corrosion as time goes on.

If ITO corrosion happens by miss-handling or using some materials such as Chlorine (Cl), Sulfur (S) from customer, Responsibility is on customer.

13.3 Caution against static charge

The LCD module use C-MOS LSI drivers, so we recommended that you :

Connect any unused input terminal to Vdd or Vss, do not input any signals before power is turned on, and ground your body, work/assembly areas, assembly equipment to protect against static electricity.

13.4 Packing

Module employ LCD elements and must be treated as such.

- .Avoid intense shock and falls from a height.
- .To prevent modules from degradation, do not operate or store them exposed direct to sunshine or high temperature/humidity.

13.5 Caution for operation

- .It is an indispensable condition to drive LCD's within the specified voltage limit since the higher voltage than the limit cause the shorter LCD life.
- .An electrochemical reaction due to direct current causes LCD's undesirable deterioration, so that the use of direct current drive should be avoided.
- .Response time will be extremely delayed at lower temperature than the operating temperature range and on the other hand at higher temperature LCD's show dark color in them. However those phenomena do not mean malfunction or out of order with LCD's, which will come back in the specified operation temperature.
- .If the display area is pushed hard during operation, some font will be abnormally displayed but it resumes normal condition after turning off once.
- .A slight dew depositing on terminals is a cause for electro-chemical reaction resulting in terminal open circuit.
- .Usage under the maximum operating temperature, 50%Rh or less is required.
- .When fixed patterns are displayed for a long time, remnant image is likely to occur.

13.6 Storage

In the case of storing for a long period of time for instance, for years for the purpose or replacement use, the following ways are recommended.

- .Storing in an ambient temperature 10°C to 30°C, and in a relative humidity of 45% to 75%. Don't expose to sunlight or fluorescent light.
- .Storing in a polyethylene bag with the opening sealed so as not to enter fresh air outside in it . And with no desiccant.
- .Placing in a dark place where neither exposure to direct sunlight nor light's keeping the storage temperature range.
- .Storing with no touch on polarizer surface by anything else.

It is recommended to store them as they have been contained in the inner container at the time of delivery from us.

13.7 Safety

- .It is recommendable to crash damaged or unnecessary LCD's into pieces and wash off liquid crystal by either of solvents such as acetone and ethanol, which should be burned up later.
- .When any liquid leaked out of a damaged glass cell comes in contact with your hands, please wash it off well with soap and water.

14. PRECAUTION FOR USE

14.1 A limit sample should be provided by the both parties on an occasion when the both parties agreed its necessity. Judgment by a limit sample shall take effect after the limit sample has been established and confirmed by the both parties.

14.2 On the following occasions, the handing of problem should be decided through discussion and agreement between responsible of the both parties.

- .When a question is arisen in this specification.
- .When a new problem is arisen which is not specified in this specifications.
- .When an inspection specifications change or operating condition change in customer is reported to ODNA, and some problem is arisen in this specification due to the change.
- .When a new problem is arisen at the customer's operating set for sample evaluation in the customer site.

15. PACKING SPECIFICATION

Please consult our technical department for detail information.

16. HSF COMPLIANCE

- .This products complies with ROHS 2011/65/EU and 2015/863/EU、REACH 1907/2006/EC requirements, and the packaging complies with 94-62-EC.