



**SPECIFICATION
FOR
LCD MODULE**

**MODULE NO: AFY1024600A0-7.0INTH
REVISION NO: E**

Customer's Approval:

--

	SIGNATURE	DATE
PREPARED BY (RD ENGINEER)		
CHECKED BY		
APPROVED BY		

CONTENTS

1. GENERAL INFORMATION.....	4
2. ABSOLUTE MAXIMUM RATINGS.....	4
3. ELECTRICAL CHARACTERISTICS.....	4
4. BACKLIGHT CHARACTERISTICS.....	4
5. EXTERNAL DIMENSIONS.....	5
6. ELECTRO-OPTICAL CHARACTERISTICS.....	6
7. INTERFACE DESCRIPTION.....	9
8. AC CHARACTERISTICS.....	10
9. POWER SEQUENCE.....	14
10. RELIABILITY TEST CONDITIONS.....	15
11. INSPECTION CRITERION.....	16
12. HANDLING PRECAUTIONS.....	25
13. PRECAUTION FOR USE.....	26
14. PACKING SPECIFICATION.....	26

1.GENERAL INFORMATION

No.	Item	Contents	Unit
1	LCD size	7.0 inch (Diagonal)	/
2	LCD type	IPS/Normally Black	/
3	Viewing direction(eye)	Free	/
4	Resolution(H*V)	1024*600 Pixels	/
5	Module size (L*W*H)	164.8*99.8*5.6	mm
6	Active area (L*W)	154.21*85.92	mm
7	Pixel pitch (L*W)	0.15* 0.15	mm
8	Interface type	LVDS Interface	/
9	Module power consumption	2.1	W
10	Back light type	White LED	/
11	Driver IC	EK79001HN+EK73215BCGA or compatible	/
12	Weight	TBD	g

2.ABSOLUTE MAXIMUM RATINGS

Item	Symbol	Min	Max	Unit
Power supply input voltage (LCM)	VDD	-0.5	5.0	V
Backlight current (normal temp.)	ILED	-	600	mA
Operation temperature	Top	-20	70	°C
Storage temperature	Tst	-30	80	°C
Humidity	RH	-	90%(Max60°)	RH

3. ELECTRICAL CHARACTERISTICS

DC CHARACTERISTICS (at Ta=25°C)

Item	Symbol	Min	Typ	Max	Unit	Note
Power supply input voltage (LCM)	VDD	2.7	3.3	3.6	V	
I/O logic voltage	VDDIO	N/A	N/A	N/A	V	=VDD
Input voltage 'H' level	VIH	0.7VDD	-	VDD	V	
Input voltage 'L' level	VIL	0	-	0.3VDD	V	
Power supply current	IVDD	-	82	100	mA	
TFT gate on voltage	VGH	-	-	-	V	Built in LCM
TFT gate off voltage	VGL	-	-	-	V	
Analog power supply voltage	AVDD	-	-	-	V	
Differential input common mode voltage	Vcom	-	-	-	V	

4. BACKLIGHT CHARACTERISTICS

(at Ta=25°C,RH=60%)

Item	Symbol	Min.	Typ.	Max.	Unit	Note
LED forward voltage	VF	8.7	9.6	10.5	V	IF=200mA
LED forward current	IF	-	480	-	mA	
LED power consumption	PLED	-	2.88	-	W	Note1
Number of LED	-		24		PCS	
Connection mode	-	3 in series *8 in parallel			/	
LED life-time	-	20000	-	-	Hrs	Note2

Note1.Calculator Value for reference: $IF \cdot VF = PLED$

Note2.The LED Life-time define as the estimated time to 50% degradation of initial brightness at Ta=25°C and IF =480mA. The LED lifetime could be decreased if operating IF is larger than 480mA

Note3. If terminal devices use PWM to control backlight, Please keep the frequency over 500Hz, Otherwise LCD will be easy to show flick

5. EXTERNAL DIMENSIONS

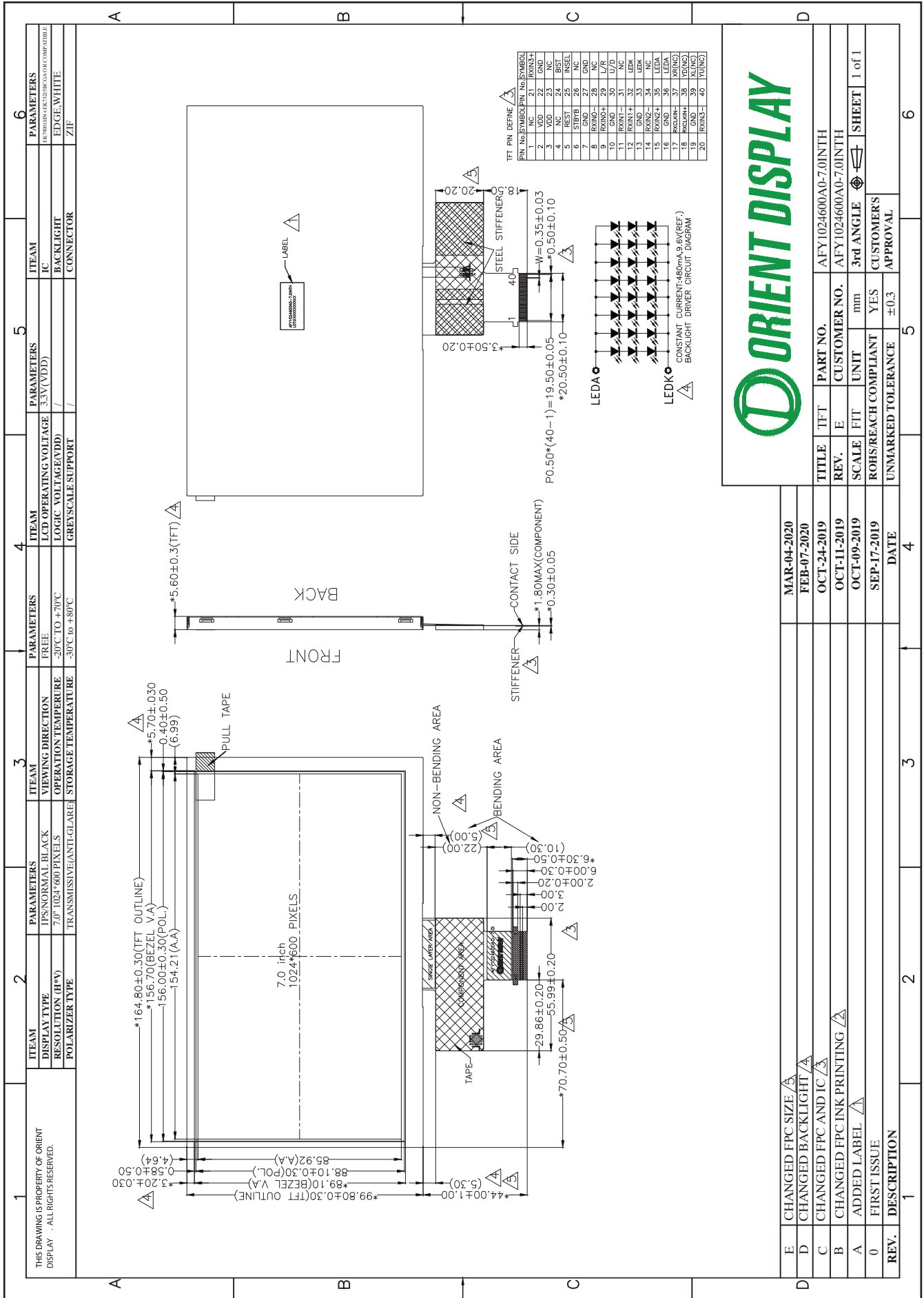

6. ELECTRO-OPTICAL CHARACTERISTICS

Item	Symbol	Condition	Min	Typ	Max	Unit	Remark	Note
Response time	Tr+ Tf	-	-	25	50	ms	FIG.1	Note 4
Contrast ratio	Cr		500	650	-	---	FIG.2	Note 1
Surface Luminance	Lv	$\theta=0^\circ$	800	1000	-	cd/m2	FIG.2	Note 2
Luminance uniformity	-	$\theta=0^\circ$	75	80	-	%	FIG.2	Note 3
NTSC	-	$\theta=0^\circ$	-	50	-	%	FIG.2	Note 5
Viewing angle range	θ	$\varnothing = 90^\circ$	70	80	-	deg	FIG.3	Note 6
		$\varnothing = 270^\circ$	70	80	-	deg	FIG.3	
		$\varnothing = 0^\circ$	70	80	-	deg	FIG.3	
		$\varnothing = 180^\circ$	70	80	-	deg	FIG.3	
CIE (x, y) chromaticity	Red x	$\theta=0^\circ$ $\varnothing=0^\circ$ Ta=25°C	Typ -0.04	TBD	Typ +0.04	-	FIG.2 CIE1931	Note 5
	Red y			TBD		-		
	Green x			TBD		-		
	Green y			TBD		-		
	Blue x			TBD		-		
	Blue y			TBD		-		
	White x			TBD		-		
	White y			TBD		-		

Note1. Definition of contrast ratio

Contrast Ratio(CR) is defined mathematically by the following formula. For more information see FIG.2

$$\text{Contrast Ratio} = \frac{\text{Average Surface Luminance with all white pixels (P1, P2, P3, P4, P5, P6, P7, P8, P9)}}{\text{Average Surface Luminance with all black pixels (P1, P2, P3, P4, P5, P6, P7, P8, P9)}}$$

Note2. Definition of surface luminance

Surface luminance is the LCD surface from the surface with all pixels displaying white. For more information see FIG.2

Lv = Average Surface Luminance with all white pixels(P1, P2, P3, P4, P5, P6, P7, P8, P9)

Note3. Definition of luminance uniformity

The luminance uniformity in surface luminance (δ WHITE) is determined by measuring luminance at each test position 1 through 9, and then dividing the maximum luminance of 9 points luminance by minimum luminance of 9 points luminance. For more information see FIG.2

$$\delta = \frac{\text{Minimum Surface Luminance with all white pixels (P1, P2, P3, P4, P5, P6, P7, P8, P9)}}{\text{Maximum Surface Luminance with all white pixels (P1, P2, P3, P4, P5, P6, P7, P8, P9)}}$$

Note4. Definition of Response time

The response time is defined as the LCD optical switching time interval between "White" state and "Black" state. Rise time (T_{ON}) is the time between photo detector output intensity changed from 90% to 10%. And fall time (T_{OFF}) is the time between photo detector output intensity changed from 10% to 90%. For additional information see FIG1.

Note5. Definition of color chromaticity (CIE1931)

CIE (x, y) chromaticity, The x,y value is determined by screen active area center position P5, For more information see FIG.2

Note6. Definition of Viewing angle

Viewing angle is the angle at which the contrast ratio is greater than 10. angles are determined for the horizontal or x axis and the vertical or y axis with respect to the z axis which is normal to the LCD surface. For more information see FIG.3

For Viewing angle and response time testing, the testing data is base on Autronic-Melchers’s ConoScope or DMS series Instruments or compatible. For contrast ratio, Surface Luminance, Luminance uniformity and CIE,the testing data is base on TOPCON’s BM-5or BM-7 photo detector or compatible.

Note: For TFT module, Gray scale reverse occurs in the direction of panel viewing angle.**The definition of Response Time**

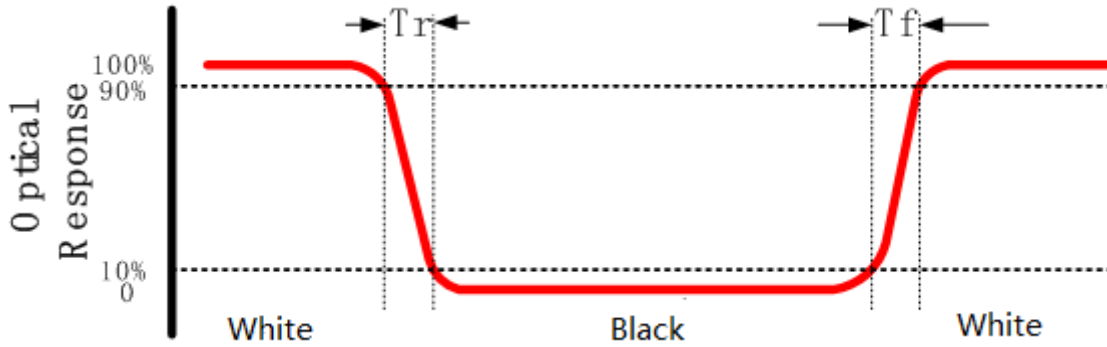

FIG.1. Measuring method for Contrast ratio, surface luminance, Luminance uniformity, CIE (x, y) chromaticity

Size: S≤5”(see Figure a)

A : 5 mm B : 5 mm

H,V : Active Area

Light spot size $\varnothing=5\text{mm}$ (BM-5) or $\varnothing=7.7$

(BM-7)50cm distance or

compatible distance from the LCD surface to detector lens.

test spot position: see Figure a.

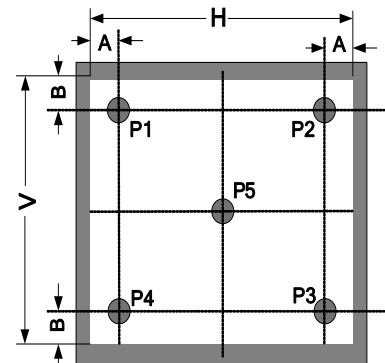

Figure a

measurement instrument : TOPCON’s luminance meter BM-5 or BM-7 or compatible (see Figure c)

Size: $5'' < S \leq 12.3''$ (see Figure b)

H, V : Active Area

Light spot size $\varnothing = 5\text{mm}$ (BM-5) or $\varnothing = 7.7\text{mm}$ (BM-7) 50cm distance or compatible distance from the LCD surface to detector lens

test spot position: see Figure b

measurement instrument : TOPCON's luminance meter BM-5 or

BM-7 or compatible (see Figure c)

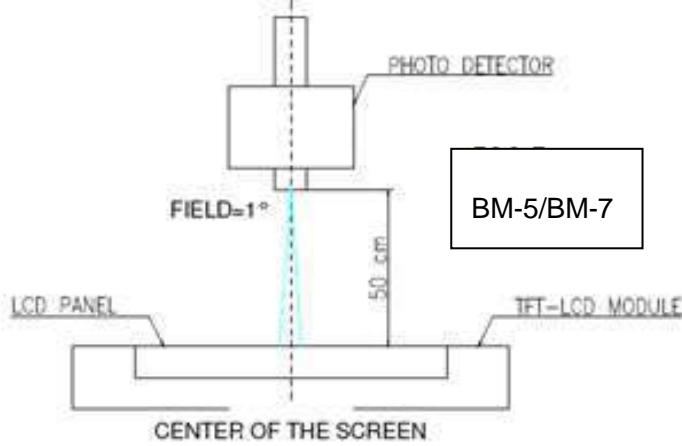
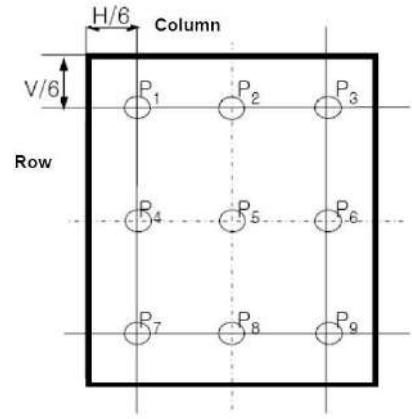
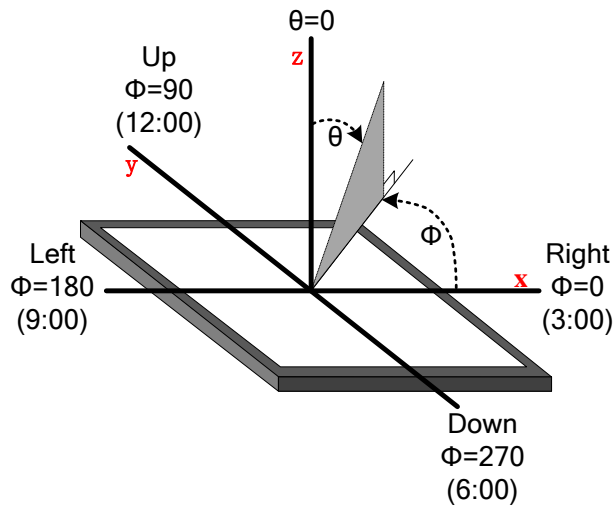

Figure c

FIG.2. The definition of viewing angle



7. LCM INTERFACE DESCRIPTION

Interface NO.	PIN NAME	I/O	DESCRIPTION
1	N/C	Float	No connection, Please float it
2-3	VDD	P	Power supply for digital
4	NC	I	No connected.
5	REST	I	Global reset pin. Active Low. Normally pull high.
6	STBYB	I	Display on/off switch, "H" display off
7	GND	P	Ground
8	RXIN0-	I/O	LVDS data lane 0-
9	RXIN0+	I/O	LVDS data lane 0+
10	GND	P	Ground
11	RXIN1-	I/O	LVDS data lane 1-
12	RXIN1+	I/O	LVDS data lane 1+
13	GND	P	Ground
14	RXIN2-	I/O	LVDS data lane 2-
15	RXIN2+	I/O	LVDS data lane 2+
16	GND	P	Ground
17	RXCLKIN-	I/O	LVDS clk lane -
18	RXCLKIN+	I/O	LVDS clk lane +
19	GND	P	Ground
20	RXIN3-	I/O	LVDS data lane 3-
21	RXIN3+	I/O	LVDS data lane 3+
22	GND	P	Ground
23	N/C	Float	No connection, Please float it
24	BIST		Normal Operation/BIST pattern select. Normally pull low BIST = H : BIST(DCLK input is not needed) BIST = L : Normal Operation
25	IFSEL		IFSEL = L : TTL interface IFSEL = H : LVDS interface
26	NC	/	No connection, Please float it
27	GND	P	Ground
28	NC	/	No connection, Please float it
29	L/R	I	L/R="L" Scan direction from right to left; L/R="H" Scan direction from left to right;
30	U/D	I	U/D="L" Scan direction from down to up; U/D="H" Scan direction from up to down;
31	NC	Float	No connection, Please float it
32-33	LEDK	P	LED Cathode for BL
34	NC	Float	No connection, Please float it
35-36	LEDA	P	LED ANODE for BL
37	XR/NC	Float	No connection, Please float it
38	YD/NC	Float	No connection, Please float it
39	XL/NC	Float	No connection, Please float it
40	YU/NC	Float	No connection, Please float it

8. AC CHARACTERISTICS

LVDS DC characteristic

Parameter	Symbol	Min.	Typ.	Max.	Unit	Condition
Differential input high threshold voltage	R _{xVTH}			+0.1V	V	R _{xVCM} =1.2V
Differential input low threshold voltage	R _{xVTL}	-0.1			V	
Input voltage range(single-end)	R _{xVN}	0		2.4	V	
Differential input common mode voltage	R _{xVCM}	V _{ID} /2		2.4 - V _{ID} /2	V	
Differential input voltage	V _{ID}	0.2		0.6	V	
Differential input leakage current	R _{xVTH}					
LVDS Digital Operating Current	I _{ddlvsd}	-	40(TBD)	50	mA	Fclk=65Mhz, VDD=3.3V
LVDS Digital Standby Current	I _{stlvsd}	-	10(TBD)	50	uA	Clock & all functions are stop

Single-End Signal

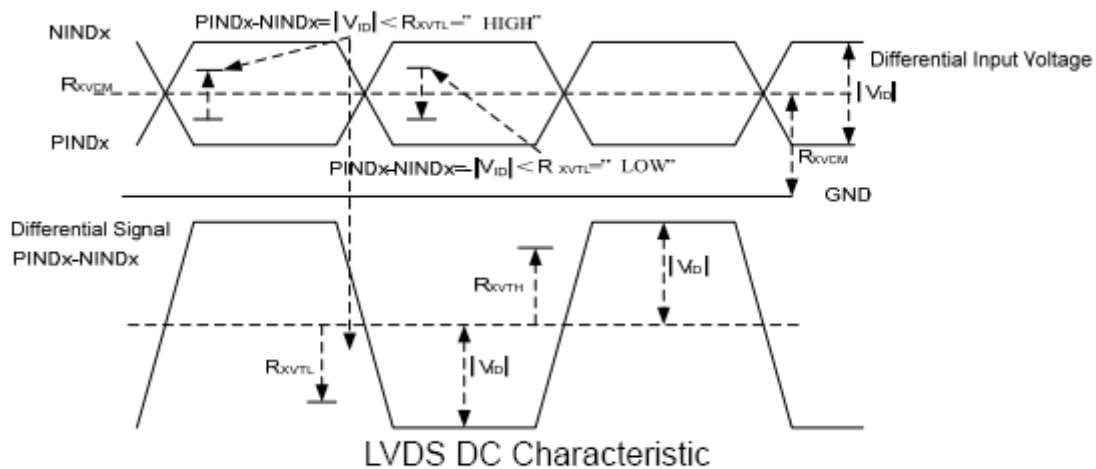

Parameter	Symbol	Condition	Min.	Typ.	Max.	Unit
Clock Frequency	R _{xFLCK}		20	-	71	MHz
Input data skew margin	TRSKM	V _{ID} =400mV R _{xVCM} =1.2V R _{xFLCK} =71MHz	500			ps
Clock High Time	TLVCH			4/(7* R _{xFLCK})		ns
						ns
Clock Low Time	TLVCL			3/(7* R _{xFLCK})		ns
PLL wake-up-time	T _{enPLL}				150	us

RGB CHARACTERISTICS

DE mode

DE mode					
Parameter	Symbol	Value			Unit
		Min.	Typ.	Max.	
DCLK frequency @Frame rate=60hz	fclk	40.8	51.2	67.2	Mhz
Horizontal display area	thd	1024			DCLK
HSYNC period time	th	1114	1344	1400	DCLK
HSYNC blanking	thb+thfp	90	320	376	DCLK
Vertical display area	tvd	600			H
VSYNC period time	tv	610	635	800	H
VSYNC blanking	tvb+tvfp	10	35	200	H

HV mode(1)

HV mode					
Horizontal input timing					
Parameter	Symbol	Value			Unit
		Min.	Typ.	Max.	
Horizontal display area	thd	1024			DCLK
DCLK frequency@ Frame rate=60hz	fclk	Min.	Typ.	Max.	Mhz
		44.9	51.2	63	
1 Horizontal Line	th	1200	1344	1400	DCLK
HSYNC pulse width	thpw	Min.	1		
		Typ.	-		
		Max.	140		
HSYNC back porch	thbp	160	160	160	
HSYNC front porch	thfp	16	160	216	

HV mode(2)

Vertical input timing					
Parameter	Symbol	Value			Unit
		Min.	Typ.	Max.	
Vertical display area	tvd	600			H
VSYNC period time	tv	624	635	750	H
VSYNC pulse width	tvpw	1	-	20	H
VSYNC back porch	tvb	23	23	23	H
VSYNC front porch	tvfp	1	12	127	H

Data Input Format for LVDS
6-bit LVDS input(HSD="H")

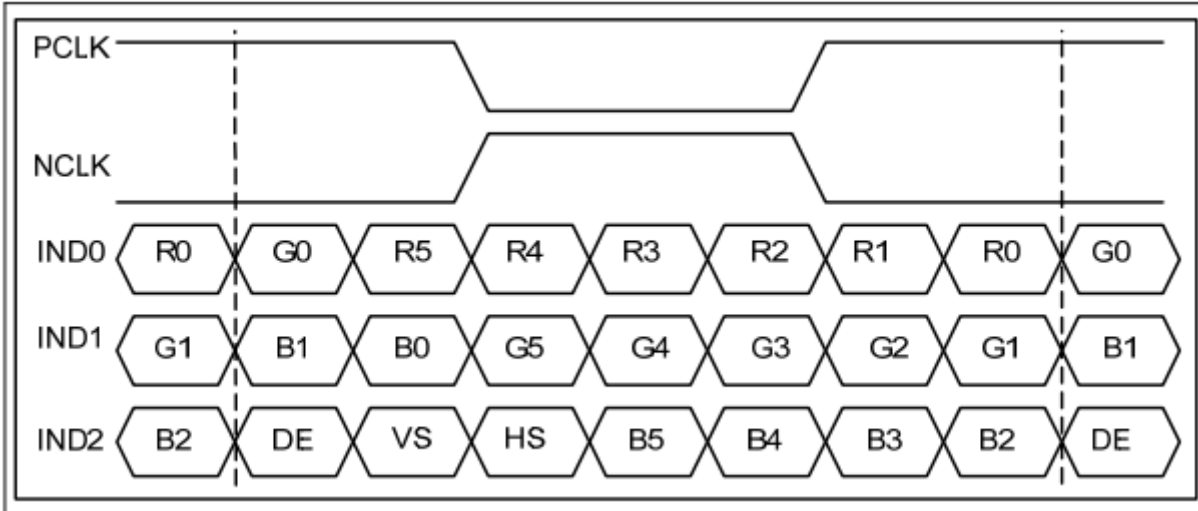

6-bit LVDS Input Timing chart

8-bit LVDS input(HSD="L")

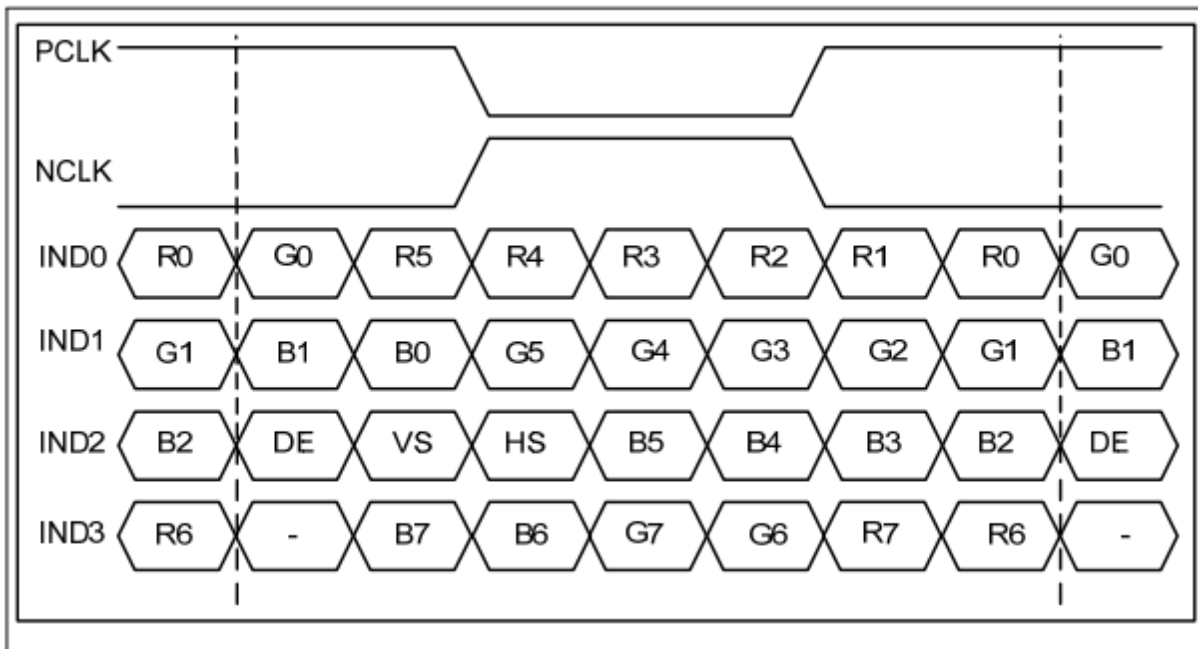

8-bit LVDS Input Timing chart

Data Input Format for TTL

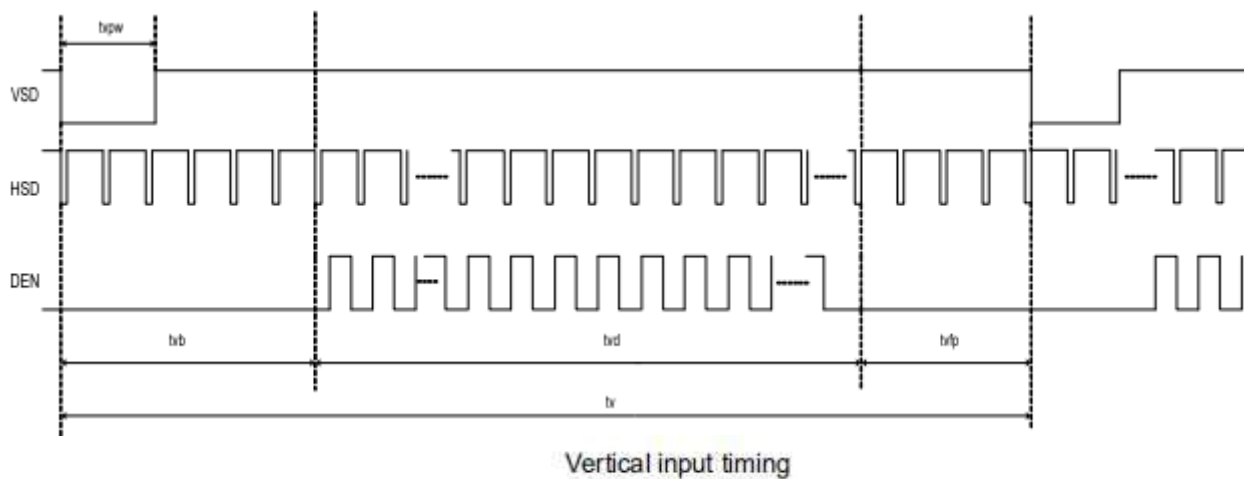

Vertical input timing

Horizontal input timing

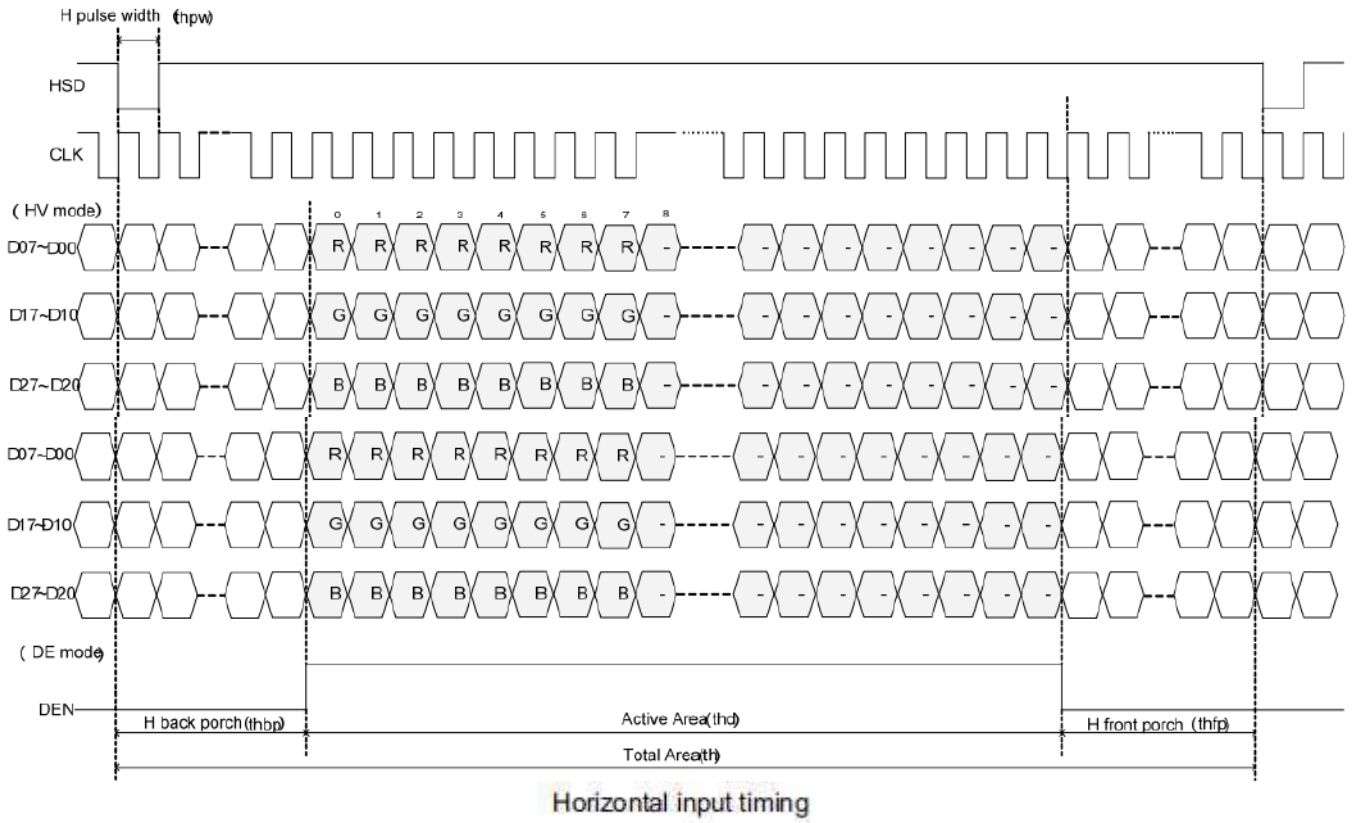

9. POWER SEQUENCE

9.1. Power On/Off Sequence

In order to prevent IC from power on reset fail, the rising time (TPOR) of the digital power supply VDD should be maintained within the given specifications. Refer to “AC Characteristics” for more detail on timing.

9.2. Power-On/Off Timing Sequence

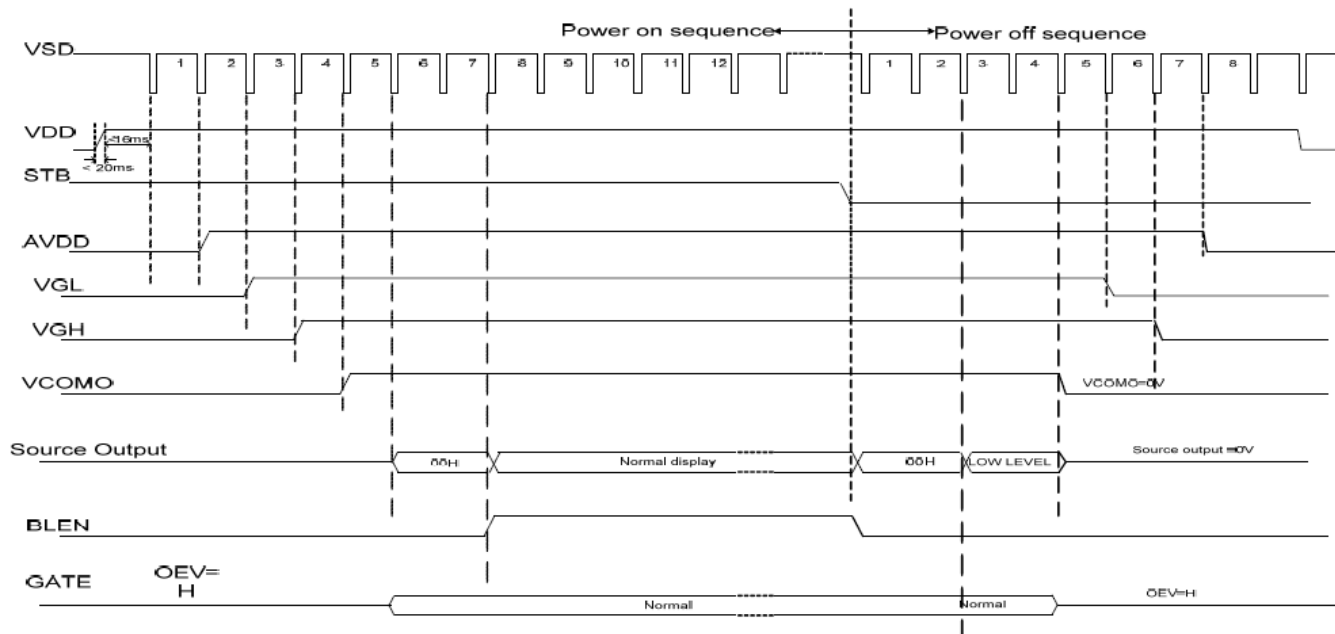

Power On/Off timing chart

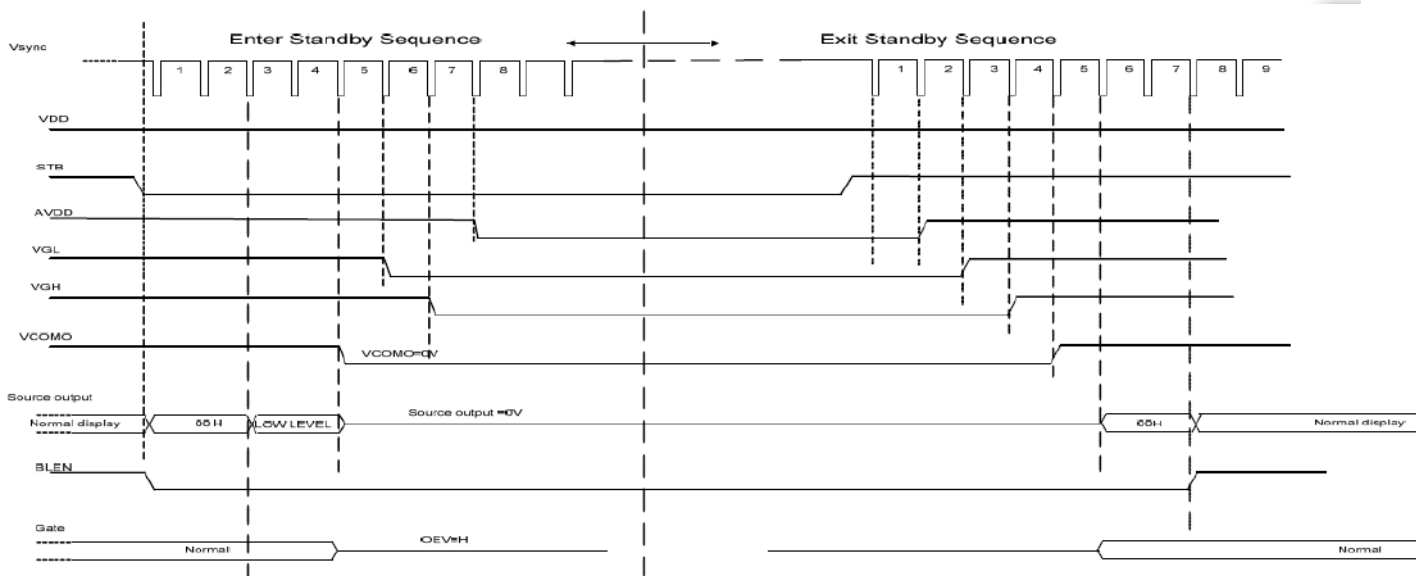

Enter and Exit Standby Mode timing chart

10. RELIABILITY TEST CONDITIONS

No.	Test Item	Test Condition	Inspection after test
1	High Temperature Storage	+80C/240 hours	Inspection after 2~4hours storage at room temperature, the sample shall be free from defects: 1.Current changing value before test and after test is 50% larger: 2. function defect:Non-display ,abn ormal-display,missing lines,Short lines, ITO corossion; 3.visual defect:Air bubble in the LCD,Sealleak,Glass crack。
2	Low Temperature Storage	-30°C/240 hours	
3	High Temperature Operating	+70°C/120 hours	
4	Low Temperature Operating	-20°C/120 hours	
5	Temperature Cycle	-30°C ~ 25°C ~ +80°C/10cycles (30min.) (10min.) (30min.)	
6	Damp Proof Test	50°C*90% RH/120 hours	
7	Vibration Test	Frequency: 10Hz~55Hz~10Hz Amplitude: 1.5mm, X, Y, Z direction for total 3hours (Packing condition)	
8	Dropping test	Drop to the ground from 1m height, one time, every side of carton. (Packing condition)	
9	ESD test	Voltage:±8KV R: 330Ω C: 150pF Air discharge, 10times	

Remark:

- 1.The test samples should be applied to only one test item.
- 2.Sample size for each test item is 3~5pcs.
- 3.For Damp Proof Test, Pure water(Resistance>10MΩ) should be used.
- 4.In case of malfunction defect caused by ESD damage, if it would be recovered to normal state after resetting, it would be judged as a good part.
- 5.EL evaluation should be excepted from reliability test with humidity and temperature: Some defects such as black spot/blemish can happen by natural chemical reaction with humidity and Fluorescence EL has.
- 6.Failure Judgment Criterion: Basic Specification, Electrical Characteristic, Mechanical Characteristic, Optical Characteristic.
- 7.The finished surface should be free of Drips,Globs,Glue and contamination.
- 8.The paint must adhere to the cover lens and withstand the following test:
 Pressure sensitive tape(SCOTCH #610 or equivalent adhesion strength) is applied to the painted surface
 And then rapidly removed by pulling at a 90 degree angle to the surface; There should be no evidence of
 paint seriating from the glass.

11. INSPECTION CRITERION

11.1 Objective

The CTP test criterion are set to formalize CTP quality standards for ODNA with reference to those of the customer for inspection, release and acceptance of finished CTP products in order to guarantee the quality of CTP products required by the customer.

11.2 Scope

This specification is applicable to capacitive touch panel manufactured by ODNA.

11.3 Equipment for Inspection

lamp-box、ionizing fan、10X microscopes、film card、alcohol/oil ether/acetone、finger cots、vernier caliper、anti-static wrist straps、microcalliper、feeler、pencil hardness tester、spectrophotometer、drop ball test,etc.

11.4 Sampling Plan and Reference Standards

11.4.1.1 Sampling plan:

Refer to National Standard GB/T 2828.1---2012/ISO2859-1:1999, level II of normal levels:

Major defect: AQL 0.4

Minor defect: AQL 1.0

11.5 Inspection Conditions and Inspection Reference

11.5.1 Inspection environment: temperature: $23\pm 3^{\circ}\text{C}$; humidity: 45~75%RH; cleanness: 10000 grade;

11.5.2 Inspection distance: $30\text{cm}\pm 5\text{cm}$;

11.5.3 Inspection angle: vertical rotate angle: $\pm 30^{\circ}$, up->down;horizontal rotate angle: $\pm 30^{\circ}$,left->right

11.5.4 Inspection luminance : fluorescent (finished product) inspection luminance is 800~1200Lux;

11.5.5 Background color: black/white;

11.5.6 Inspection time : 10~15s/ pcs

Black Booth or Black Background

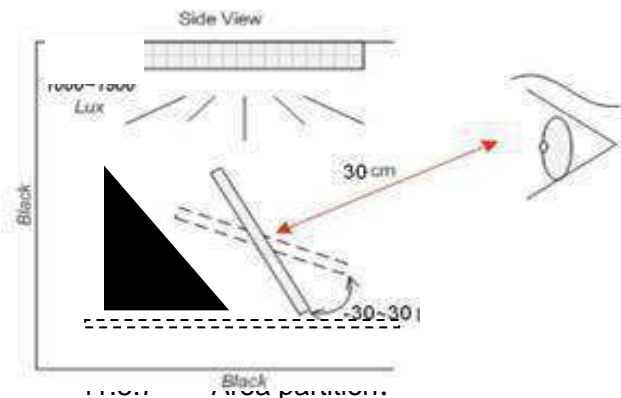

11.5.7.1 A area: front side visible area - BM(Black Mask), the area encircled by blue lines.



11.5.7.2 B area: four broadside(inspect from broadside) area & FPC area,encircled by green lines.

11.5.8 Defect type:

11.5.8.1 A area defect type:

Line defect (scratch、soft flocks、fibre)、dot defect (white dot、black dot、same color dot、different color dot、dust、bubble)、surface stain、pin-hole、light leak、scratch.

11.5.8.2 B area defect type:

Broken、crack/chipping、FPC defect

11.5.9 Undefined items or other special items, refer to mutual agreement and limited sample.If criterion does not match product specifications/ technical requirement, both should be subject to special inspection criterion agreed by customer.

11.6 Defects and Acceptance Standards

11.6.1 Electrical properties test

Check in ODNA tester.The program will release result automatically. There are “OK”、“PASS”、“NG”and the final judgment must be“OK”“PASS”,and we need to pass the draw line test.

Refer to 《**serise IC test program》

No.	Defects	Descriptions	Accepted standard	MAJ.	MIN.
11.6.1.1	Short	Measured data has much difference compared with normal;line is not stable	Reject	√	
11.6.1.2	Open	Measured data has no change.Line is open	Reject	√	
11.6.1.3	No reaction	No reaction and there is no line in screen	Reject	√	
11.6.1.4	Mis-display/ abnormal display	Screen has display but line is open or bent	Reject	√	
11.6.1.5	Button no reaction	Press the button but no reaction	Reject	√	
11.6.1.6	Button not correct	Press the button .Reaction is not stable	Reject	√	



11.6.2 Appearance inspection

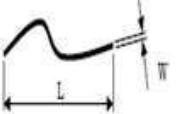

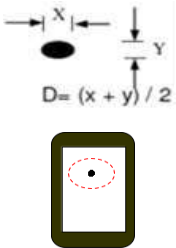
11.6.2.1 Dot/line defect

Defect	≧5”	5~10”	10~15”	>15”	Accepted standard	MAJ.	MIN.
S/C , line defect W:width L:length 	Tactile S/C->NG	Tactile S/C->NG	Tactile S/C->NG	Tactile S/C->NG	Reject		√
	W≤0.03mm, ->OK; Density is high ->NG	W≤0.05mm, ->OK; Density is high ->NG	W≤0.05mm, ->OK; Density is high ->NG	W≤0.05m m, ->OK; Density is high ->NG	Accept		√
	0.03mm< W≤0.10mm, L≤5mm quantity≤4 distance> 10mm	0.05mm< W≤0.1mm, L≤8mm quantity≤6 distance> 10mm	0.05mm< W≤0.1mm, L≤10mm quantity≤6 distance> 10mm	0.05mm< W≤0.1mm, L≤20mm quantity≤8 distance> 10mm	Accept		√
	W>0.10mm L>5mm	W>0.1mm L>8mm	W>0.1mm L>10mm	W>0.1mm L>20mm	Reject		√

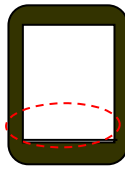
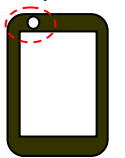
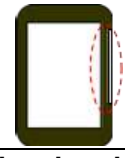
Dot defect D: Diameter 	$W \leq 0.10\text{mm}$, ->OK;	$W \leq 0.15\text{mm}$, ->OK;	$W \leq 0.15\text{mm}$, ->OK;	$W \leq 0.15\text{mm}$, ->OK;	Accept		√
	$0.10\text{mm} < D \leq 0.25\text{mm}$ quantity ≤ 4 distance $> 10\text{mm}$	$0.15\text{mm} < D \leq 0.30\text{mm}$ quantity ≤ 6 distance $> 10\text{mm}$	$0.15\text{mm} < D \leq 0.40\text{mm}$ quantity ≤ 6 distance $> 10\text{mm}$	$0.20\text{mm} < D \leq 0.50\text{mm}$ quantity ≤ 5 distance $> 10\text{mm}$	Accept		√
	$D > 0.25\text{mm}$	$D > 0.30\text{mm}$	$D > 0.40\text{mm}$	$D > 0.50\text{mm}$	Reject		√

11.6.2.2 LENS defect



Defect	Description	Accepted standard	MAJ.	MIN.
Printing zigzag 	zigzag width which is almost the same with VA area $W \leq 0.15\text{mm}$	Accept		√
	zigzag width which is almost the same with VA area $W > 0.15\text{mm}$	Reject		√
Wire mark 	$\leq 0.15\text{mm}$	Accept		√
	$> 0.15\text{mm}$	Reject		√
Ink pinhole 	Invisible with reflector light	Accept		√
Ink film defect	Ink film:s/c、 soft flocks、 fibre Ink film stain/color shift:refer to limited sample Ink film foreign material/scratch: refer to 6.2.1 visible area judgment	Accept		√
Ink light leak 	Broadside light leak width $\leq 0.15\text{mm}$ Each side light leak quantity ≤ 1	Accept		√
Ink color shift	Refer to limited sample			√
font、glass silver line (ink area) width $\geq 0.2\text{mm}$ 	$D \leq 0.20\text{mm}$; $N \leq 2$ ↑	Accept		√
	$D > 0.20\text{mm}$	Reject		√
	Refer to limited sample, if it's out of spec	Reject		√

word/color error	Word or color or position is different from drawing and sample.	Reject	√	
word missing width≤0.2mm 	height, $a \leq 1/4h$, $width \leq 1/2w$	Accept		√
Font thickness different and color nonuniform 	Refer to limited sample, if it's out of spec	Reject		√
IR/video/ Receive hole /Button hole	Irregular hole , offside, refer to drawing	Accept		√
	Foreign material/scratch exist in hole, refer to 6.2.1	Reject		√
LENS broadside foreign material	Width $\leq 0.15mm$	Accept		√
Ink spill	LENS broadside or receive hole or button hole have ink spill defect, refer to limited sample.	Accept		√

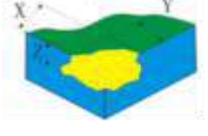
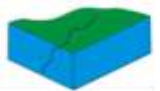
11.6.2.3 Breakage

Defect	$\leq 5''$	5~10''	10~15''	>15''	Accepted standard	MAJ.	MIN.
LENS breakage 	$X \leq 0.3mm$, $Y \leq 0.3mm$, one side ≤ 1	$X \leq 0.3mm$, $Y \leq 0.4mm$, one side ≤ 1	$X \leq 0.4mm$, $Y \leq 0.4mm$, one side ≤ 1	$X \leq 0.5mm$, $Y \leq 0.5mm$, one side ≤ 1	Accept		√
	$X > 0.3mm$, $Y > 0.3mm$	$X > 0.3mm$, $Y > 0.4mm$	$X > 0.4mm$, $Y > 0.4mm$	$X > 0.5mm$, $Y > 0.5mm$	Reject		√
Sensor breakage	Not affect ITO line, not lengthen, function test is OK And be non-visual after attaching Lens				Accept		√
	affect ITO line and be visual				Reject		√
Glass crack 	Crack lengthen to outside				Accept		√
	Crack lengthen to inside				Reject		√

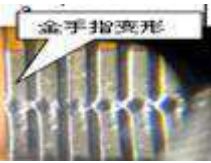
11.6.2.4 FPC defect

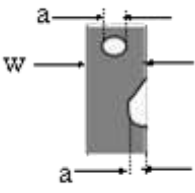
Defect	Description	Accepted standard	MAJ.	MIN.
FPC folding 	FPC is folding and can not restore-> Reject FPC is folding and can restore->compare with limited sample	Reject		√
FPC cover layer defect	FPC cover layer peeling off	Reject		√
FPC color shift and bubble	PI layer have color shift or bubbled due to high welding temperature or long welding time.	Reject		√
Golden finger defect 	peeling off、bonding deformed、glue remained、oxidized, stained	Reject		√
Joggle defect 	bent, broken, peeling off	Reject		√
FPC defect 	(golden finger) dented, pin hole $a \leq w/3$	Accept		√
	open/scratch/cracked	Reject		√
	oxidized, stained	Reject		√
FPC loophole	Soft loopholes $\leq 2.0\text{mm}$, hard (PCB、PC、steel cover layer) loopholes $\leq 1.0\text{mm}$	Accept		√

11.6.2.5 Attaching defect (protective film/adhesive tape/foam/PC...)

Defect	Description	Accepted standard	MAJ.	MIN.
High temperature glue paper	1.Glue paper attached in FPC doesn't cover component or FPC cove layer. 2.Glue paper attached in golden finger doesn't cover golden finger or peel off	Reject		√
Protective film	Clean、 attaching flat、 no shifting or bubble	Accept		√
	Protective film attaching bubble in VA: $D \leq 2.0\text{mm}$ $N \leq 5$ distance $\leq 20\text{mm}$	Accept		√
	Protective film attaching bubble in VA: $D > 2.0\text{mm}$ $N > 5$ distance $> 20\text{mm}$	Reject		√

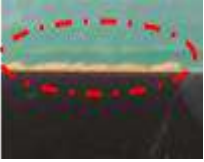
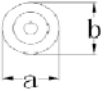
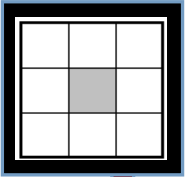

Tape	Attach position refer to the drawing	Accept		√
Foam	Gap spec:0.5+/-0.5mm, foam must be smaller than sensor edge side and can not enter into VA.	Accept		√
PC board/ adhesive tape	Tape must be smaller than LENS edge side and can not be folding ,dent or shifting.	Accept		√
Anti-explosion fim/Anti-glare film/blue film	Impression print refer to the limited sample	Accept		√
	Attach position refer to the drawing	Accept		√

11.6.2.6 Others

Defect	Description	Accepted standard	MAJ.	MIN.
Glue flow 	Insulation oil flow in VA area	Reject		√
	ACF/insulation oil flow in VA area	Reject		√
	Sensor edge side glue flow	Accept		√
IC/FPC gap glue	FPC gap glue:cover FPC connect point totally IC glue: cover IC line connect totally	Accept		√
	Glue height : follow the technology spec	Accept		√
Newton circles (rainbow) 	Circles quantity> 2	Reject		√
Layering	LENS/Sensor layering	Reject	√	
Surface	Stain defect which can be removed by cleaning solvent and cloth Defect quantity≤10% Lot total quantity->Accept Remark: defect product which is sorted out by AQL is not included in the 10% part.Unmovable stain refer to 6.2.1 specification.	Reject		√
Isolation point  VA diagram	Gray area In 8X8mm area, all isolation points are missing	Reject		√
	White area In 15X15mm area,all isolation points are missing	Reject		√
	5mm within VA (black area) , isolation points missing ->Ignored	Accept		√
	Isolation points are overlaid	Accept		√

11.6.3 TFT defects and Inspection Criterion

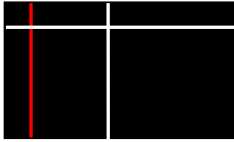
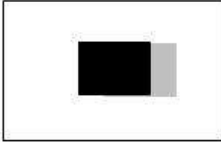
11.6.3.1 Function items(Defect category MA)

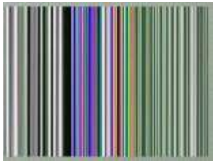
Defects	Inspection Criterion	Pictures	Inspection method/tools	Defect category
No display /reaction	shows no picture/display in normal connected situation. ->Rejected		Naked eyes/ testers	MA
Missing segment	Shows missing lines in normal display		Naked eyes/ testers	MA
Image retention (sticking)	The previous picture stays in the next picture.Disappear time <10s, OK; time>10s, NG		Naked eyes/ testers	MA
Flicker	Not accepted		Naked eyes/ testers	MA
Display abnormal	Not accepted		Naked eyes/ testers	MA
Display dim/bright	Refer to limited sample	/	Naked eyes/ limited sample	MA
Contrast	Refer to limited sample	/	Naked eyes/ limited sample	MA
White dot	Refer to dot criterion	/	Naked eyes	MI
White speckle	Refer to limited sample	/	Naked eyes/ limited sample	MI
Yellow speckle	Refer to limited sample	/	Naked eyes/ limited sample	MI

11.6.3.2 LCD pixel dot defect(defect category: MI)

Item	Inspection criterion			
	S <5"	5≤S<10"	10≤S<15"	>15"
Color pixel dot defect(RGB dot)	1	2	2	3
2 connected bright dot	0	0	1	1
3 connected bright dot or more	0	0	0	0
Bright dot quantity	1	2	3	4
Random dark dot quantity	2	3	4	5
2 connected dark dot	1	1	2	2

Item	Inspection criterion			
3 connected dark dot or more	0	0	0	0
Dark dot quantity	3	4	5	6
Multi-bright dot	ND 5% hidden, OK			
Remark: 2 bright dots distance DS≥15mm 2 dark dots distance DS≥5mm				
1) Bright dot: Power on TFT and RGB dot in black display				
2) Dark dot: Power on TFT and gray or black dot in RGB display				
3) Multi-bright dot: Power on TFT and fluorescent tiny dot in black display(only visible in black display)				

11.6.3.3 Backlight components

No.	Item	Description	Accepted criterion	MAJ.	MIN.
11.6.3.3.1	No backlight wrong Color	/	Rejected	√	
11.6.3.3.2	Color deviation	When powered on, the LCD color differs from its sample and found that the color not conforming to the drawing after testing.	Refer to sample and drawing.		√
11.6.3.3.3	Brightness deviation	When powered on, the LCD brightness differs from its sample and is found after testing not conforming to the drawing; or if it conforms to the drawing but the brightness over ±40% than its typical value.	Refer to sample and drawing.		√
11.6.3.3.4	Uneven brightness	Uneven on the same LCD and out of the specification of the drawing. The no specification evenness= (the max value-the min value)/ mean value< 70%.	Refer to sample and drawing.		√
11.6.3.3.5	Spot/line /scratch	When power on, it has dirty spot, scratches and so on spot and line defects.	Refer to 6.2.1		√

11.6.3.4 Metal frame (Metal Bezel)

No.	Item	Description	Accepted criterion	MAJ.	MIN.
11.6.3.4.1	Material & surface treatment	Metal frame/surface treatment do not conform to the specifications.	Rejected	√	
11.6.3.4.2	Tab twist Unconformity/ Tab not twisted	Wrong twist method or direction and twist tabs are not twisted as required.	Rejected	√	
11.6.3.4.3	Bezel paint loss	Scratch/paint loss/Bezel surface concave-convex dot/dent	1.Front surface: Paint peel off and scratch to the bottom Dot:D≤0.5mm, exceeds 3; Line:L≤3.0mm,W≤0.05mm exceeds 2; 2.Front dent, air bubble and side with paint peeling off scratch to the bottom Dot: D≤1.0mm, exceeds 3; Line:L≤3.0mm,W≤0.05mm, exceeds 2;	√	
11.6.3.4.4	Bezel scratch			√	
11.6.3.4.5	Painting peel off, discoloration,dent, and scratch			√	
11.6.3.4.6	Burr	Burr(s) on metal bezel is so long as to get into viewing area.	Rejected	√	

11.6.3.5 Others

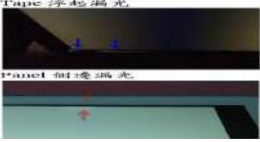
No.	Item	Description	Accepted criterion	MAJ.	MIN.
11.6.3.5.1	Assembly foreign material	Dot/linear stain after assembly backlight and diffuse film TP assembly foggy stain	Invisible when power on->OK Refer to 6.2.1 dot/line spec		√
11.6.3.5.2	Product mark	Missing, unclear, incorrect, or misplaced part	Rejected		√
11.6.3.5.3	Newton's rings	Area<1/6 screen area quantity≤1	Accepted		√
11.6.3.5.4	Mura	1.In black display ND 5% invisible ->OK; visible->NG 2.Naked eyes inspection RGB display invisible Black display, area<1/4 screen area	Refer to limited sample 		√
11.6.3.5.5	Light leak	1.LCD edge (near backlight) shadow by LCD lamps irregular illuminate 2.Judge in black/white/gray display (slight leaky is yellowish,greenish, blueish ->NG) ; 	Refer to limited sample		√
11.6.3.5.6	Polarizer	1.Polarizer slant.Cover VA and not over LCD edge 2.No unmovable stain or finger print in polarizer VA 3.Bubble/warped but not enter VA	Accepted		√

11.6.4 General Appearance

11.6.4.1 Common function inspection equipment :micro calliper、vernier caliper、pencil hardness tester、spectrophotometer 、drop ball test.

No.	Items	Spec
1	Dimension	According to drawing
2	Curl	≤0.3% -> OK, "S" curl ->NG
3	Surface hardness	According to drawing
4	VA TT (550nm)	According to drawing
5	IR TT-- (550nm & 850nm)	According to drawing
6	Intensity (drop ball test)	According to drawing

Remark: the criterion is common for all product and if some components are not included,just ignore it.

12. HANDLING PRECAUTIONS

12.1 Mounting method

The LCD module consists of two thin glass plates with polarizers which easily be damaged. And since the module is so constructed as to be fixed by utilizing fitting holes in the printed circuit board. Extreme care should be needed when handling the LCD modules.

12.2 Caution of LCD handling and cleaning

When cleaning the display surface, Use soft cloth with solvent

[recommended below] and wipe lightly

- .Isopropyl alcohol
- .Ethyl alcohol

Do not wipe the display surface with dry or hard materials that will damage the polarizer surface.

Do not use the following solvent:

- .Water
- .Aromatics

Do not wipe ITO pad area with the dry or hard materials that will damage the ITO patterns

Do not use the following solvent on the pad or prevent it from being contaminated:

- .Soldering flux
- .Chlorine (Cl) , Sulfur (S)

If goods were sent without being silicon coated on the pad, ITO patterns could be damaged due to the corrosion as time goes on.

If ITO corrosion happens by miss-handling or using some materials such as Chlorine (Cl), Sulfur (S) from customer, Responsibility is on customer.

12.3 Caution against static charge

The LCD module use C-MOS LSI drivers, so we recommended that you:

Connect any unused input terminal to Vdd or Vss, do not input any signals before power is turned on, and ground your body, work/assembly areas, assembly equipment to protect against static electricity.

12.4 Packing

Module employ LCD elements and must be treated as such.

- .Avoid intense shock and falls from a height.
- .To prevent modules from degradation, do not operate or store them exposed direct to sunshine or high temperature/humidity

13.5 Caution for operation

- .It is an indispensable condition to drive LCD's within the specified voltage limit since the higher voltage than the limit cause the shorter LCD life.
- .An electrochemical reaction due to direct current causes LCD's undesirable deterioration, so that the use of direct current drive should be avoided.
- .Response time will be extremely delayed at lower temperature than the operating temperature range and on the other hand at higher temperature LCD's show dark color in them. However those phenomena do not mean malfunction or out of order with LCD's, which will come back in the specified operation temperature.
- .If the display area is pushed hard during operation, some font will be abnormally displayed but it resumes normal condition after turning off once.
- .A slight dew depositing on terminals is a cause for electro-chemical reaction resulting in terminal open circuit.

Usage under the maximum operating temperature, 50%Rh or less is required.

12.6 Storage

In the case of storing for a long period of time for instance, for years for the purpose or replacement use, the following ways are recommended.

- .Storing in an ambient temperature 10°C to 30°C, and in a relative humidity of 45% to 75%. Don't expose to sunlight or fluorescent light.
- .Storing in a polyethylene bag with the opening sealed so as not to enter fresh air outside in it . And with no desiccant.
- .Placing in a dark place where neither exposure to direct sunlight nor light's keeping the storage temperature range.
- .Storing with no touch on polarizer surface by anything else.

It is recommended to store them as they have been contained in the inner container at the time of delivery from us.

12.7 Safety

- .It is recommendable to crash damaged or unnecessary LCD's into pieces and wash off liquid crystal by either of solvents such as acetone and ethanol, which should be burned up later.
- .When any liquid leaked out of a damaged glass cell comes in contact with your hands, please wash it off well with soap and water

13. PRECAUTION FOR USE

14.1 A limit sample should be provided by the both parties on an occasion when the both parties agreed its necessity. Judgment by a limit sample shall take effect after the limit sample has been established and confirmed by the both parties.

13.2 On the following occasions, the handing of problem should be decided through discussion and agreement between responsible of the both parties.

- .When a question is arisen in this specification
- .When a new problem is arisen which is not specified in this specifications
- .When an inspection specifications change or operating condition change in customer is reported to ODNA, and some problem is arisen in this specification due to the change
- .When a new problem is arisen at the customer's operating set for sample evaluation in the customer site.

14. PACKING SPECIFICATION

Please consult our technical department for detail information.