



NOVATEK
聯詠科技

Data Sheet

NT39419B

1200CH TFT LCD Source Driver with TCON

V0.6

Preliminary Spec

Innolux only

Revise History

NT39419B Specification Revision History			
Version	Content	Page	Date
0.0	New Spec.	All	2008/05/15
0.1	1. Correct the default value of DCMP_EN	9	2008/06/25
0.2	1. Remove DBGATE. 2. Modify GAMMA table.	14 16~17	2008/06/25
0.3	1. Modify the default setting of DCMP_EN	9	2008/07/21
0.4	1. Correct the general description 2. Modify GAMMA table	4 16~17	2008/10/15
0.5	1. Correct theGamma table	16	2009/03/25
0.6	1. Modify 2-dot inversion → 1+2-dot inversion	9,11	2012/09/25

NOVATEK CONFIDENTIAL
NO DISCLOSURE

Index

REVISE HISTORY	2
INDEX	3
FEATURES	4
GENERAL DESCRIPTION.....	4
FUNCTION BLOCK DIAGRAM	5
APPLICATION BLOCK DIAGRAM – DUAL GATE APPLICATION.....	6
PAD SEQUENCE (BUMP SIDE)	7
PAD DESCRIPTION	8
FUNCTION DESCRIPTION	13
Power On/Off Sequence	13
Input Data VS Output Channels	14
Input Data VS Output Voltage	15
Input Data and Output Voltage Reference Table (VSET = “0”).....	16
DATA INPUT FORMAT.....	18
Vertical input timing	18
Horizontal input timing.....	18
TIMING CHARACTERISTIC	19
For 800x480 panel.....	19
For 800x600 panel.....	20
ABSOLUTE MAXIMUM RATINGS.....	21
VOLTAGE.....	21
TEMPERATURE.....	21
RECOMMENDED OPERATING RANGE	21
DC ELECTRICAL CHARACTERISTICS.....	22
AC ELECTRICAL CHARACTERISTICS.....	23
TIMING TABLE.....	23
Parallel 24-bit RGB Mode.....	23
TIMING DIAGRAM.....	24
Input Clock and Data Timing Diagram	24
Source Output.....	24
Vertical Timing Diagram (HV mode).....	24
Vertical Timing Diagram (DE mode).....	25
PAD OUTLINE DIMENSION 1 (BUMP SIDE).....	26
PAD OUTLINE DIMENSION 2 (BUMP SIDE).....	27
ALIGNMENT MARK.....	28
PAD INFORMATION	28
APPENDIX A: PAD COORDINATES.....	29
APPENDIX B: BIST PATTERN	44

Features

- Special design for small-sized color TFT LCD source drivers with timing controller
- Integrated 1200 channel source driver
- Support dual-gate operation mode
- Support display resolutions : 800(RGB)x480 、 800(RGB)x600
- Support TTL 24-bit parallel (RGB) input timing
- Source output with 8-bit resolution 256 gray scale (2-bit dithering)
- Support Delta or Stripe color filter configuration
- Support stand-by mode for low power consumption
- Pin controlled UP/DOWN, LEFT/RIGHT, HV/DE mode select function
- Embedded Gamma Table for special custom request
- Support external V1 ~ V14 pad for Gamma adjusting
- Output dynamic range: 0.1 ~ AVDD-0.1V
- Power for source driver voltage AVDD: 6.5V ~ 13.5V
- Power for digital interface circuit VDD: 3.0 ~ 3.6V
- Max. operating frequency: 50 MHz
- COG package

General Description

NT39419B is a highly integrated 1200 channel source driver with TTL interface Timing Controller for color TFT-LCD panels. NT39419B is special designed for dual-gate architecture TFT panel. This chip is dedicated for the display resolution of: 800*480 and 800*600 application.

NT39419B input timing support TTL digital 24bit parallel RGB data format, and source output support 8-bit resolution 256 gray scales with dithering feature enabled. Operating parameters can be set via pin control for all control features. Special circuit architecture is designed for lower power dissipation.

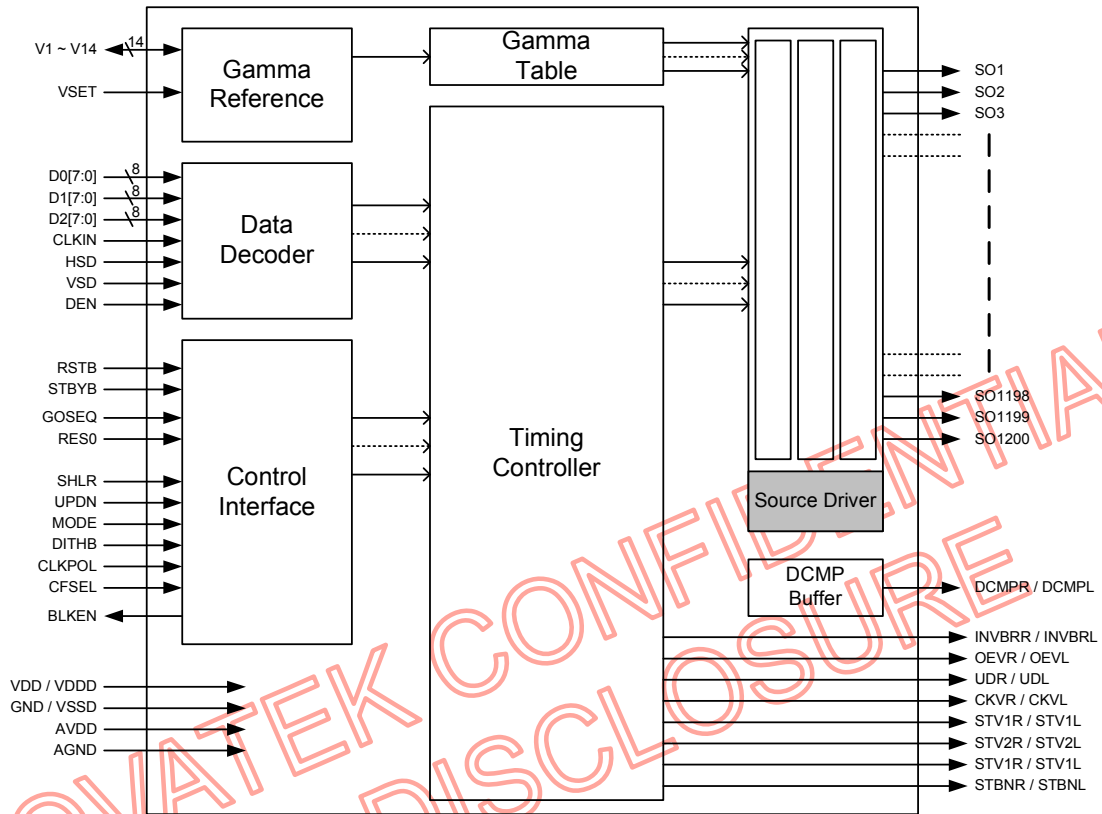
Function Block Diagram

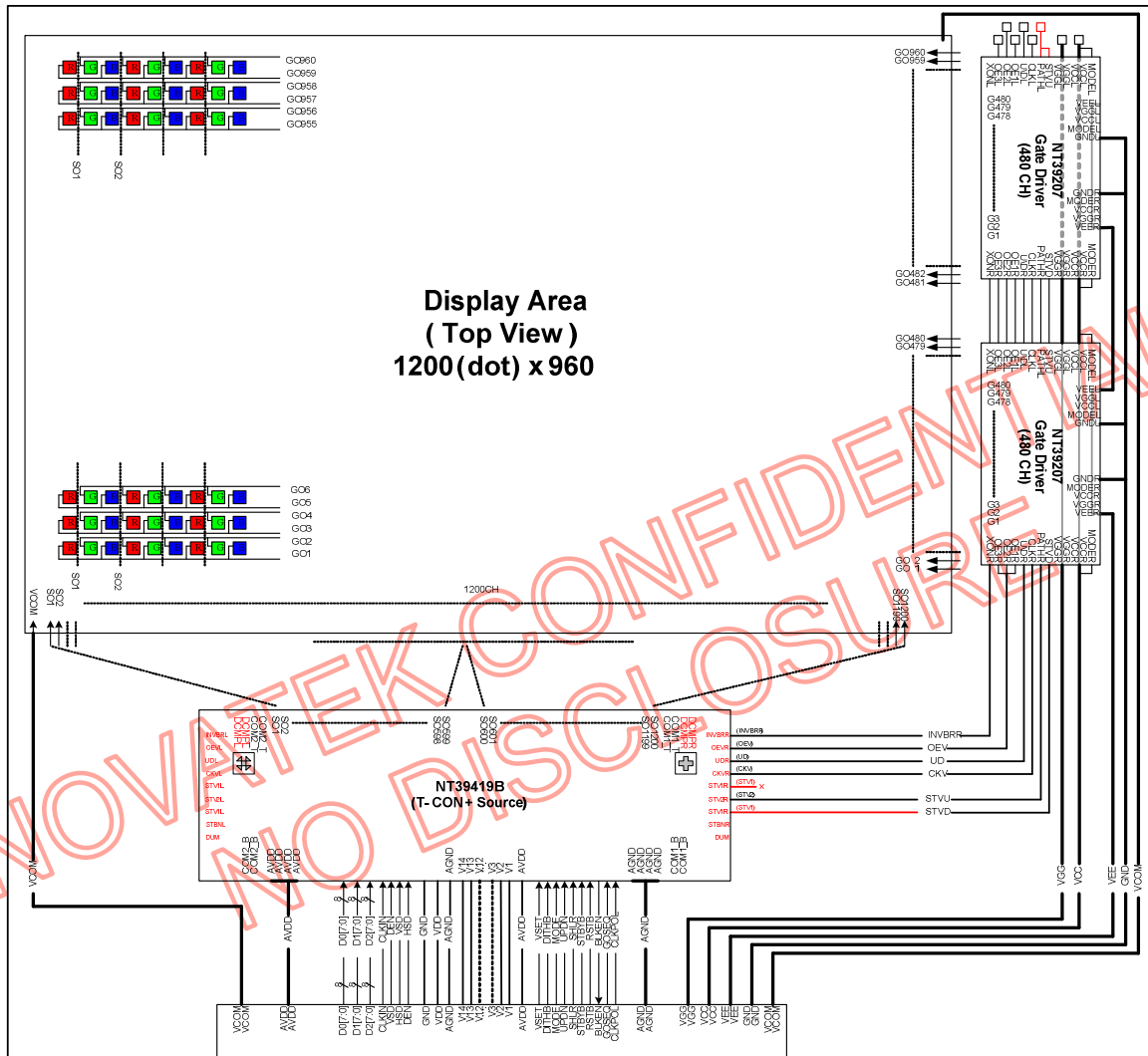
Application Block Diagram – Dual Gate Application

Pad Sequence (Bump Side)

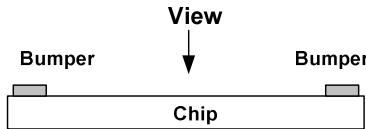

With respect to the information represented in this document, Novatek makes no warranty, expressed or implied, including the warranties of merchantability, fitness for a particular purpose, non-infringement, or assumes any legal liability or responsibility for the accuracy, completeness, or usefulness of any such information.

Pad Description

NT39419B Pad Description:

Designation	I/O	Description
D07~D00 D17~D10 D27~D20	I	Parallel data Input. For TTL 24-bit parallel RGB image data input. D[07:00] = R[7:0] data; D[17:10] = G[7:0] data; DIN[27:20] = B[7:0] data. For 18bit RGB interface, connect two LSB bits of all the R/G/B data buses to GND.
CLKIN	I	Clock for Input Data. Data latched at rising/falling edge of this signal. Default falling edge.
HSD	I	Horizontal Sync input. Negative polarity.
VSD	I	Vertical Sync input. Negative polarity.
DEN	I	Data Input Enable. Active High to enable the data input bus under "DE Mode". Normally pulled low.
MODE	I	DE / SYNC mode select. Normally pulled high H : DE mode. L : HSD/VSD mode.
RES0	I	Display resolution selection. Normally pulled low. RES0 = "0", for 800(RGB)*480 display resolution RES0 = "1", for 800(RGB)*600 display resolution
DITHB	I	Dithering function enable control. Normally pulled high DITHB = "1", Disable internal dithering function DITHB = "0", Enable internal dithering function
CLKPOL	I	Input clock edge selection. Normally pulled low CLKPOL = "1", Latch data at CLKIN rising edge. CLKPOL = "0", Latch data at CLKIN falling edge. (Default)
BLKEN	O	Backlight enable control signal for external controller. BLKEN = "1", Logical control signal to turn on external backlight controller BLKEN = "0", Turn off external backlight controller Note: Refer to the Power On/Off Sequence for the detail information.
CFSEL	I	Color Filter type selection. Normally pulled high CFSEL = "1", Stripe mode. (Default) CFSEL = "0", Delta mode
V1 ~ V14	I/O	When VSET="0", INTERNAL Gamma Table is used. V1~V14 pad are un-used. When VSET="1". V1~V14 are the external gamma correction points. The voltage of these pins must be: AGND<V14<V13<V12<V11<V10<V9<V8;V7<V6<V5<V4<V3<V2<V1< AVDD
VSET	I	When VSET="0", INTERNAL Gamma Table is used. V1~V14 pad are un-used. When VSET="1". V1~V14 are the external gamma correction points. Normally pulled low.
RSTB	I	Global reset pin. Active Low to enter Reset State. Suggest to connecting with an RC reset circuit for stability. Normally pulled high.

Designation	I/O	Description
STBYB	I	Standby mode, normally pulled high. STBYB = "1", normal operation STBYB = "0", timing controller, source driver will turn off, all output are High-Z
SHLR	I	Source Right or Left sequence control. Normally pulled high. SHLR = "L", shift left: last data = S1 ← S2 ← S3..... ← S1200 = first data. SHLR = "H", shift right: first data = S1 → S → S3..... → S1200 = last data.
UPDN	I	Gate Up or Down scan control. Normally pulled low. UPDN = "L", STV2 output vertical start pulse and UD pin output logical "0" to Gate driver. UPDN = "H", STV1 output vertical start pulse and UD pin output logical "1" to Gate driver.
BIST	I	Normal Operation/BIST pattern select. Normally pulled low BIST = H : BIST(DCLK input is not needed) BIST = L : Normal Operation
GOSEQ	I	Gate on sequence. Normally pulled low. Please refer to Note 1. GOSEQ = H : INVBRR/INVBRL = L Gate on G1 → G2 → G4 → G3 → G5 → G6 → G8 → G7..... GOSEQ = L : INVBRR/INVBRL = H Gate on G1 → G2 → G3 → G4 → G5 → G6 → G7 → G8.....
DCMP_EN	I	DCMP enable control signal. Normally pulled high. DCMP_EN=H, the DCMP signal is enable. DCMP_EN=L, the DCMP signal is disable.
TB0	I	One dot or Two dot inversion selection. Normally pulled low. Refer to Note 2. TB0 = H : one dot inversion. TB0 = L : 1+2-dot inversion. (default)
OEVR/OEVL	O	Gate driver control signal.
UDR/UDL	O	Gate driver control signal.
CKVR/CKVL	O	Gate driver control signal.
STV1R/STV1L	O	Gate driver control signal.
STV2R/STV2L	O	Gate driver control signal.
STBNR/STBNL	O	Gate driver control signal.
INVBRR/INVBRL	O	Gate driver control signal (For special Gate on sequence).
DCMPR/DCMPL	O	Data line compensation. When source output in positive polarity, DCMP output data 20H voltage level of negative polarity. When source output in negative polarity, DCMP output data 20H voltage level of positive polarity
AVDD	PI	Power supply for analog circuits
AGND	PI	Ground pins for analog circuits
VDD/VDDD	PI	Power supply for digital circuits
GND/VSSD	PI	Ground pins for digital circuits

Designation	I/O	Description
SO1~SO1200	O	Source Driver Output Signals. All outputs will be of unknown values under stand-by mode.
ALIGN	M	For assembly alignment.
COM1_B COM1_T	S	Internal link together between input side and output side.
COM2_B COM2_T	S	Internal link together between input side and output side.
TP14~0 TB4~1	T	Test pin for Novatek only. Float these pins for normal operation.
SHIELDING	SH	IC Shielding pads. Those pins are internally connected to the AGND. DO NOT connect to any WOA on the panel.
DASHD	SH	Data Bus Shielding pad. Those pins are internally connected to the GND. RECOMMAND to add shielding lines on the FPC to reduce EMI.
DUM	D	Dummy pads. Those pins are floating pads.

Note:

I: Input, O: Output, P: Power, D: Dummy, S: Shorted line, M: Mark, PI: Power input, PO: Power output,

T: Testing, SH: Shielding, I / O: Input / Output, PS: Power Setting, C: Capacitor pin.

Note 1 :

GOSEQ = L , INVBRRINVBRL= H ,
With traditional Gate driver.

GOSEQ = H , INVBRRINVBRL= L ,
With special design Gate driver

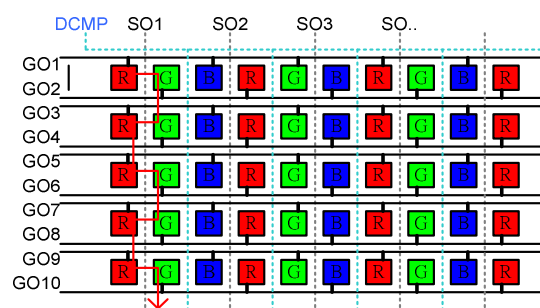
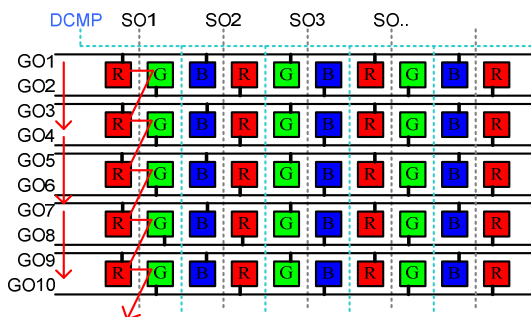

Note 2 :

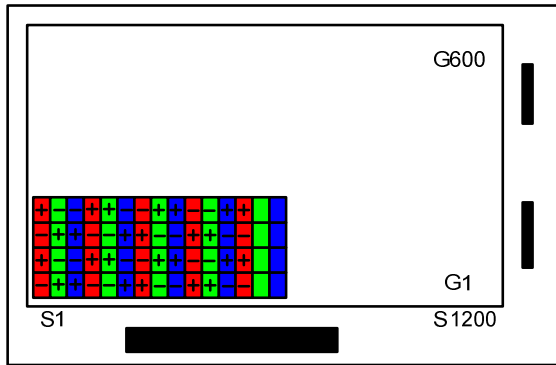

1+2-dot

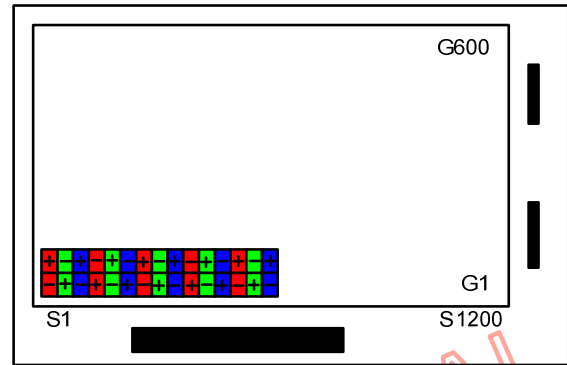

1-dot

NT39419B Pass Line Description:

Pass Line No:	Pad Name	
1	COM1_B	COM1_T
2	COM2_B	COM2_T

Value of wiring resistance to each pin

The recommended wiring resistance values are shown below. The wiring resistance values affect the current capacity of the power supply, so be sure to design using values that do not exceed those recommended.

Pin Name	Wiring resistance value(Ω)	Pin Name	Wiring resistance value(Ω)
AVDD	<5	OEVx	<500
AGND	<5	UDx	<500
VDD	<10	CKVx	<500
GND	<10	STV1x	<500
V1~V14	<10	STV2x	<500
D00~D07	<50	STBNx	<500
D10~D17	<50		
D20~D27	<50		
CLKIN	<50		
VSD	<50		
HSD	<50		
DEN	<50		
RSTB	<500		
STBYB	<500		
DITHB	<500		
SHLR	<500		
UPDN	<500		
BIST	<500		
MODE	<500		
RES0	<500		
CLKPOL	<500		
BLKEN	<500		
CFSEL	<500		
VSET	<500		

Function Description

Power On/Off Sequence

In order to prevent IC from power on reset fail, the rising time (T_{POR}) of the digital power supply VDD should be maintained within the given specifications. Refer to “AC Characteristics” for more detail on timing.

Power-On/Off Timing Sequence:

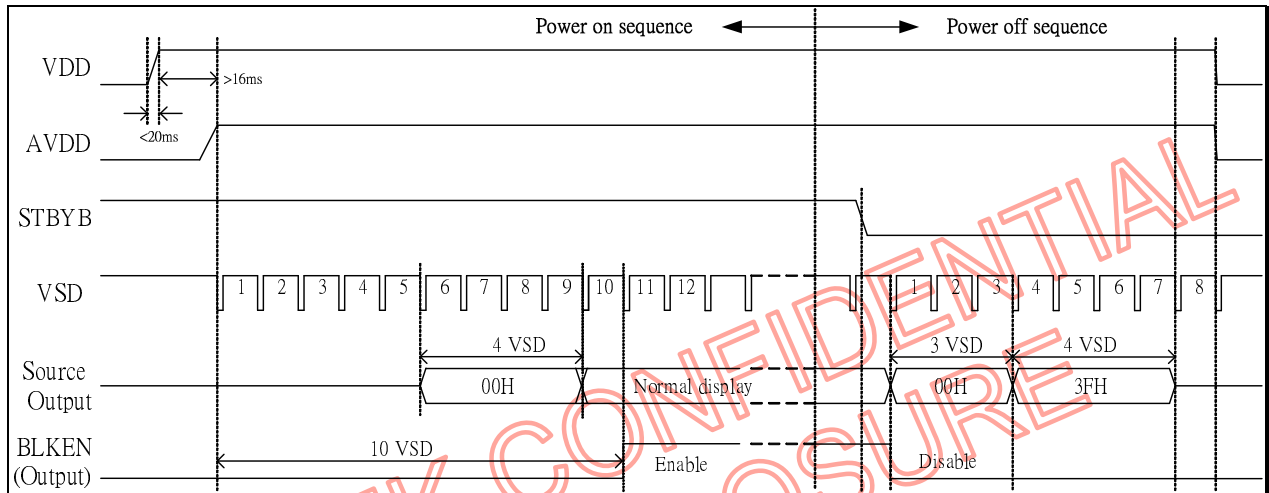

Enter and Exit Standby Mode Sequence:

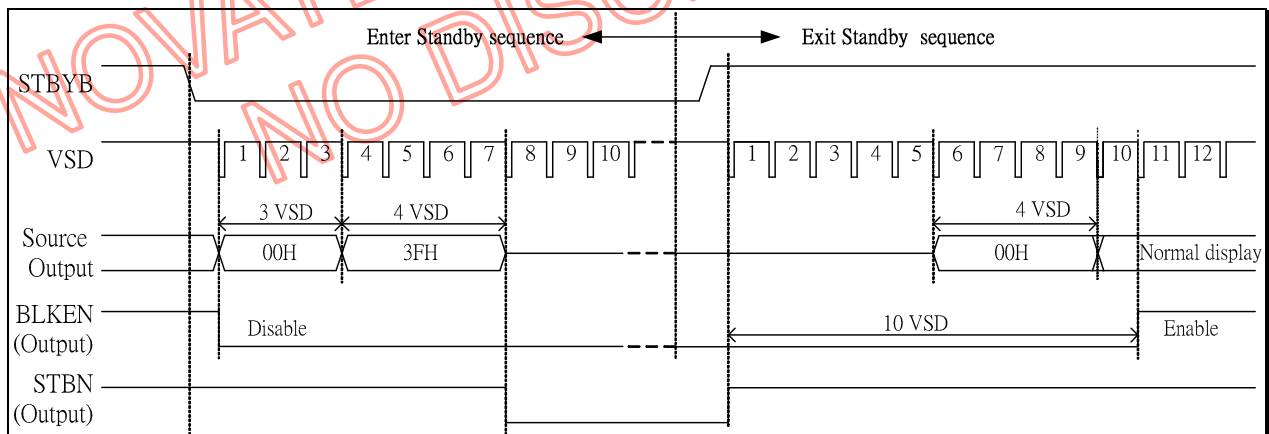

Input Data VS Output Channels
CFSEL="1", Stripe Mode

(1) SHLR="1", right shift

Output	SO1	SO2	SO3	---	SO1198	SO1199	SO1200
Order	First data			→	Last data		
Odd Line /Gn	D07~D00	D27~D20	D17~D10	---	D07~D00	D27~D20	D17~D10
Odd Line /Gn+1	D17~D10	D07~D00	D27~D20	---	D17~D10	D07~D00	D27~D20
Even Line /Gn	D07~D00	D27~D20	D17~D10	---	D07~D00	D27~D20	D17~D10
Even Line /Gn+1	D17~D10	D07~D00	D27~D20	---	D17~D10	D07~D00	D27~D20

(2) SHLR="0", left shift

Output	SO1	SO2	SO3	---	SO1198	SO1199	SO1200
Order	Last data			←	First data		
Odd Line /Gn	D07~D00	D27~D20	D17~D10	---	D07~D00	D27~D20	D17~D10
Odd Line /Gn+1	D17~D10	D07~D00	D27~D20	---	D17~D10	D07~D00	D27~D20
Even Line /Gn	D07~D00	D27~D20	D17~D10	---	D07~D00	D27~D20	D17~D10
Even Line /Gn+1	D17~D10	D07~D00	D27~D20	---	D17~D10	D07~D00	D27~D20

CFSEL="0", Delta Mode

(1) SHLR="1", right shift

Output	SO1	SO2	SO3	---	SO1198	SO1199	SO1200
Order	First data			→	Last data		
Odd Line /Gn	D07~D00	D27~D20	D17~D10	---	D07~D00	D27~D20	D17~D10
Odd Line /Gn+1	D17~D10	D07~D00	D27~D20	---	D17~D10	D07~D00	D27~D20
Even Line /Gn	D17~D10	D07~D00	D27~D20	---	D17~D10	D07~D00	D27~D20
Even Line /Gn+1	D27~D20	D17~D10	D07~D00	---	D27~D20	D17~D10	D07~D00

(2) SHLR="0", left shift

Output	SO1	SO2	SO3	---	SO1198	SO1199	SO1200
Order	Last data			←	First data		
Odd Line /Gn	D07~D00	D27~D20	D17~D10	---	D07~D00	D27~D20	D17~D10
Odd Line /Gn+1	D17~D10	D07~D00	D27~D20	---	D17~D10	D07~D00	D27~D20
Even Line /Gn	D17~D10	D07~D00	D27~D20	---	D17~D10	D07~D00	D27~D20
Even Line /Gn+1	D27~D20	D17~D10	D07~D00	---	D27~D20	D17~D10	D07~D00

Input Data VS Output Voltage

The figure below shows the relationship between the input data and the output voltage. Refer to the following pages for the relative resistor values and voltage calculation method.

Gamma Tables vary for each customer. Contact Novatek for more detail information.

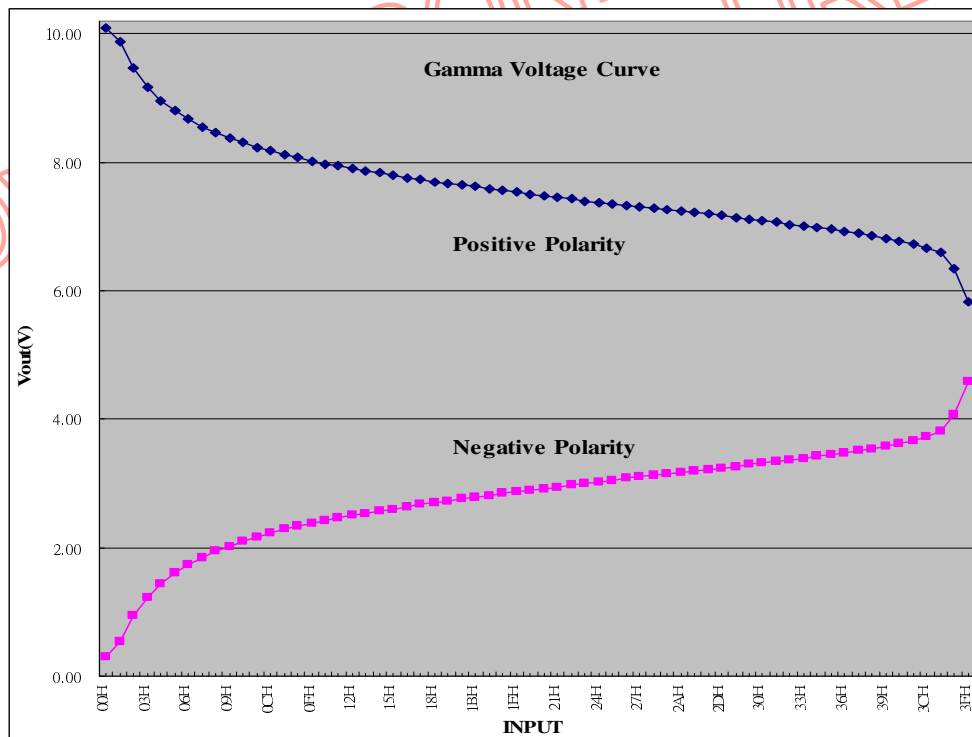

Remark: $AVDD-0.1 \geq V1 \geq V2 \geq V3 \geq V4 \geq V5 \geq V6 \geq V7;$
 $V8 \geq V9 \geq V10 \geq V11 \geq V12 \geq V13 \geq V14 \geq AGND+0.1V$

Input Data and Output Voltage Reference Table (VSET = "0")

Note: Gamma Tables vary for each custom. Contact Novatek for more detailed information.

@AVDD=10.4V

Chip Version	V1	V2	V3	V4	V5	V6	V7	V8	V9	V10	V11	V12	V13	V14	[unit]
	00H	01H	10H	20H	30H	3EH	3FH	3FH	3EH	30H	20H	10H	01H	00H	
NT39419B	10.004	9.755	8.153	7.774	7.511	7.15	6.55	5.35	4.647	3.66	3.11	2.445	0.48	0.204	V

Negative Polarity

Data	Negative Polarity	Data	Negative Polarity	Data	Negative Polarity
3FH	AVDD X 0.514095	2AH	AVDD X 0.331173	15H	AVDD X 0.258138
3EH	AVDD X 0.446886	29H	AVDD X 0.327767	14H	AVDD X 0.253994
3DH	AVDD X 0.42997	28H	AVDD X 0.324539	13H	AVDD X 0.249372
3CH	AVDD X 0.418345	27H	AVDD X 0.321407	12H	AVDD X 0.245052
3BH	AVDD X 0.40944	26H	AVDD X 0.318369	11H	AVDD X 0.24012
3AH	AVDD X 0.401224	25H	AVDD X 0.315036	10H	AVDD X 0.235175
39H	AVDD X 0.394664	24H	AVDD X 0.311887	0FH	AVDD X 0.230035
38H	AVDD X 0.388237	23H	AVDD X 0.308842	0EH	AVDD X 0.224393
37H	AVDD X 0.38275	22H	AVDD X 0.3059	0DH	AVDD X 0.218658
36H	AVDD X 0.3776	21H	AVDD X 0.302483	0CH	AVDD X 0.212346
35H	AVDD X 0.372563	20H	AVDD X 0.298992	0BH	AVDD X 0.205538
34H	AVDD X 0.368123	1FH	AVDD X 0.295628	0AH	AVDD X 0.198566
33H	AVDD X 0.363864	1EH	AVDD X 0.292303	09H	AVDD X 0.190248
32H	AVDD X 0.359704	1DH	AVDD X 0.288506	08H	AVDD X 0.181228
31H	AVDD X 0.355689	1CH	AVDD X 0.284932	07H	AVDD X 0.171244
30H	AVDD X 0.351912	1BH	AVDD X 0.281507	06H	AVDD X 0.159756
2FH	AVDD X 0.348236	1AH	AVDD X 0.277749	05H	AVDD X 0.146395
2EH	AVDD X 0.344652	19H	AVDD X 0.273866	04H	AVDD X 0.12996
2DH	AVDD X 0.341076	18H	AVDD X 0.270174	03H	AVDD X 0.109285
2CH	AVDD X 0.337684	17H	AVDD X 0.266387	02H	AVDD X 0.083529
2BH	AVDD X 0.334383	16H	AVDD X 0.262134	01H	AVDD X 0.046119
				00H	AVDD X 0.019598

Positive Polarity

Data	Positive Polarity	Data	Positive Polarity	Data	Positive Polarity
00H	AVDD X 0.962	15H	AVDD X 0.769	2AH	AVDD X 0.731
01H	AVDD X 0.938	16H	AVDD X 0.767	2BH	AVDD X 0.730
02H	AVDD X 0.905	17H	AVDD X 0.764	2CH	AVDD X 0.728
03H	AVDD X 0.883	18H	AVDD X 0.762	2DH	AVDD X 0.727
04H	AVDD X 0.865	19H	AVDD X 0.760	2EH	AVDD X 0.725
05H	AVDD X 0.851	1AH	AVDD X 0.758	2FH	AVDD X 0.724
06H	AVDD X 0.840	1BH	AVDD X 0.756	30H	AVDD X 0.722
07H	AVDD X 0.831	1CH	AVDD X 0.754	31H	AVDD X 0.721
08H	AVDD X 0.823	1DH	AVDD X 0.753	32H	AVDD X 0.719
09H	AVDD X 0.816	1EH	AVDD X 0.751	33H	AVDD X 0.718
0AH	AVDD X 0.810	1FH	AVDD X 0.749	34H	AVDD X 0.716
0BH	AVDD X 0.805	20H	AVDD X 0.748	35H	AVDD X 0.715
0CH	AVDD X 0.800	21H	AVDD X 0.746	36H	AVDD X 0.713
0DH	AVDD X 0.795	22H	AVDD X 0.744	37H	AVDD X 0.712
0EH	AVDD X 0.791	23H	AVDD X 0.742	38H	AVDD X 0.710
0FH	AVDD X 0.787	24H	AVDD X 0.741	39H	AVDD X 0.708
10H	AVDD X 0.784	25H	AVDD X 0.739	3AH	AVDD X 0.706
11H	AVDD X 0.781	26H	AVDD X 0.737	3BH	AVDD X 0.704
12H	AVDD X 0.777	27H	AVDD X 0.736	3CH	AVDD X 0.701
13H	AVDD X 0.775	28H	AVDD X 0.734	3DH	AVDD X 0.697
14H	AVDD X 0.772	29H	AVDD X 0.733	3EH	AVDD X 0.688
				3FH	AVDD X 0.629

Data Input Format

Vertical input timing

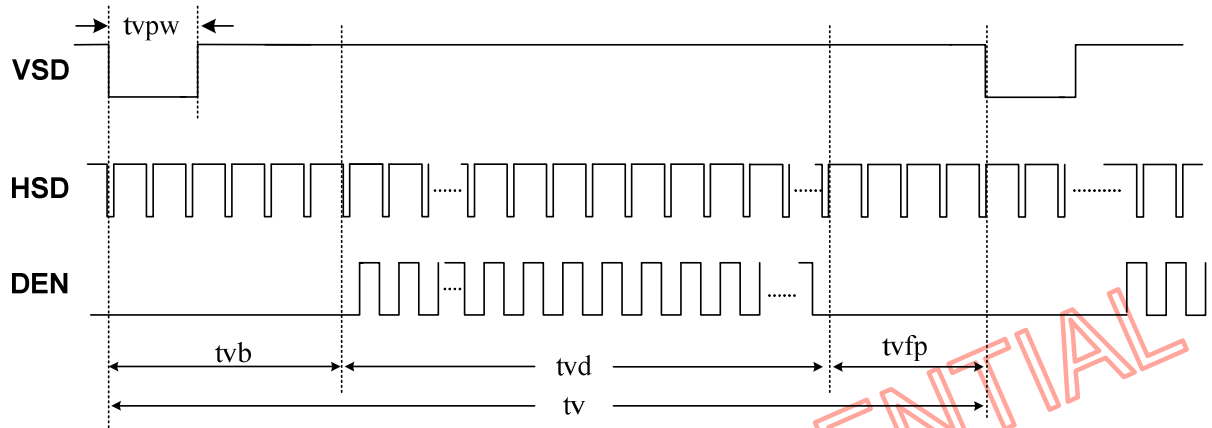

Horizontal input timing

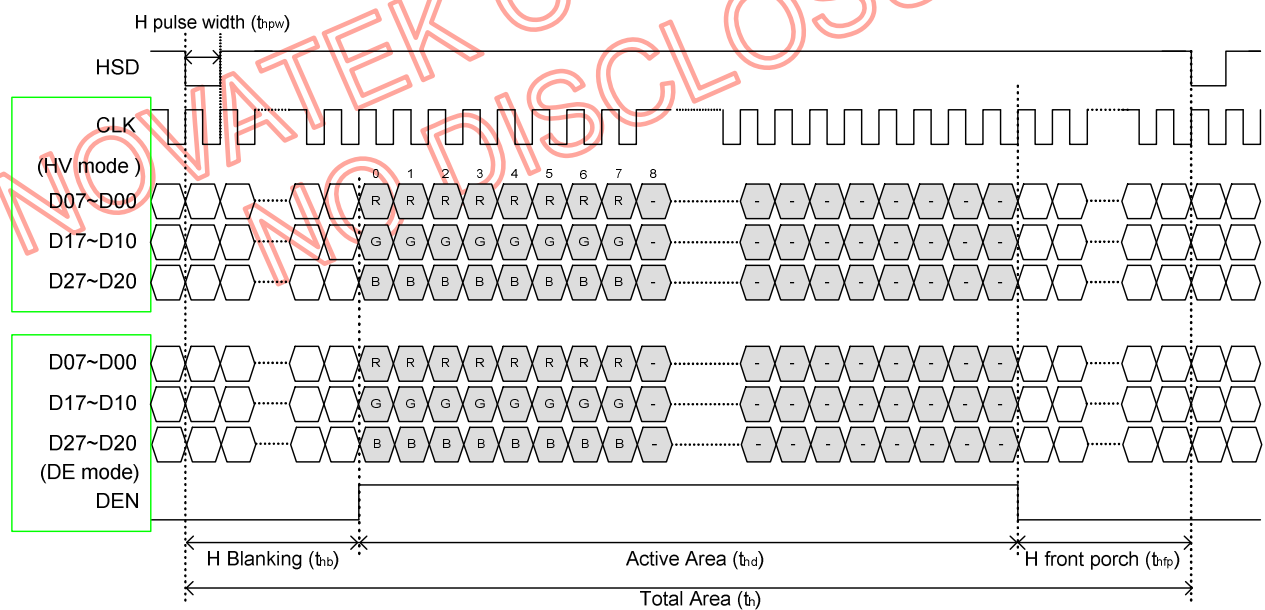

Timing Characteristic

For 800x480 panel

Horizontal input timing

Parameter		Symbol	Value			Unit
Horizontal display area		thd	800			DCLK
DCLK frequency		fclk	Min.	Typ.	Max.	MHz
			-	33.3	50	
1 Horizontal Line		th	862	1056	1200	DCLK
HSD pulse width	Min.	thpw	1			
	Typ.		-			
	Max.		40			
HSD Back Porch (Blanking)		thb	46	46	46	
HSD Front Porch		thfp	16	210	354	

Vertical input timing

Parameter	Symbol	Value			Unit
		Min.	Typ.	Max.	
Vertical display area	tvd	480			H
VSD period time	tv	510	525	650	H
VSD pulse width	tvpw	1	-	20	H
VSD Back Porch (Blanking)	tvb	23	23	23	H
VSD Front Porch	tvfp	7	22	147	H

For 800x600 panel
Horizontal input timing

Parameter		Symbol	Value			Unit
Horizontal display area		thd	800			DCLK
DCLK frequency		fclk	Min.	Typ.	Max.	MHz
			-	40	50	
1 Horizontal Line		th	862	1056	1200	DCLK
HSD pulse width	Min.	thpw	1			
	Typ.		-			
	Max.		40			
HSD Back Porch (Blanking)		thb	46	46	46	
HSD Front Porch		thfp	16	210	354	

Vertical input timing

Parameter	Symbol	Value			Unit
		Min.	Typ.	Max.	
Vertical display area	tvd	600			H
VSD period time	tv	624	635	700	H
VSD pulse width	tvpw	1	-	20	H
VSD Back Porch (Blanking)	tvb	23	23	23	H
VSD Front Porch	tvfp	1	12	77	H

Absolute Maximum Ratings

VOLTAGE

(GND = AGND = 0V, TA = 25°C)

	MIN.	MAX.	UNIT
Digital Supply Voltage, VDD	-0.5	+5.0	V
Analog Supply Voltage, AVDD, V1~V14	-0.5	+15.0	V

TEMPERATURE

	MIN.	MAX.	UNIT
Operating temperature	-20	+85	°C
Storage temperature	-55	+125	°C

*Comments

Stresses above those listed under "Absolute Maximum Ratings" may cause permanent damage to the device. These are stress ratings only. Functional operation of this device at these or any other conditions above those indicated in the operational sections of this specification is not implied and exposed to absolute maximum rating conditions for extended periods may affect device reliability.

Recommended Operating Range

(GND = AGND = 0V, TA = -20 to +85°C)

Parameter	Symbol	Min.	Typ.	Max.	Unit
Digital supply voltage	VDD	3.0	3.3	3.6	V
Analog supply voltage	AVDD	6.5	--	13.5	V
Digital input voltage	VIN	0	-	VDD	V

DC Electrical Characteristics

(VDD= 3.0 to 3.6V, AVDD= 6.5 to 13.5V, GND=AGND= 0V, TA= -20 to +85 °C)

Parameter	Symbol	Min.	Typ.	Max.	Unit	Conditions
Low level input voltage	Vil	0	-	0.3xVDD	V	For the digital circuit
High level input voltage	Vih	0.7xVDD	-	VDD	V	For the digital circuit
Input leakage current	Ii	-	-	±1	µA	For the digital circuit
High level output voltage	Voh	VDD-0.4	-	-	V	Ioh= -400µA
Low level output voltage	Vol	-	-	GND+0.4	V	Iol= +400µA
Pulled resistor low/high	Ri	150K	250K	350K	ohm	For the digital input pin @ VDD=3.3V
Digital Operation current	Idd	-	8	10	mA	DCLK=40 MHz,800x600, th=26.4us,VDD=3.3V
Digital Stand-by current	Ist1	-	10	50	µA	STBYB=0, Clock & data input pins keep low.
Analog Operating Current	Idda	-	10	12	mA	DCLK=40 MHz,800x600, th=26.4us,@AVDD=10V,V1=8V, V14=0.4V, No load
Analog Stand-by current	Ist2	-	10	50	µA	STBYB=0, Clock & data input pins keep low. No load.
Input level of V1 ~ V7	Vref1	0.4* AVDD	-	AVDD-0.1	V	Gamma correction voltage input
Input level of V8 ~ V14	Vref2	0.1	-	0.6* AVDD	V	Gamma correction voltage input
Output Voltage deviation	Vod1	-	±20	±35	mV	Vo = AGND+0.1V ~ AGND+0.5V & Vo = AVDD-0.5V ~ AVDD-0.1V
Output Voltage deviation	Vod2	-	±15	±20	mV	Vo = AGND+0.5V ~ AVDD-0.5V
Output Voltage Offset between Chips	Voc	-	-	±20	mV	Vo = AGND+0.5V ~ AVDD-0.5V
Dynamic Range of Output	Vdr	0.1	-	AVDD-0.1	V	SO1 ~ SO1200
Sinking Current of Outputs	IOLy	80	-	-	µA	SO1 ~ SO1200; Vo=0.1V v.s 1.0V , AVDD=13.5V
Driving Current of Outputs	IOHy	80	-	-	µA	SO1 ~ SO1200; Vo=13.4V v.s 12.5V , AVDD=13.5V
Resistance of Gamma Table	Rg	0.7*Rn	1.0*Rn	1.3*Rn	ohm	Rn: Internal gamma resistor

Parameter	Symbol	Min.	Typ.	Max.	Unit	Conditions
DCMP Buffer Output Voltage variation	VDvar	-	-	300	mV	AVDD = 10.4 V, Output = 20H, Isink or Isource = 3.5mA

AC Electrical Characteristics

(VDD= 3.0 to 3.6V, AVDD= 6.5 to 13.5V, GND=AGND= 0V, TA= -20 to +85°C)

Parameter	Symbol	Min.	Typ.	Max.	Unit	Conditions
VDD Power On Slew rate	T _{POR}	-	-	20	ms	From 0V to 90% VDD
RSTB pulse width	T _{Rst}	1	-	-	ms	CLKIN = 40MHz
CLKIN cycle time	T _{cph}	20	-	-	ns	
CLKIN pulse duty	T _{cwh}	40	50	60	%	
VSD setup time	T _{vst}	8	-	-	ns	
VSD hold time	T _{vhd}	8	-	-	ns	
HSD setup time	T _{hst}	8	-	-	ns	
HSD hold time	T _{hhd}	8	-	-	ns	
Data set-up time	T _{dsu}	8	-	-	ns	D0[7:0], D1[7:0], D2[7:0] to CLKIN
Data hold time	T _{dhd}	8	-	-	ns	D0[7:0], D1[7:0], D2[7:0] to CLKIN
DEN setup time	T _{esu}	8	-	-	ns	
DEN hold time	T _{ehd}	8	-	-	ns	
Output stable time	T _{sst}	-	-	6	us	10% to 90% target voltage. CL=120pF, R=10K ohm

Timing Table

Parallel 24-bit RGB Mode

Parameter	Symbol	Min.	Typ.	Max.	Unit	Conditions
CLKIN Frequency	F _{clk}	-	33.3	50	MHz	VDD = 3.0V ~3.6V
CLKIN Cycle Time	T _{clk}	20	30	-	ns	
CLKIN Pulse Duty	T _{cwh}	40	50	60	%	T _{clk} =T _{cwh} +cwl
	T _{cwl}	40	50	60	%	
VSD to STV	T _{stv}	-	24	-	H	HV mode
DEN to STV	T _{stv}	-	4	-	CLKIN	DE mode
STV pulse width	T _{wstv}	-	0.5	-	H	
STV to CKV	T _{ckv}	-	18	-	CLKIN	
STV to OEV	T _{oev}	-	2	-	CLKIN	
CKV Pulse Width	T _{wckv}	-	66	-	CLKIN	
OEV Pulse Width	T _{woev}	-	50	-	CLKIN	

Timing Diagram

Input Clock and Data Timing Diagram

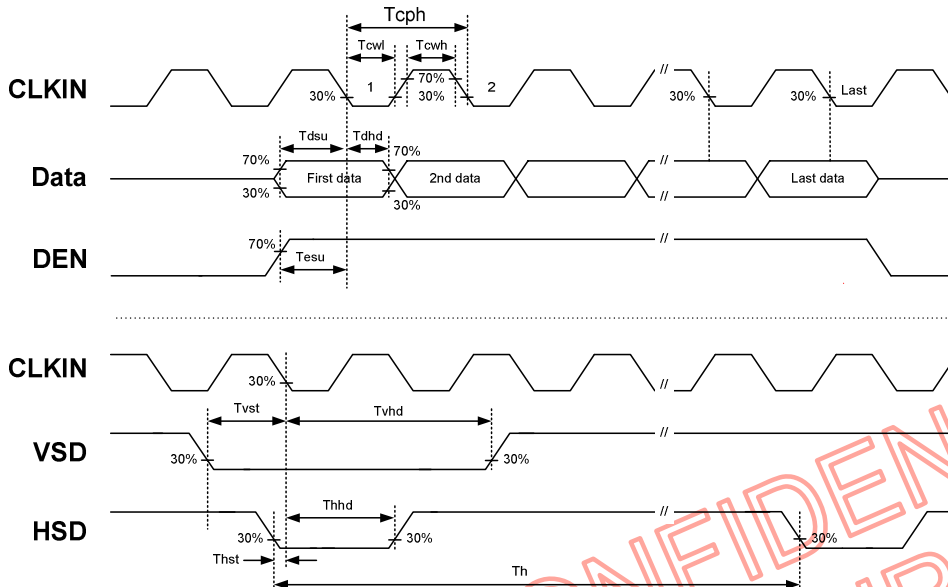

Source Output

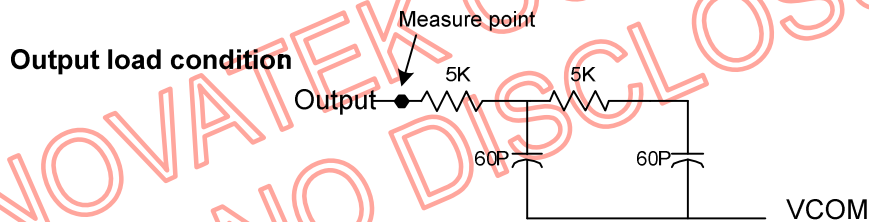

Vertical Timing Diagram (HV mode)

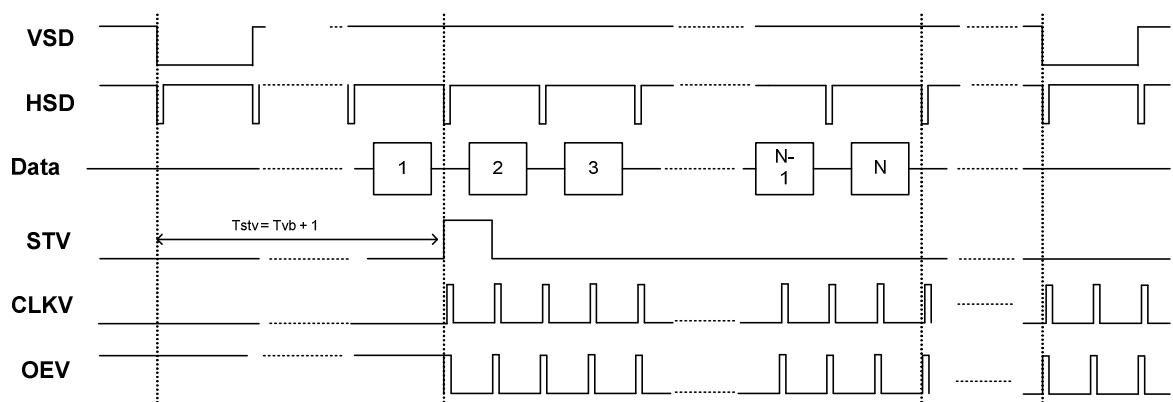

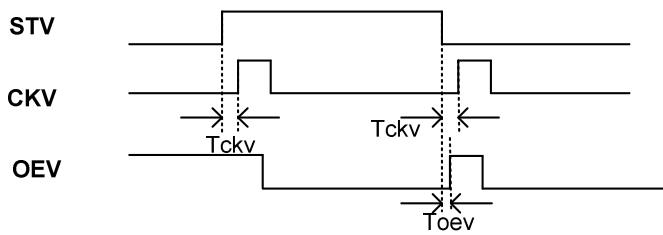
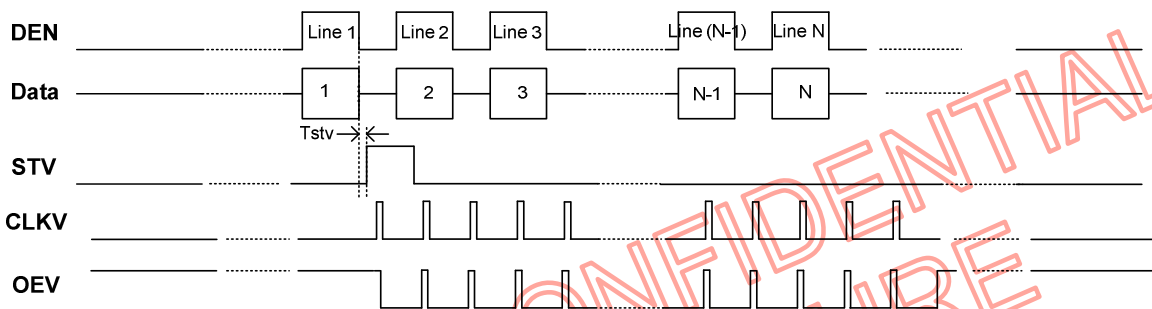

Vertical Timing Diagram (DE mode)

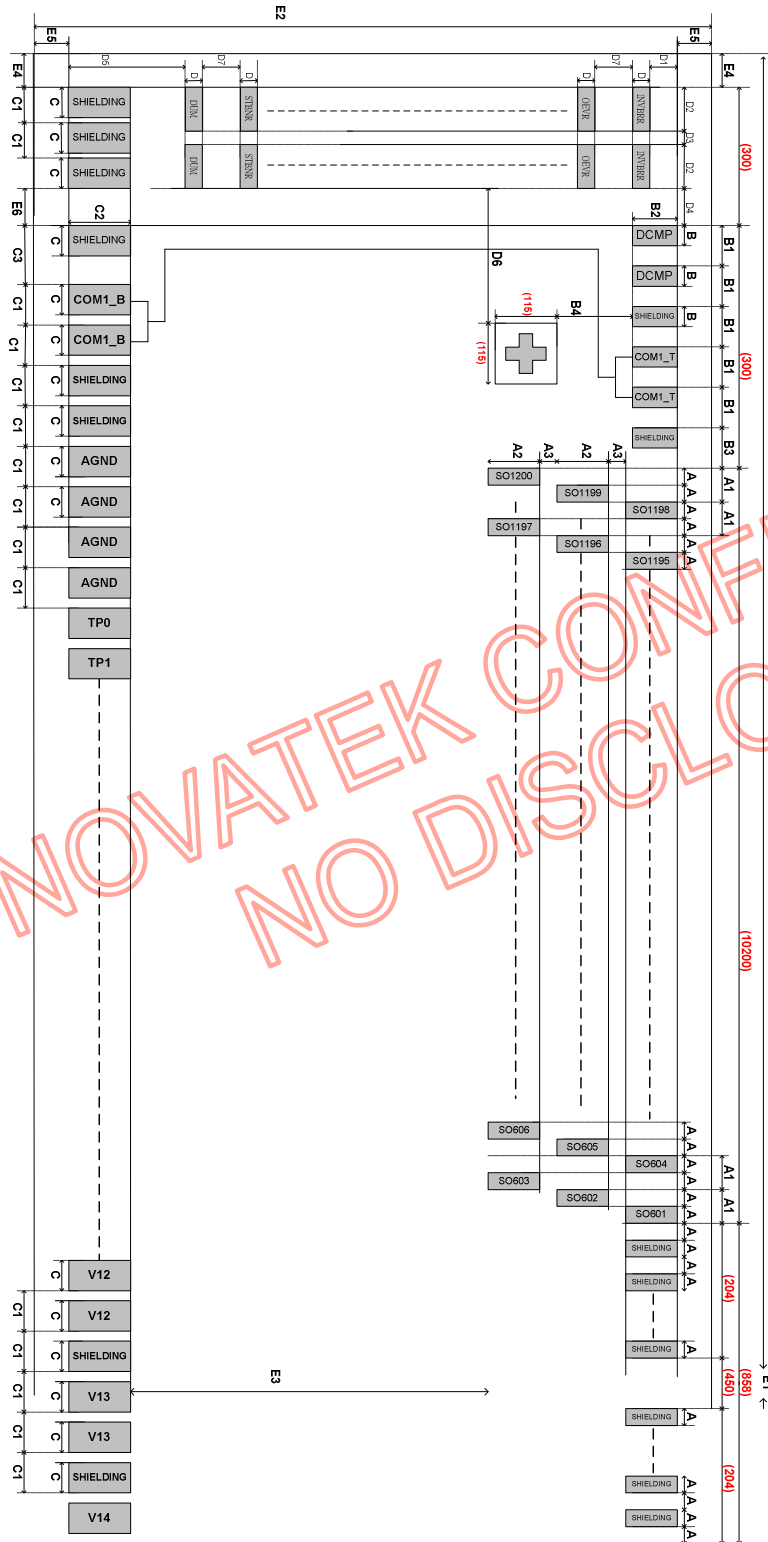
NOVATEK CONFIDENTIAL
NO DISCLOSURE

Pad Outline Dimension 1 (Bump Side)

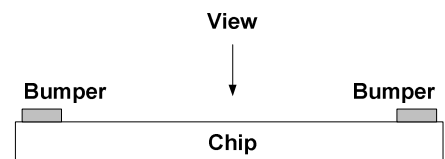
NOVATEK CONFIDENTIAL
NO DISCLOSURE

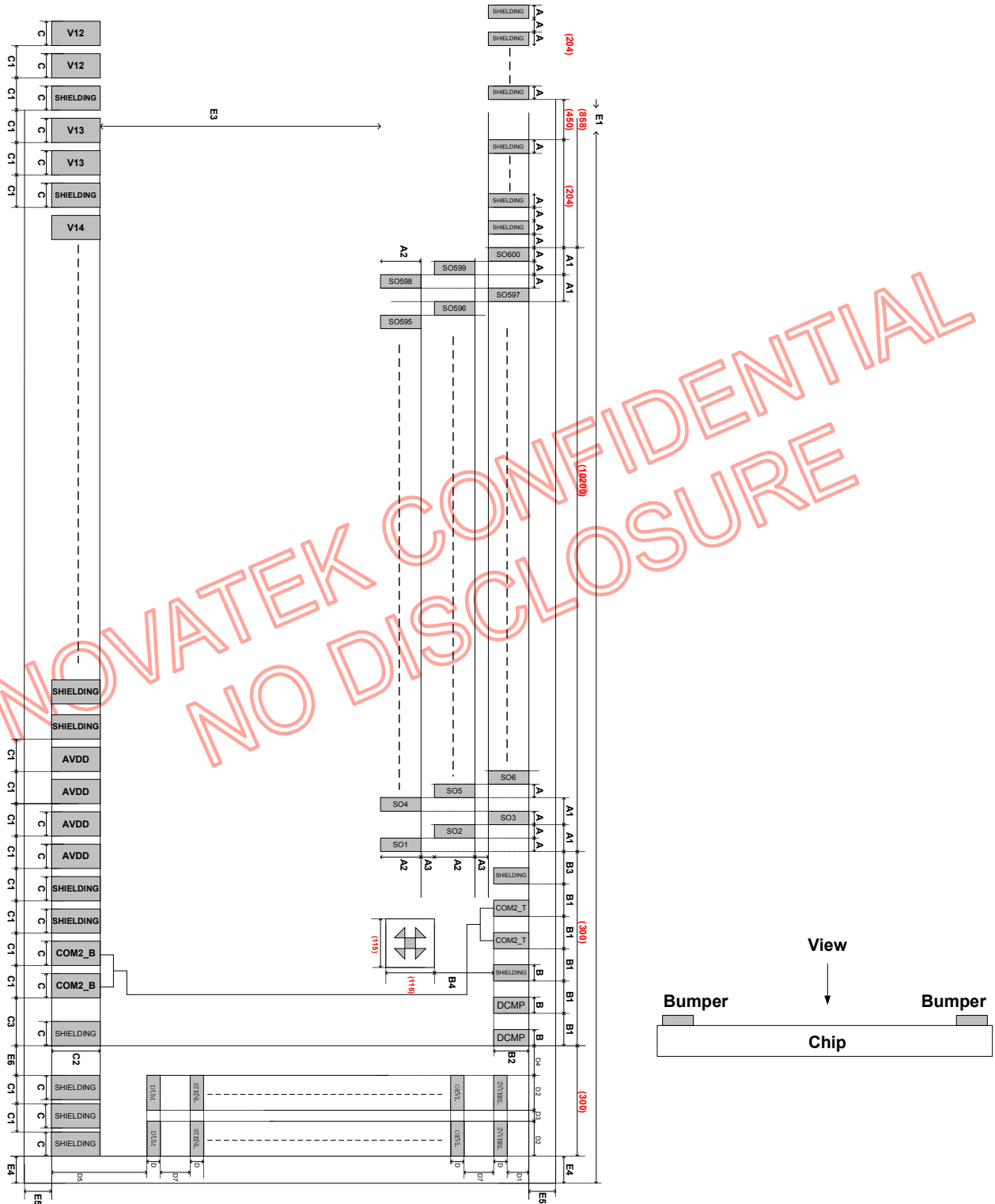

Pad Outline Dimension 2 (Bump Side)

Alignment Mark

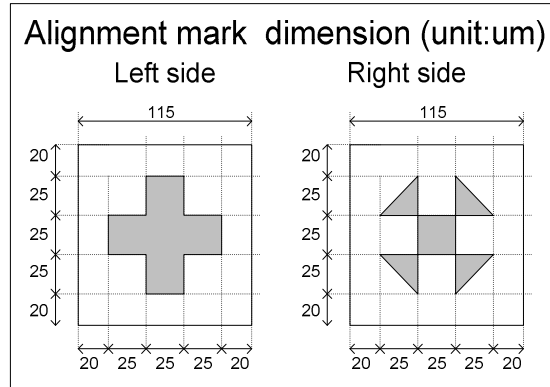

Pad Information

Symbol	Dimension (um)
A	17
A1	34
A2	110
A3	30
B	30
B1	50
B2	70
B3	50
B4	191.5
C	65
C1	85
C2	110
C3	115
D	30

Symbol	Dimension (um)
D1	40
D2	100
D3	30
D4	70
D5	266
D6	168.5
D7	50
E1	22572 (max)
E2	1040 (max)
E3	TBD
E4	57(max)
E5	57(max)
E6	136.5

***Note: Chip dimension includes scribe line.**

Appendix A: Pad Coordinates

No.	TextName	CX	CY	No.	TextName	CX	CY	No.	TextName	CX	CY
1	alignment_mark_l	-10773	144	35	SHIELDING[67]	-9690	-408	69	GOSEQ	-6800	-408
2	alignment_mark_r	10773	144	36	SHIELDING[66]	-9605	-408	70	GOSEQ	-6715	-408
3	INVBRR	-11179	408	37	TP0	-9520	-408	71	SHIELDING[21]	-6630	-408
4	OEVR	-11179	328	38	TP0	-9435	-408	72	BIST	-6545	-408
5	UDR	-11179	248	39	TP1	-9350	-408	73	BIST	-6460	-408
6	UDR	-11049	248	40	TP1	-9265	-408	74	SHIELDING[22]	-6375	-408
7	CKVR	-11179	168	41	TP2	-9180	-408	75	RES0	-6290	-408
8	CKVR	-11049	168	42	TP2	-9095	-408	76	RES0	-6205	-408
9	STV1R	-11179	88	43	TP3	-9010	-408	77	SHIELDING[23]	-6120	-408
10	STV1R	-11049	88	44	TP3	-8925	-408	78	CFSEL	-6035	-408
11	STV2R	-11179	8	45	TP4	-8840	-408	79	CFSEL	-5950	-408
12	STV2R	-11049	8	46	TP4	-8755	-408	80	SHIELDING[24]	-5865	-408
13	STV1R	-11179	-72	47	TP5	-8670	-408	81	CLKPOL	-5780	-408
14	STV1R	-11049	-72	48	TP5	-8585	-408	82	CLKPOL	-5695	-408
15	STBNR	-11179	-152	49	SHIELDING[65]	-8500	-408	83	SHIELDING[25]	-5610	-408
16	STBNR	-11049	-152	50	TB0	-8415	-408	84	DITHB	-5525	-408
17	DUMR[1]	-11179	-232	51	TB0	-8330	-408	85	DITHB	-5440	-408
18	DUMR[2]	-11049	-232	52	SHIELDING[64]	-8245	-408	86	SHIELDING[26]	-5355	-408
19	SHIELDING[75]	-11196.5	-408	53	TB1	-8160	-408	87	MODE	-5270	-408
20	SHIELDING[74]	-11111.5	-408	54	TB1	-8075	-408	88	MODE	-5185	-408
21	SHIELDING[73]	-11026.5	-408	55	SHIELDING[13]	-7990	-408	89	SHIELDING[27]	-5100	-408
22	SHIELDING[72]	-10825	-408	56	SHIELDING[14]	-7905	-408	90	SHLR	-5015	-408
23	COM1_B	-10710	-408	57	SHIELDING[15]	-7820	-408	91	SHLR	-4930	-408
24	COM1_B	-10625	-408	58	SHIELDING[16]	-7735	-408	92	SHIELDING[28]	-4845	-408
25	SHIELDING[80]	-10540	-408	59	TB2	-7650	-408	93	UPDN	-4760	-408
26	SHIELDING[79]	-10455	-408	60	TB2	-7565	-408	94	UPDN	-4675	-408
27	AGND	-10370	-408	61	SHIELDING[17]	-7480	-408	95	SHIELDING[29]	-4590	-408
28	AGND	-10285	-408	62	TB3	-7395	-408	96	STBYB	-4505	-408
29	AGND	-10200	-408	63	TB3	-7310	-408	97	STBYB	-4420	-408
30	AGND	-10115	-408	64	SHIELDING[18]	-7225	-408	98	SHIELDING[30]	-4335	-408
31	SHIELDING[71]	-10030	-408	65	TB4	-7140	-408	99	RSTB	-4250	-408
32	SHIELDING[70]	-9945	-408	66	TB4	-7055	-408	100	RSTB	-4165	-408
33	SHIELDING[69]	-9860	-408	67	SHIELDING[19]	-6970	-408	101	SHIELDING[31]	-4080	-408
34	SHIELDING[68]	-9775	-408	68	SHIELDING[20]	-6885	-408	102	BLKEN	-3995	-408

No.	TextName	CX	CY	No.	TextName	CX	CY	No.	TextName	CX	CY
103	BLKEN	-3910	-408	137	SHIELDING[37]	-1020	-408	171	AGND	1870	-408
104	SHIELDING[32]	-3825	-408	138	V4	-935	-408	172	AGND	1955	-408
105	VSET	-3740	-408	139	V4	-850	-408	173	AGND	2040	-408
106	VSET	-3655	-408	140	SHIELDING[38]	-765	-408	174	AGND	2125	-408
107	TP6	-3570	-408	141	V5	-680	-408	175	AGND	2210	-408
108	TP7	-3485	-408	142	V5	-595	-408	176	AGND	2295	-408
109	TP8	-3400	-408	143	SHIELDING[39]	-510	-408	177	AGND	2380	-408
110	TP9	-3315	-408	144	V6	-425	-408	178	AGND	2465	-408
111	TP10	-3230	-408	145	V6	-340	-408	179	SHIELDING[49]	2550	-408
112	TP11	-3145	-408	146	SHIELDING[40]	-255	-408	180	SHIELDING[50]	2635	-408
113	TP12	-3060	-408	147	V7	-170	-408	181	GND	2720	-408
114	TP13	-2975	-408	148	V7	-85	-408	182	GND	2805	-408
115	TP14	-2890	-408	149	SHIELDING[41]	0	-408	183	GND	2890	-408
116	GND	-2805	-408	150	V8	85	-408	184	GND	2975	-408
117	DCMP_EN	-2720	-408	151	V8	170	-408	185	SHIELDING[51]	3060	-408
118	VCC	-2635	-408	152	SHIELDING[42]	255	-408	186	SHIELDING[52]	3145	-408
119	SHIELDING[33]	-2550	-408	153	V9	340	-408	187	VCC	3230	-408
120	AVDD	-2465	-408	154	V9	425	-408	188	VCC	3315	-408
121	AVDD	-2380	-408	155	SHIELDING[43]	510	-408	189	VCC	3400	-408
122	AVDD	-2295	-408	156	V10	595	-408	190	VCC	3485	-408
123	AVDD	-2210	-408	157	V10	680	-408	191	DASHD[1]	3570	-408
124	AVDD	-2125	-408	158	SHIELDING[44]	765	-408	192	VSD	3655	-408
125	AVDD	-2040	-408	159	V11	850	-408	193	VSD	3740	-408
126	AVDD	-1955	-408	160	V11	935	-408	194	DASHD[2]	3825	-408
127	AVDD	-1870	-408	161	SHIELDING[45]	1020	-408	195	HSD	3910	-408
128	SHIELDING[34]	-1785	-408	162	V12	1105	-408	196	HSD	3995	-408
129	V1	-1700	-408	163	V12	1190	-408	197	DASHD[3]	4080	-408
130	V1	-1615	-408	164	SHIELDING[46]	1275	-408	198	DEN	4165	-408
131	SHIELDING[35]	-1530	-408	165	V13	1360	-408	199	DEN	4250	-408
132	V2	-1445	-408	166	V13	1445	-408	200	DASHD[4]	4335	-408
133	V2	-1360	-408	167	SHIELDING[47]	1530	-408	201	CLKIN	4420	-408
134	SHIELDING[36]	-1275	-408	168	V14	1615	-408	202	CLKIN	4505	-408
135	V3	-1190	-408	169	V14	1700	-408	203	DASHD[5]	4590	-408
136	V3	-1105	-408	170	SHIELDING[48]	1785	-408	204	D27	4675	-408

No.	TextName	CX	CY	No.	TextName	CX	CY	No.	TextName	CX	CY
205	D27	4760	-408	239	D11	7650	-408	273	SHIELDING[58]	10540	-408
206	D26	4845	-408	240	D11	7735	-408	274	COM2_B	10625	-408
207	D26	4930	-408	241	D10	7820	-408	275	COM2_B	10710	-408
208	DASHD[6]	5015	-408	242	D10	7905	-408	276	SHIELDING[59]	10825	-408
209	D25	5100	-408	243	DASHD[13]	7990	-408	277	SHIELDING[60]	11026.5	-408
210	D25	5185	-408	244	D07	8075	-408	278	SHIELDING[61]	11111.5	-408
211	D24	5270	-408	245	D07	8160	-408	279	SHIELDING[62]	11196.5	-408
212	D24	5355	-408	246	D06	8245	-408	280	DUML[1]	11049	-232
213	DASHD[7]	5440	-408	247	D06	8330	-408	281	DUML[2]	11179	-232
214	D23	5525	-408	248	DASHD[14]	8415	-408	282	STBNL	11049	-152
215	D23	5610	-408	249	D05	8500	-408	283	STBNL	11179	-152
216	D22	5695	-408	250	D05	8585	-408	284	STV1L	11049	-72
217	D22	5780	-408	251	D04	8670	-408	285	STV1L	11179	-72
218	DASHD[8]	5865	-408	252	D04	8755	-408	286	STV2L	11049	8
219	D21	5950	-408	253	DASHD[15]	8840	-408	287	STV2L	11179	8
220	D21	6035	-408	254	D03	8925	-408	288	STV1L	11049	88
221	D20	6120	-408	255	D03	9010	-408	289	STV1L	11179	88
222	D20	6205	-408	256	D02	9095	-408	290	CKVL	11049	168
223	DASHD[9]	6290	-408	257	D02	9180	-408	291	CKVL	11179	168
224	D17	6375	-408	258	DASHD[16]	9265	-408	292	UDL	11049	248
225	D17	6460	-408	259	D01	9350	-408	293	UDL	11179	248
226	D16	6545	-408	260	D01	9435	-408	294	OEVL	11179	328
227	D16	6630	-408	261	D00	9520	-408	295	INVBRL	11179	408
228	DASHD[10]	6715	-408	262	D00	9605	-408	296	OEVL	11049	328
229	D15	6800	-408	263	DASHD[17]	9690	-408	297	INVBRL	11049	408
230	D15	6885	-408	264	SHIELDING[53]	9775	-408	298	DCMPL	10914	428
231	D14	6970	-408	265	SHIELDING[54]	9860	-408	299	DCMPL	10864	428
232	D14	7055	-408	266	SHIELDING[55]	9945	-408	300	SHIELDING[78]	10814	428
233	DASHD[11]	7140	-408	267	SHIELDING[56]	10030	-408	301	COM2_T	10764	428
234	D13	7225	-408	268	AVDD	10115	-408	302	COM2_T	10714	428
235	D13	7310	-408	269	AVDD	10200	-408	303	SHIELDING[63]	10664	428
236	D12	7395	-408	270	AVDD	10285	-408	304	SO[1]	10620.5	128
237	D12	7480	-408	271	AVDD	10370	-408	305	SO[2]	10603.5	268
238	DASHD[12]	7565	-408	272	SHIELDING[57]	10455	-408	306	SO[3]	10586.5	408

No.	TextName	CX	CY	No.	TextName	CX	CY	No.	TextName	CX	CY
307	SO[4]	10569.5	128	341	SO[38]	9991.5	268	375	SO[72]	9413.5	408
308	SO[5]	10552.5	268	342	SO[39]	9974.5	408	376	SO[73]	9396.5	128
309	SO[6]	10535.5	408	343	SO[40]	9957.5	128	377	SO[74]	9379.5	268
310	SO[7]	10518.5	128	344	SO[41]	9940.5	268	378	SO[75]	9362.5	408
311	SO[8]	10501.5	268	345	SO[42]	9923.5	408	379	SO[76]	9345.5	128
312	SO[9]	10484.5	408	346	SO[43]	9906.5	128	380	SO[77]	9328.5	268
313	SO[10]	10467.5	128	347	SO[44]	9889.5	268	381	SO[78]	9311.5	408
314	SO[11]	10450.5	268	348	SO[45]	9872.5	408	382	SO[79]	9294.5	128
315	SO[12]	10433.5	408	349	SO[46]	9855.5	128	383	SO[80]	9277.5	268
316	SO[13]	10416.5	128	350	SO[47]	9838.5	268	384	SO[81]	9260.5	408
317	SO[14]	10399.5	268	351	SO[48]	9821.5	408	385	SO[82]	9243.5	128
318	SO[15]	10382.5	408	352	SO[49]	9804.5	128	386	SO[83]	9226.5	268
319	SO[16]	10365.5	128	353	SO[50]	9787.5	268	387	SO[84]	9209.5	408
320	SO[17]	10348.5	268	354	SO[51]	9770.5	408	388	SO[85]	9192.5	128
321	SO[18]	10331.5	408	355	SO[52]	9753.5	128	389	SO[86]	9175.5	268
322	SO[19]	10314.5	128	356	SO[53]	9736.5	268	390	SO[87]	9158.5	408
323	SO[20]	10297.5	268	357	SO[54]	9719.5	408	391	SO[88]	9141.5	128
324	SO[21]	10280.5	408	358	SO[55]	9702.5	128	392	SO[89]	9124.5	268
325	SO[22]	10263.5	128	359	SO[56]	9685.5	268	393	SO[90]	9107.5	408
326	SO[23]	10246.5	268	360	SO[57]	9668.5	408	394	SO[91]	9090.5	128
327	SO[24]	10229.5	408	361	SO[58]	9651.5	128	395	SO[92]	9073.5	268
328	SO[25]	10212.5	128	362	SO[59]	9634.5	268	396	SO[93]	9056.5	408
329	SO[26]	10195.5	268	363	SO[60]	9617.5	408	397	SO[94]	9039.5	128
330	SO[27]	10178.5	408	364	SO[61]	9600.5	128	398	SO[95]	9022.5	268
331	SO[28]	10161.5	128	365	SO[62]	9583.5	268	399	SO[96]	9005.5	408
332	SO[29]	10144.5	268	366	SO[63]	9566.5	408	400	SO[97]	8988.5	128
333	SO[30]	10127.5	408	367	SO[64]	9549.5	128	401	SO[98]	8971.5	268
334	SO[31]	10110.5	128	368	SO[65]	9532.5	268	402	SO[99]	8954.5	408
335	SO[32]	10093.5	268	369	SO[66]	9515.5	408	403	SO[100]	8937.5	128
336	SO[33]	10076.5	408	370	SO[67]	9498.5	128	404	SO[101]	8920.5	268
337	SO[34]	10059.5	128	371	SO[68]	9481.5	268	405	SO[102]	8903.5	408
338	SO[35]	10042.5	268	372	SO[69]	9464.5	408	406	SO[103]	8886.5	128
339	SO[36]	10025.5	408	373	SO[70]	9447.5	128	407	SO[104]	8869.5	268
340	SO[37]	10008.5	128	374	SO[71]	9430.5	268	408	SO[105]	8852.5	408

No.	TextName	CX	CY	No.	TextName	CX	CY	No.	TextName	CX	CY
409	SO[106]	8835.5	128	443	SO[140]	8257.5	268	477	SO[174]	7679.5	408
410	SO[107]	8818.5	268	444	SO[141]	8240.5	408	478	SO[175]	7662.5	128
411	SO[108]	8801.5	408	445	SO[142]	8223.5	128	479	SO[176]	7645.5	268
412	SO[109]	8784.5	128	446	SO[143]	8206.5	268	480	SO[177]	7628.5	408
413	SO[110]	8767.5	268	447	SO[144]	8189.5	408	481	SO[178]	7611.5	128
414	SO[111]	8750.5	408	448	SO[145]	8172.5	128	482	SO[179]	7594.5	268
415	SO[112]	8733.5	128	449	SO[146]	8155.5	268	483	SO[180]	7577.5	408
416	SO[113]	8716.5	268	450	SO[147]	8138.5	408	484	SO[181]	7560.5	128
417	SO[114]	8699.5	408	451	SO[148]	8121.5	128	485	SO[182]	7543.5	268
418	SO[115]	8682.5	128	452	SO[149]	8104.5	268	486	SO[183]	7526.5	408
419	SO[116]	8665.5	268	453	SO[150]	8087.5	408	487	SO[184]	7509.5	128
420	SO[117]	8648.5	408	454	SO[151]	8070.5	128	488	SO[185]	7492.5	268
421	SO[118]	8631.5	128	455	SO[152]	8053.5	268	489	SO[186]	7475.5	408
422	SO[119]	8614.5	268	456	SO[153]	8036.5	408	490	SO[187]	7458.5	128
423	SO[120]	8597.5	408	457	SO[154]	8019.5	128	491	SO[188]	7441.5	268
424	SO[121]	8580.5	128	458	SO[155]	8002.5	268	492	SO[189]	7424.5	408
425	SO[122]	8563.5	268	459	SO[156]	7985.5	408	493	SO[190]	7407.5	128
426	SO[123]	8546.5	408	460	SO[157]	7968.5	128	494	SO[191]	7390.5	268
427	SO[124]	8529.5	128	461	SO[158]	7951.5	268	495	SO[192]	7373.5	408
428	SO[125]	8512.5	268	462	SO[159]	7934.5	408	496	SO[193]	7356.5	128
429	SO[126]	8495.5	408	463	SO[160]	7917.5	128	497	SO[194]	7339.5	268
430	SO[127]	8478.5	128	464	SO[161]	7900.5	268	498	SO[195]	7322.5	408
431	SO[128]	8461.5	268	465	SO[162]	7883.5	408	499	SO[196]	7305.5	128
432	SO[129]	8444.5	408	466	SO[163]	7866.5	128	500	SO[197]	7288.5	268
433	SO[130]	8427.5	128	467	SO[164]	7849.5	268	501	SO[198]	7271.5	408
434	SO[131]	8410.5	268	468	SO[165]	7832.5	408	502	SO[199]	7254.5	128
435	SO[132]	8393.5	408	469	SO[166]	7815.5	128	503	SO[200]	7237.5	268
436	SO[133]	8376.5	128	470	SO[167]	7798.5	268	504	SO[201]	7220.5	408
437	SO[134]	8359.5	268	471	SO[168]	7781.5	408	505	SO[202]	7203.5	128
438	SO[135]	8342.5	408	472	SO[169]	7764.5	128	506	SO[203]	7186.5	268
439	SO[136]	8325.5	128	473	SO[170]	7747.5	268	507	SO[204]	7169.5	408
440	SO[137]	8308.5	268	474	SO[171]	7730.5	408	508	SO[205]	7152.5	128
441	SO[138]	8291.5	408	475	SO[172]	7713.5	128	509	SO[206]	7135.5	268
442	SO[139]	8274.5	128	476	SO[173]	7696.5	268	510	SO[207]	7118.5	408

No.	TextName	CX	CY	No.	TextName	CX	CY	No.	TextName	CX	CY
511	SO[208]	7101.5	128	545	SO[242]	6523.5	268	579	SO[276]	5945.5	408
512	SO[209]	7084.5	268	546	SO[243]	6506.5	408	580	SO[277]	5928.5	128
513	SO[210]	7067.5	408	547	SO[244]	6489.5	128	581	SO[278]	5911.5	268
514	SO[211]	7050.5	128	548	SO[245]	6472.5	268	582	SO[279]	5894.5	408
515	SO[212]	7033.5	268	549	SO[246]	6455.5	408	583	SO[280]	5877.5	128
516	SO[213]	7016.5	408	550	SO[247]	6438.5	128	584	SO[281]	5860.5	268
517	SO[214]	6999.5	128	551	SO[248]	6421.5	268	585	SO[282]	5843.5	408
518	SO[215]	6982.5	268	552	SO[249]	6404.5	408	586	SO[283]	5826.5	128
519	SO[216]	6965.5	408	553	SO[250]	6387.5	128	587	SO[284]	5809.5	268
520	SO[217]	6948.5	128	554	SO[251]	6370.5	268	588	SO[285]	5792.5	408
521	SO[218]	6931.5	268	555	SO[252]	6353.5	408	589	SO[286]	5775.5	128
522	SO[219]	6914.5	408	556	SO[253]	6336.5	128	590	SO[287]	5758.5	268
523	SO[220]	6897.5	128	557	SO[254]	6319.5	268	591	SO[288]	5741.5	408
524	SO[221]	6880.5	268	558	SO[255]	6302.5	408	592	SO[289]	5724.5	128
525	SO[222]	6863.5	408	559	SO[256]	6285.5	128	593	SO[290]	5707.5	268
526	SO[223]	6846.5	128	560	SO[257]	6268.5	268	594	SO[291]	5690.5	408
527	SO[224]	6829.5	268	561	SO[258]	6251.5	408	595	SO[292]	5673.5	128
528	SO[225]	6812.5	408	562	SO[259]	6234.5	128	596	SO[293]	5656.5	268
529	SO[226]	6795.5	128	563	SO[260]	6217.5	268	597	SO[294]	5639.5	408
530	SO[227]	6778.5	268	564	SO[261]	6200.5	408	598	SO[295]	5622.5	128
531	SO[228]	6761.5	408	565	SO[262]	6183.5	128	599	SO[296]	5605.5	268
532	SO[229]	6744.5	128	566	SO[263]	6166.5	268	600	SO[297]	5588.5	408
533	SO[230]	6727.5	268	567	SO[264]	6149.5	408	601	SO[298]	5571.5	128
534	SO[231]	6710.5	408	568	SO[265]	6132.5	128	602	SO[299]	5554.5	268
535	SO[232]	6693.5	128	569	SO[266]	6115.5	268	603	SO[300]	5537.5	408
536	SO[233]	6676.5	268	570	SO[267]	6098.5	408	604	SO[301]	5520.5	128
537	SO[234]	6659.5	408	571	SO[268]	6081.5	128	605	SO[302]	5503.5	268
538	SO[235]	6642.5	128	572	SO[269]	6064.5	268	606	SO[303]	5486.5	408
539	SO[236]	6625.5	268	573	SO[270]	6047.5	408	607	SO[304]	5469.5	128
540	SO[237]	6608.5	408	574	SO[271]	6030.5	128	608	SO[305]	5452.5	268
541	SO[238]	6591.5	128	575	SO[272]	6013.5	268	609	SO[306]	5435.5	408
542	SO[239]	6574.5	268	576	SO[273]	5996.5	408	610	SO[307]	5418.5	128
543	SO[240]	6557.5	408	577	SO[274]	5979.5	128	611	SO[308]	5401.5	268
544	SO[241]	6540.5	128	578	SO[275]	5962.5	268	612	SO[309]	5384.5	408

No.	TextName	CX	CY	No.	TextName	CX	CY	No.	TextName	CX	CY
613	SO[310]	5367.5	128	647	SO[344]	4789.5	268	681	SO[378]	4211.5	408
614	SO[311]	5350.5	268	648	SO[345]	4772.5	408	682	SO[379]	4194.5	128
615	SO[312]	5333.5	408	649	SO[346]	4755.5	128	683	SO[380]	4177.5	268
616	SO[313]	5316.5	128	650	SO[347]	4738.5	268	684	SO[381]	4160.5	408
617	SO[314]	5299.5	268	651	SO[348]	4721.5	408	685	SO[382]	4143.5	128
618	SO[315]	5282.5	408	652	SO[349]	4704.5	128	686	SO[383]	4126.5	268
619	SO[316]	5265.5	128	653	SO[350]	4687.5	268	687	SO[384]	4109.5	408
620	SO[317]	5248.5	268	654	SO[351]	4670.5	408	688	SO[385]	4092.5	128
621	SO[318]	5231.5	408	655	SO[352]	4653.5	128	689	SO[386]	4075.5	268
622	SO[319]	5214.5	128	656	SO[353]	4636.5	268	690	SO[387]	4058.5	408
623	SO[320]	5197.5	268	657	SO[354]	4619.5	408	691	SO[388]	4041.5	128
624	SO[321]	5180.5	408	658	SO[355]	4602.5	128	692	SO[389]	4024.5	268
625	SO[322]	5163.5	128	659	SO[356]	4585.5	268	693	SO[390]	4007.5	408
626	SO[323]	5146.5	268	660	SO[357]	4568.5	408	694	SO[391]	3990.5	128
627	SO[324]	5129.5	408	661	SO[358]	4551.5	128	695	SO[392]	3973.5	268
628	SO[325]	5112.5	128	662	SO[359]	4534.5	268	696	SO[393]	3956.5	408
629	SO[326]	5095.5	268	663	SO[360]	4517.5	408	697	SO[394]	3939.5	128
630	SO[327]	5078.5	408	664	SO[361]	4500.5	128	698	SO[395]	3922.5	268
631	SO[328]	5061.5	128	665	SO[362]	4483.5	268	699	SO[396]	3905.5	408
632	SO[329]	5044.5	268	666	SO[363]	4466.5	408	700	SO[397]	3888.5	128
633	SO[330]	5027.5	408	667	SO[364]	4449.5	128	701	SO[398]	3871.5	268
634	SO[331]	5010.5	128	668	SO[365]	4432.5	268	702	SO[399]	3854.5	408
635	SO[332]	4993.5	268	669	SO[366]	4415.5	408	703	SO[400]	3837.5	128
636	SO[333]	4976.5	408	670	SO[367]	4398.5	128	704	SO[401]	3820.5	268
637	SO[334]	4959.5	128	671	SO[368]	4381.5	268	705	SO[402]	3803.5	408
638	SO[335]	4942.5	268	672	SO[369]	4364.5	408	706	SO[403]	3786.5	128
639	SO[336]	4925.5	408	673	SO[370]	4347.5	128	707	SO[404]	3769.5	268
640	SO[337]	4908.5	128	674	SO[371]	4330.5	268	708	SO[405]	3752.5	408
641	SO[338]	4891.5	268	675	SO[372]	4313.5	408	709	SO[406]	3735.5	128
642	SO[339]	4874.5	408	676	SO[373]	4296.5	128	710	SO[407]	3718.5	268
643	SO[340]	4857.5	128	677	SO[374]	4279.5	268	711	SO[408]	3701.5	408
644	SO[341]	4840.5	268	678	SO[375]	4262.5	408	712	SO[409]	3684.5	128
645	SO[342]	4823.5	408	679	SO[376]	4245.5	128	713	SO[410]	3667.5	268
646	SO[343]	4806.5	128	680	SO[377]	4228.5	268	714	SO[411]	3650.5	408

No.	TextName	CX	CY	No.	TextName	CX	CY	No.	TextName	CX	CY
715	SO[412]	3633.5	128	749	SO[446]	3055.5	268	783	SO[480]	2477.5	408
716	SO[413]	3616.5	268	750	SO[447]	3038.5	408	784	SO[481]	2460.5	128
717	SO[414]	3599.5	408	751	SO[448]	3021.5	128	785	SO[482]	2443.5	268
718	SO[415]	3582.5	128	752	SO[449]	3004.5	268	786	SO[483]	2426.5	408
719	SO[416]	3565.5	268	753	SO[450]	2987.5	408	787	SO[484]	2409.5	128
720	SO[417]	3548.5	408	754	SO[451]	2970.5	128	788	SO[485]	2392.5	268
721	SO[418]	3531.5	128	755	SO[452]	2953.5	268	789	SO[486]	2375.5	408
722	SO[419]	3514.5	268	756	SO[453]	2936.5	408	790	SO[487]	2358.5	128
723	SO[420]	3497.5	408	757	SO[454]	2919.5	128	791	SO[488]	2341.5	268
724	SO[421]	3480.5	128	758	SO[455]	2902.5	268	792	SO[489]	2324.5	408
725	SO[422]	3463.5	268	759	SO[456]	2885.5	408	793	SO[490]	2307.5	128
726	SO[423]	3446.5	408	760	SO[457]	2868.5	128	794	SO[491]	2290.5	268
727	SO[424]	3429.5	128	761	SO[458]	2851.5	268	795	SO[492]	2273.5	408
728	SO[425]	3412.5	268	762	SO[459]	2834.5	408	796	SO[493]	2256.5	128
729	SO[426]	3395.5	408	763	SO[460]	2817.5	128	797	SO[494]	2239.5	268
730	SO[427]	3378.5	128	764	SO[461]	2800.5	268	798	SO[495]	2222.5	408
731	SO[428]	3361.5	268	765	SO[462]	2783.5	408	799	SO[496]	2205.5	128
732	SO[429]	3344.5	408	766	SO[463]	2766.5	128	800	SO[497]	2188.5	268
733	SO[430]	3327.5	128	767	SO[464]	2749.5	268	801	SO[498]	2171.5	408
734	SO[431]	3310.5	268	768	SO[465]	2732.5	408	802	SO[499]	2154.5	128
735	SO[432]	3293.5	408	769	SO[466]	2715.5	128	803	SO[500]	2137.5	268
736	SO[433]	3276.5	128	770	SO[467]	2698.5	268	804	SO[501]	2120.5	408
737	SO[434]	3259.5	268	771	SO[468]	2681.5	408	805	SO[502]	2103.5	128
738	SO[435]	3242.5	408	772	SO[469]	2664.5	128	806	SO[503]	2086.5	268
739	SO[436]	3225.5	128	773	SO[470]	2647.5	268	807	SO[504]	2069.5	408
740	SO[437]	3208.5	268	774	SO[471]	2630.5	408	808	SO[505]	2052.5	128
741	SO[438]	3191.5	408	775	SO[472]	2613.5	128	809	SO[506]	2035.5	268
742	SO[439]	3174.5	128	776	SO[473]	2596.5	268	810	SO[507]	2018.5	408
743	SO[440]	3157.5	268	777	SO[474]	2579.5	408	811	SO[508]	2001.5	128
744	SO[441]	3140.5	408	778	SO[475]	2562.5	128	812	SO[509]	1984.5	268
745	SO[442]	3123.5	128	779	SO[476]	2545.5	268	813	SO[510]	1967.5	408
746	SO[443]	3106.5	268	780	SO[477]	2528.5	408	814	SO[511]	1950.5	128
747	SO[444]	3089.5	408	781	SO[478]	2511.5	128	815	SO[512]	1933.5	268
748	SO[445]	3072.5	128	782	SO[479]	2494.5	268	816	SO[513]	1916.5	408

No.	TextName	CX	CY	No.	TextName	CX	CY	No.	TextName	CX	CY
817	SO[514]	1899.5	128	851	SO[548]	1321.5	268	885	SO[582]	743.5	408
818	SO[515]	1882.5	268	852	SO[549]	1304.5	408	886	SO[583]	726.5	128
819	SO[516]	1865.5	408	853	SO[550]	1287.5	128	887	SO[584]	709.5	268
820	SO[517]	1848.5	128	854	SO[551]	1270.5	268	888	SO[585]	692.5	408
821	SO[518]	1831.5	268	855	SO[552]	1253.5	408	889	SO[586]	675.5	128
822	SO[519]	1814.5	408	856	SO[553]	1236.5	128	890	SO[587]	658.5	268
823	SO[520]	1797.5	128	857	SO[554]	1219.5	268	891	SO[588]	641.5	408
824	SO[521]	1780.5	268	858	SO[555]	1202.5	408	892	SO[589]	624.5	128
825	SO[522]	1763.5	408	859	SO[556]	1185.5	128	893	SO[590]	607.5	268
826	SO[523]	1746.5	128	860	SO[557]	1168.5	268	894	SO[591]	590.5	408
827	SO[524]	1729.5	268	861	SO[558]	1151.5	408	895	SO[592]	573.5	128
828	SO[525]	1712.5	408	862	SO[559]	1134.5	128	896	SO[593]	556.5	268
829	SO[526]	1695.5	128	863	SO[560]	1117.5	268	897	SO[594]	539.5	408
830	SO[527]	1678.5	268	864	SO[561]	1100.5	408	898	SO[595]	522.5	128
831	SO[528]	1661.5	408	865	SO[562]	1083.5	128	899	SO[596]	505.5	268
832	SO[529]	1644.5	128	866	SO[563]	1066.5	268	900	SO[597]	488.5	408
833	SO[530]	1627.5	268	867	SO[564]	1049.5	408	901	SO[598]	471.5	128
834	SO[531]	1610.5	408	868	SO[565]	1032.5	128	902	SO[599]	454.5	268
835	SO[532]	1593.5	128	869	SO[566]	1015.5	268	903	SO[600]	437.5	408
836	SO[533]	1576.5	268	870	SO[567]	998.5	408	904	SHIELDING[1]	403.5	408
837	SO[534]	1559.5	408	871	SO[568]	981.5	128	905	SHIELDING[2]	369.5	408
838	SO[535]	1542.5	128	872	SO[569]	964.5	268	906	SHIELDING[3]	335.5	408
839	SO[536]	1525.5	268	873	SO[570]	947.5	408	907	SHIELDING[4]	301.5	408
840	SO[537]	1508.5	408	874	SO[571]	930.5	128	908	SHIELDING[5]	267.5	408
841	SO[538]	1491.5	128	875	SO[572]	913.5	268	909	SHIELDING[6]	233.5	408
842	SO[539]	1474.5	268	876	SO[573]	896.5	408	910	SHIELDING[7]	-233.5	408
843	SO[540]	1457.5	408	877	SO[574]	879.5	128	911	SHIELDING[8]	-267.5	408
844	SO[541]	1440.5	128	878	SO[575]	862.5	268	912	SHIELDING[9]	-301.5	408
845	SO[542]	1423.5	268	879	SO[576]	845.5	408	913	SHIELDING[10]	-335.5	408
846	SO[543]	1406.5	408	880	SO[577]	828.5	128	914	SHIELDING[11]	-369.5	408
847	SO[544]	1389.5	128	881	SO[578]	811.5	268	915	SHIELDING[12]	-403.5	408
848	SO[545]	1372.5	268	882	SO[579]	794.5	408	916	SO[601]	-437.5	408
849	SO[546]	1355.5	408	883	SO[580]	777.5	128	917	SO[602]	-454.5	268
850	SO[547]	1338.5	128	884	SO[581]	760.5	268	918	SO[603]	-471.5	128

No.	TextName	CX	CY	No.	TextName	CX	CY	No.	TextName	CX	CY
919	SO[604]	-488.5	408	953	SO[638]	-1066.5	268	987	SO[672]	-1644.5	128
920	SO[605]	-505.5	268	954	SO[639]	-1083.5	128	988	SO[673]	-1661.5	408
921	SO[606]	-522.5	128	955	SO[640]	-1100.5	408	989	SO[674]	-1678.5	268
922	SO[607]	-539.5	408	956	SO[641]	-1117.5	268	990	SO[675]	-1695.5	128
923	SO[608]	-556.5	268	957	SO[642]	-1134.5	128	991	SO[676]	-1712.5	408
924	SO[609]	-573.5	128	958	SO[643]	-1151.5	408	992	SO[677]	-1729.5	268
925	SO[610]	-590.5	408	959	SO[644]	-1168.5	268	993	SO[678]	-1746.5	128
926	SO[611]	-607.5	268	960	SO[645]	-1185.5	128	994	SO[679]	-1763.5	408
927	SO[612]	-624.5	128	961	SO[646]	-1202.5	408	995	SO[680]	-1780.5	268
928	SO[613]	-641.5	408	962	SO[647]	-1219.5	268	996	SO[681]	-1797.5	128
929	SO[614]	-658.5	268	963	SO[648]	-1236.5	128	997	SO[682]	-1814.5	408
930	SO[615]	-675.5	128	964	SO[649]	-1253.5	408	998	SO[683]	-1831.5	268
931	SO[616]	-692.5	408	965	SO[650]	-1270.5	268	999	SO[684]	-1848.5	128
932	SO[617]	-709.5	268	966	SO[651]	-1287.5	128	1000	SO[685]	-1865.5	408
933	SO[618]	-726.5	128	967	SO[652]	-1304.5	408	1001	SO[686]	-1882.5	268
934	SO[619]	-743.5	408	968	SO[653]	-1321.5	268	1002	SO[687]	-1899.5	128
935	SO[620]	-760.5	268	969	SO[654]	-1338.5	128	1003	SO[688]	-1916.5	408
936	SO[621]	-777.5	128	970	SO[655]	-1355.5	408	1004	SO[689]	-1933.5	268
937	SO[622]	-794.5	408	971	SO[656]	-1372.5	268	1005	SO[690]	-1950.5	128
938	SO[623]	-811.5	268	972	SO[657]	-1389.5	128	1006	SO[691]	-1967.5	408
939	SO[624]	-828.5	128	973	SO[658]	-1406.5	408	1007	SO[692]	-1984.5	268
940	SO[625]	-845.5	408	974	SO[659]	-1423.5	268	1008	SO[693]	-2001.5	128
941	SO[626]	-862.5	268	975	SO[660]	-1440.5	128	1009	SO[694]	-2018.5	408
942	SO[627]	-879.5	128	976	SO[661]	-1457.5	408	1010	SO[695]	-2035.5	268
943	SO[628]	-896.5	408	977	SO[662]	-1474.5	268	1011	SO[696]	-2052.5	128
944	SO[629]	-913.5	268	978	SO[663]	-1491.5	128	1012	SO[697]	-2069.5	408
945	SO[630]	-930.5	128	979	SO[664]	-1508.5	408	1013	SO[698]	-2086.5	268
946	SO[631]	-947.5	408	980	SO[665]	-1525.5	268	1014	SO[699]	-2103.5	128
947	SO[632]	-964.5	268	981	SO[666]	-1542.5	128	1015	SO[700]	-2120.5	408
948	SO[633]	-981.5	128	982	SO[667]	-1559.5	408	1016	SO[701]	-2137.5	268
949	SO[634]	-998.5	408	983	SO[668]	-1576.5	268	1017	SO[702]	-2154.5	128
950	SO[635]	-1015.5	268	984	SO[669]	-1593.5	128	1018	SO[703]	-2171.5	408
951	SO[636]	-1032.5	128	985	SO[670]	-1610.5	408	1019	SO[704]	-2188.5	268
952	SO[637]	-1049.5	408	986	SO[671]	-1627.5	268	1020	SO[705]	-2205.5	128

No.	TextName	CX	CY	No.	TextName	CX	CY	No.	TextName	CX	CY
1021	SO[706]	-2222.5	408	1055	SO[740]	-2800.5	268	1089	SO[774]	-3378.5	128
1022	SO[707]	-2239.5	268	1056	SO[741]	-2817.5	128	1090	SO[775]	-3395.5	408
1023	SO[708]	-2256.5	128	1057	SO[742]	-2834.5	408	1091	SO[776]	-3412.5	268
1024	SO[709]	-2273.5	408	1058	SO[743]	-2851.5	268	1092	SO[777]	-3429.5	128
1025	SO[710]	-2290.5	268	1059	SO[744]	-2868.5	128	1093	SO[778]	-3446.5	408
1026	SO[711]	-2307.5	128	1060	SO[745]	-2885.5	408	1094	SO[779]	-3463.5	268
1027	SO[712]	-2324.5	408	1061	SO[746]	-2902.5	268	1095	SO[780]	-3480.5	128
1028	SO[713]	-2341.5	268	1062	SO[747]	-2919.5	128	1096	SO[781]	-3497.5	408
1029	SO[714]	-2358.5	128	1063	SO[748]	-2936.5	408	1097	SO[782]	-3514.5	268
1030	SO[715]	-2375.5	408	1064	SO[749]	-2953.5	268	1098	SO[783]	-3531.5	128
1031	SO[716]	-2392.5	268	1065	SO[750]	-2970.5	128	1099	SO[784]	-3548.5	408
1032	SO[717]	-2409.5	128	1066	SO[751]	-2987.5	408	1100	SO[785]	-3565.5	268
1033	SO[718]	-2426.5	408	1067	SO[752]	-3004.5	268	1101	SO[786]	-3582.5	128
1034	SO[719]	-2443.5	268	1068	SO[753]	-3021.5	128	1102	SO[787]	-3599.5	408
1035	SO[720]	-2460.5	128	1069	SO[754]	-3038.5	408	1103	SO[788]	-3616.5	268
1036	SO[721]	-2477.5	408	1070	SO[755]	-3055.5	268	1104	SO[789]	-3633.5	128
1037	SO[722]	-2494.5	268	1071	SO[756]	-3072.5	128	1105	SO[790]	-3650.5	408
1038	SO[723]	-2511.5	128	1072	SO[757]	-3089.5	408	1106	SO[791]	-3667.5	268
1039	SO[724]	-2528.5	408	1073	SO[758]	-3106.5	268	1107	SO[792]	-3684.5	128
1040	SO[725]	-2545.5	268	1074	SO[759]	-3123.5	128	1108	SO[793]	-3701.5	408
1041	SO[726]	-2562.5	128	1075	SO[760]	-3140.5	408	1109	SO[794]	-3718.5	268
1042	SO[727]	-2579.5	408	1076	SO[761]	-3157.5	268	1110	SO[795]	-3735.5	128
1043	SO[728]	-2596.5	268	1077	SO[762]	-3174.5	128	1111	SO[796]	-3752.5	408
1044	SO[729]	-2613.5	128	1078	SO[763]	-3191.5	408	1112	SO[797]	-3769.5	268
1045	SO[730]	-2630.5	408	1079	SO[764]	-3208.5	268	1113	SO[798]	-3786.5	128
1046	SO[731]	-2647.5	268	1080	SO[765]	-3225.5	128	1114	SO[799]	-3803.5	408
1047	SO[732]	-2664.5	128	1081	SO[766]	-3242.5	408	1115	SO[800]	-3820.5	268
1048	SO[733]	-2681.5	408	1082	SO[767]	-3259.5	268	1116	SO[801]	-3837.5	128
1049	SO[734]	-2698.5	268	1083	SO[768]	-3276.5	128	1117	SO[802]	-3854.5	408
1050	SO[735]	-2715.5	128	1084	SO[769]	-3293.5	408	1118	SO[803]	-3871.5	268
1051	SO[736]	-2732.5	408	1085	SO[770]	-3310.5	268	1119	SO[804]	-3888.5	128
1052	SO[737]	-2749.5	268	1086	SO[771]	-3327.5	128	1120	SO[805]	-3905.5	408
1053	SO[738]	-2766.5	128	1087	SO[772]	-3344.5	408	1121	SO[806]	-3922.5	268
1054	SO[739]	-2783.5	408	1088	SO[773]	-3361.5	268	1122	SO[807]	-3939.5	128

No.	TextName	CX	CY	No.	TextName	CX	CY	No.	TextName	CX	CY
1123	SO[808]	-3956.5	408	1157	SO[842]	-4534.5	268	1191	SO[876]	-5112.5	128
1124	SO[809]	-3973.5	268	1158	SO[843]	-4551.5	128	1192	SO[877]	-5129.5	408
1125	SO[810]	-3990.5	128	1159	SO[844]	-4568.5	408	1193	SO[878]	-5146.5	268
1126	SO[811]	-4007.5	408	1160	SO[845]	-4585.5	268	1194	SO[879]	-5163.5	128
1127	SO[812]	-4024.5	268	1161	SO[846]	-4602.5	128	1195	SO[880]	-5180.5	408
1128	SO[813]	-4041.5	128	1162	SO[847]	-4619.5	408	1196	SO[881]	-5197.5	268
1129	SO[814]	-4058.5	408	1163	SO[848]	-4636.5	268	1197	SO[882]	-5214.5	128
1130	SO[815]	-4075.5	268	1164	SO[849]	-4653.5	128	1198	SO[883]	-5231.5	408
1131	SO[816]	-4092.5	128	1165	SO[850]	-4670.5	408	1199	SO[884]	-5248.5	268
1132	SO[817]	-4109.5	408	1166	SO[851]	-4687.5	268	1200	SO[885]	-5265.5	128
1133	SO[818]	-4126.5	268	1167	SO[852]	-4704.5	128	1201	SO[886]	-5282.5	408
1134	SO[819]	-4143.5	128	1168	SO[853]	-4721.5	408	1202	SO[887]	-5299.5	268
1135	SO[820]	-4160.5	408	1169	SO[854]	-4738.5	268	1203	SO[888]	-5316.5	128
1136	SO[821]	-4177.5	268	1170	SO[855]	-4755.5	128	1204	SO[889]	-5333.5	408
1137	SO[822]	-4194.5	128	1171	SO[856]	-4772.5	408	1205	SO[890]	-5350.5	268
1138	SO[823]	-4211.5	408	1172	SO[857]	-4789.5	268	1206	SO[891]	-5367.5	128
1139	SO[824]	-4228.5	268	1173	SO[858]	-4806.5	128	1207	SO[892]	-5384.5	408
1140	SO[825]	-4245.5	128	1174	SO[859]	-4823.5	408	1208	SO[893]	-5401.5	268
1141	SO[826]	-4262.5	408	1175	SO[860]	-4840.5	268	1209	SO[894]	-5418.5	128
1142	SO[827]	-4279.5	268	1176	SO[861]	-4857.5	128	1210	SO[895]	-5435.5	408
1143	SO[828]	-4296.5	128	1177	SO[862]	-4874.5	408	1211	SO[896]	-5452.5	268
1144	SO[829]	-4313.5	408	1178	SO[863]	-4891.5	268	1212	SO[897]	-5469.5	128
1145	SO[830]	-4330.5	268	1179	SO[864]	-4908.5	128	1213	SO[898]	-5486.5	408
1146	SO[831]	-4347.5	128	1180	SO[865]	-4925.5	408	1214	SO[899]	-5503.5	268
1147	SO[832]	-4364.5	408	1181	SO[866]	-4942.5	268	1215	SO[900]	-5520.5	128
1148	SO[833]	-4381.5	268	1182	SO[867]	-4959.5	128	1216	SO[901]	-5537.5	408
1149	SO[834]	-4398.5	128	1183	SO[868]	-4976.5	408	1217	SO[902]	-5554.5	268
1150	SO[835]	-4415.5	408	1184	SO[869]	-4993.5	268	1218	SO[903]	-5571.5	128
1151	SO[836]	-4432.5	268	1185	SO[870]	-5010.5	128	1219	SO[904]	-5588.5	408
1152	SO[837]	-4449.5	128	1186	SO[871]	-5027.5	408	1220	SO[905]	-5605.5	268
1153	SO[838]	-4466.5	408	1187	SO[872]	-5044.5	268	1221	SO[906]	-5622.5	128
1154	SO[839]	-4483.5	268	1188	SO[873]	-5061.5	128	1222	SO[907]	-5639.5	408
1155	SO[840]	-4500.5	128	1189	SO[874]	-5078.5	408	1223	SO[908]	-5656.5	268
1156	SO[841]	-4517.5	408	1190	SO[875]	-5095.5	268	1224	SO[909]	-5673.5	128



No.	TextName	CX	CY	No.	TextName	CX	CY	No.	TextName	CX	CY
1225	SO[910]	-5690.5	408	1259	SO[944]	-6268.5	268	1293	SO[978]	-6846.5	128
1226	SO[911]	-5707.5	268	1260	SO[945]	-6285.5	128	1294	SO[979]	-6863.5	408
1227	SO[912]	-5724.5	128	1261	SO[946]	-6302.5	408	1295	SO[980]	-6880.5	268
1228	SO[913]	-5741.5	408	1262	SO[947]	-6319.5	268	1296	SO[981]	-6897.5	128
1229	SO[914]	-5758.5	268	1263	SO[948]	-6336.5	128	1297	SO[982]	-6914.5	408
1230	SO[915]	-5775.5	128	1264	SO[949]	-6353.5	408	1298	SO[983]	-6931.5	268
1231	SO[916]	-5792.5	408	1265	SO[950]	-6370.5	268	1299	SO[984]	-6948.5	128
1232	SO[917]	-5809.5	268	1266	SO[951]	-6387.5	128	1300	SO[985]	-6965.5	408
1233	SO[918]	-5826.5	128	1267	SO[952]	-6404.5	408	1301	SO[986]	-6982.5	268
1234	SO[919]	-5843.5	408	1268	SO[953]	-6421.5	268	1302	SO[987]	-6999.5	128
1235	SO[920]	-5860.5	268	1269	SO[954]	-6438.5	128	1303	SO[988]	-7016.5	408
1236	SO[921]	-5877.5	128	1270	SO[955]	-6455.5	408	1304	SO[989]	-7033.5	268
1237	SO[922]	-5894.5	408	1271	SO[956]	-6472.5	268	1305	SO[990]	-7050.5	128
1238	SO[923]	-5911.5	268	1272	SO[957]	-6489.5	128	1306	SO[991]	-7067.5	408
1239	SO[924]	-5928.5	128	1273	SO[958]	-6506.5	408	1307	SO[992]	-7084.5	268
1240	SO[925]	-5945.5	408	1274	SO[959]	-6523.5	268	1308	SO[993]	-7101.5	128
1241	SO[926]	-5962.5	268	1275	SO[960]	-6540.5	128	1309	SO[994]	-7118.5	408
1242	SO[927]	-5979.5	128	1276	SO[961]	-6557.5	408	1310	SO[995]	-7135.5	268
1243	SO[928]	-5996.5	408	1277	SO[962]	-6574.5	268	1311	SO[996]	-7152.5	128
1244	SO[929]	-6013.5	268	1278	SO[963]	-6591.5	128	1312	SO[997]	-7169.5	408
1245	SO[930]	-6030.5	128	1279	SO[964]	-6608.5	408	1313	SO[998]	-7186.5	268
1246	SO[931]	-6047.5	408	1280	SO[965]	-6625.5	268	1314	SO[999]	-7203.5	128
1247	SO[932]	-6064.5	268	1281	SO[966]	-6642.5	128	1315	SO[1000]	-7220.5	408
1248	SO[933]	-6081.5	128	1282	SO[967]	-6659.5	408	1316	SO[1001]	-7237.5	268
1249	SO[934]	-6098.5	408	1283	SO[968]	-6676.5	268	1317	SO[1002]	-7254.5	128
1250	SO[935]	-6115.5	268	1284	SO[969]	-6693.5	128	1318	SO[1003]	-7271.5	408
1251	SO[936]	-6132.5	128	1285	SO[970]	-6710.5	408	1319	SO[1004]	-7288.5	268
1252	SO[937]	-6149.5	408	1286	SO[971]	-6727.5	268	1320	SO[1005]	-7305.5	128
1253	SO[938]	-6166.5	268	1287	SO[972]	-6744.5	128	1321	SO[1006]	-7322.5	408
1254	SO[939]	-6183.5	128	1288	SO[973]	-6761.5	408	1322	SO[1007]	-7339.5	268
1255	SO[940]	-6200.5	408	1289	SO[974]	-6778.5	268	1323	SO[1008]	-7356.5	128
1256	SO[941]	-6217.5	268	1290	SO[975]	-6795.5	128	1324	SO[1009]	-7373.5	408
1257	SO[942]	-6234.5	128	1291	SO[976]	-6812.5	408	1325	SO[1010]	-7390.5	268
1258	SO[943]	-6251.5	408	1292	SO[977]	-6829.5	268	1326	SO[1011]	-7407.5	128

No.	TextName	CX	CY	No.	TextName	CX	CY	No.	TextName	CX	CY
1327	SO[1012]	-7424.5	408	1361	SO[1046]	-8002.5	268	1395	SO[1080]	-8580.5	128
1328	SO[1013]	-7441.5	268	1362	SO[1047]	-8019.5	128	1396	SO[1081]	-8597.5	408
1329	SO[1014]	-7458.5	128	1363	SO[1048]	-8036.5	408	1397	SO[1082]	-8614.5	268
1330	SO[1015]	-7475.5	408	1364	SO[1049]	-8053.5	268	1398	SO[1083]	-8631.5	128
1331	SO[1016]	-7492.5	268	1365	SO[1050]	-8070.5	128	1399	SO[1084]	-8648.5	408
1332	SO[1017]	-7509.5	128	1366	SO[1051]	-8087.5	408	1400	SO[1085]	-8665.5	268
1333	SO[1018]	-7526.5	408	1367	SO[1052]	-8104.5	268	1401	SO[1086]	-8682.5	128
1334	SO[1019]	-7543.5	268	1368	SO[1053]	-8121.5	128	1402	SO[1087]	-8699.5	408
1335	SO[1020]	-7560.5	128	1369	SO[1054]	-8138.5	408	1403	SO[1088]	-8716.5	268
1336	SO[1021]	-7577.5	408	1370	SO[1055]	-8155.5	268	1404	SO[1089]	-8733.5	128
1337	SO[1022]	-7594.5	268	1371	SO[1056]	-8172.5	128	1405	SO[1090]	-8750.5	408
1338	SO[1023]	-7611.5	128	1372	SO[1057]	-8189.5	408	1406	SO[1091]	-8767.5	268
1339	SO[1024]	-7628.5	408	1373	SO[1058]	-8206.5	268	1407	SO[1092]	-8784.5	128
1340	SO[1025]	-7645.5	268	1374	SO[1059]	-8223.5	128	1408	SO[1093]	-8801.5	408
1341	SO[1026]	-7662.5	128	1375	SO[1060]	-8240.5	408	1409	SO[1094]	-8818.5	268
1342	SO[1027]	-7679.5	408	1376	SO[1061]	-8257.5	268	1410	SO[1095]	-8835.5	128
1343	SO[1028]	-7696.5	268	1377	SO[1062]	-8274.5	128	1411	SO[1096]	-8852.5	408
1344	SO[1029]	-7713.5	128	1378	SO[1063]	-8291.5	408	1412	SO[1097]	-8869.5	268
1345	SO[1030]	-7730.5	408	1379	SO[1064]	-8308.5	268	1413	SO[1098]	-8886.5	128
1346	SO[1031]	-7747.5	268	1380	SO[1065]	-8325.5	128	1414	SO[1099]	-8903.5	408
1347	SO[1032]	-7764.5	128	1381	SO[1066]	-8342.5	408	1415	SO[1100]	-8920.5	268
1348	SO[1033]	-7781.5	408	1382	SO[1067]	-8359.5	268	1416	SO[1101]	-8937.5	128
1349	SO[1034]	-7798.5	268	1383	SO[1068]	-8376.5	128	1417	SO[1102]	-8954.5	408
1350	SO[1035]	-7815.5	128	1384	SO[1069]	-8393.5	408	1418	SO[1103]	-8971.5	268
1351	SO[1036]	-7832.5	408	1385	SO[1070]	-8410.5	268	1419	SO[1104]	-8988.5	128
1352	SO[1037]	-7849.5	268	1386	SO[1071]	-8427.5	128	1420	SO[1105]	-9005.5	408
1353	SO[1038]	-7866.5	128	1387	SO[1072]	-8444.5	408	1421	SO[1106]	-9022.5	268
1354	SO[1039]	-7883.5	408	1388	SO[1073]	-8461.5	268	1422	SO[1107]	-9039.5	128
1355	SO[1040]	-7900.5	268	1389	SO[1074]	-8478.5	128	1423	SO[1108]	-9056.5	408
1356	SO[1041]	-7917.5	128	1390	SO[1075]	-8495.5	408	1424	SO[1109]	-9073.5	268
1357	SO[1042]	-7934.5	408	1391	SO[1076]	-8512.5	268	1425	SO[1110]	-9090.5	128
1358	SO[1043]	-7951.5	268	1392	SO[1077]	-8529.5	128	1426	SO[1111]	-9107.5	408
1359	SO[1044]	-7968.5	128	1393	SO[1078]	-8546.5	408	1427	SO[1112]	-9124.5	268
1360	SO[1045]	-7985.5	408	1394	SO[1079]	-8563.5	268	1428	SO[1113]	-9141.5	128

No.	TextName	CX	CY	No.	TextName	CX	CY	No.	TextName	CX	CY
1429	SO[1114]	-9158.5	408	1463	SO[1148]	-9736.5	268	1497	SO[1182]	-10314.5	128
1430	SO[1115]	-9175.5	268	1464	SO[1149]	-9753.5	128	1498	SO[1183]	-10331.5	408
1431	SO[1116]	-9192.5	128	1465	SO[1150]	-9770.5	408	1499	SO[1184]	-10348.5	268
1432	SO[1117]	-9209.5	408	1466	SO[1151]	-9787.5	268	1500	SO[1185]	-10365.5	128
1433	SO[1118]	-9226.5	268	1467	SO[1152]	-9804.5	128	1501	SO[1186]	-10382.5	408
1434	SO[1119]	-9243.5	128	1468	SO[1153]	-9821.5	408	1502	SO[1187]	-10399.5	268
1435	SO[1120]	-9260.5	408	1469	SO[1154]	-9838.5	268	1503	SO[1188]	-10416.5	128
1436	SO[1121]	-9277.5	268	1470	SO[1155]	-9855.5	128	1504	SO[1189]	-10433.5	408
1437	SO[1122]	-9294.5	128	1471	SO[1156]	-9872.5	408	1505	SO[1190]	-10450.5	268
1438	SO[1123]	-9311.5	408	1472	SO[1157]	-9889.5	268	1506	SO[1191]	-10467.5	128
1439	SO[1124]	-9328.5	268	1473	SO[1158]	-9906.5	128	1507	SO[1192]	-10484.5	408
1440	SO[1125]	-9345.5	128	1474	SO[1159]	-9923.5	408	1508	SO[1193]	-10501.5	268
1441	SO[1126]	-9362.5	408	1475	SO[1160]	-9940.5	268	1509	SO[1194]	-10518.5	128
1442	SO[1127]	-9379.5	268	1476	SO[1161]	-9957.5	128	1510	SO[1195]	-10535.5	408
1443	SO[1128]	-9396.5	128	1477	SO[1162]	-9974.5	408	1511	SO[1196]	-10552.5	268
1444	SO[1129]	-9413.5	408	1478	SO[1163]	-9991.5	268	1512	SO[1197]	-10569.5	128
1445	SO[1130]	-9430.5	268	1479	SO[1164]	-10008.5	128	1513	SO[1198]	-10586.5	408
1446	SO[1131]	-9447.5	128	1480	SO[1165]	-10025.5	408	1514	SO[1199]	-10603.5	268
1447	SO[1132]	-9464.5	408	1481	SO[1166]	-10042.5	268	1515	SO[1200]	-10620.5	128
1448	SO[1133]	-9481.5	268	1482	SO[1167]	-10059.5	128	1516	SHIELDING[76]	-10664	428
1449	SO[1134]	-9498.5	128	1483	SO[1168]	-10076.5	408	1517	COM1_T	-10714	428
1450	SO[1135]	-9515.5	408	1484	SO[1169]	-10093.5	268	1518	COM1_T	-10764	428
1451	SO[1136]	-9532.5	268	1485	SO[1170]	-10110.5	128	1519	SHIELDING[77]	-10814	428
1452	SO[1137]	-9549.5	128	1486	SO[1171]	-10127.5	408	1520	DCMPR	-10864	428
1453	SO[1138]	-9566.5	408	1487	SO[1172]	-10144.5	268	1521	DCMPR	-10914	428
1454	SO[1139]	-9583.5	268	1488	SO[1173]	-10161.5	128	1522	OEVR	-11049	328
1455	SO[1140]	-9600.5	128	1489	SO[1174]	-10178.5	408	1523	INVBRR	-11049	408
1456	SO[1141]	-9617.5	408	1490	SO[1175]	-10195.5	268				
1457	SO[1142]	-9634.5	268	1491	SO[1176]	-10212.5	128				
1458	SO[1143]	-9651.5	128	1492	SO[1177]	-10229.5	408				
1459	SO[1144]	-9668.5	408	1493	SO[1178]	-10246.5	268				
1460	SO[1145]	-9685.5	268	1494	SO[1179]	-10263.5	128				
1461	SO[1146]	-9702.5	128	1495	SO[1180]	-10280.5	408				
1462	SO[1147]	-9719.5	408	1496	SO[1181]	-10297.5	268				

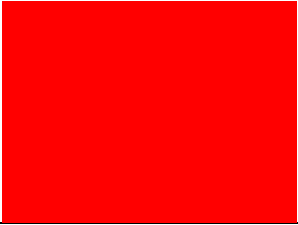
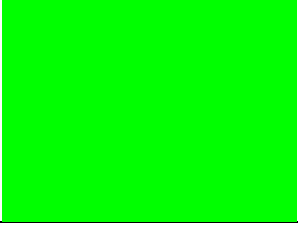
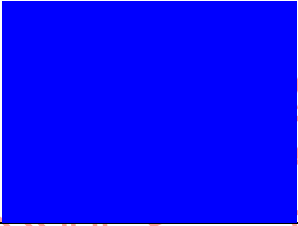
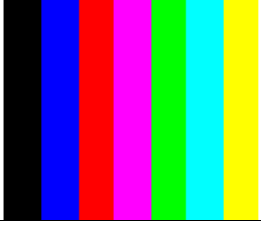
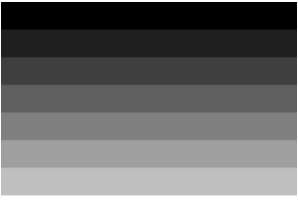
Appendix B: BIST Pattern

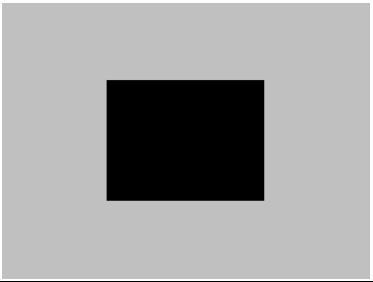
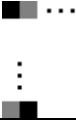
No.	Pattern	Test function Description	Notice
1		1. Color alignment with color filter.	
2		1. Color alignment with color filter.	
3		1. Color alignment with color filter.	
4	Black		
5	White		
6		1. Customer standard test pattern. 2. Color alignment with color filter. 3. Driver scan direction.	
7		1. Customer standard test pattern.	

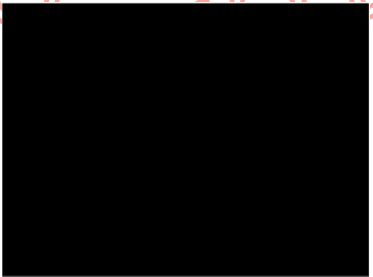
No.	Pattern	Test function Description	Notice
8		1. Customer standard test pattern.	
9		1. Cross talk	
10		1. Chessboard pattern.	
11		1. Black-Gray(128) flicker pattern	
12		Black background and White circle	