



**SPECIFICATION
FOR
LCD MODULE**

**MODULE NO: AFV1024600A02L-7.0N12NTN
REVISION NO: 03**

Customer's Approval:

--

	SIGNATURE	DATE
PREPARED BY		
CHECKED BY		
APPROVED BY		

REVISION RECORD

REV NO.	REV DATE	CONTENTS	REMARKS
V0.1	2013-09-28	First release	Preliminary
V0.2	2013-10-10	Add IC information	Page6
V0.3	2013-10-19	Revise specification	Page4,6,14

CONTENTS

■ GENERAL INFORMATION.....	4
■ ABSOLUTE MAXIMUM RATINGS.....	4
■ ELECTRICAL CHARACTERISTICS.....	4
■ BACKLIGHT CHARACTERISTICS.....	5
■ EXTERNAL DIMENSIONS.....	6
■ ELECTRO-OPTICAL CHARACTERISTICS.....	7
■ INTERFACE DESCRIPTION.....	9
■ MODULE FUNCTION DESCRIPTION.....	10
■ REFERENCE APPLICATION CIRCUIT.....	14
■ RELIABILITY TEST CONDITIONS.....	15
■ INSPECTION CRITERION.....	16

■ GENERAL INFORMATION

Item of general information	Contents	Unit
LCD size	7.0 inch (Digital)	/
LCD type	TFT/TRANSMISSIVE normal white	
View direction	12 o'clock (Gray scale inversion- 6 o'clock)	
Resolution	1024*3(RGB)*600	
Module size (W × H×T)	165.75(W)×105.39(H)×2.8(D)	mm ³
Active area (W×H)	153.6(H)×90.0(V)	mm ²
Pixel pitch (W × H)	0.15(H)×0.15(V)	mm ²
Interface Type	LVDS interface	/
Input voltage	3.3V	V
Module Power consumption	TBD	mw
Backlight Type	18*LED	/

■ ABSOLUTE MAXIMUM RATINGS

Parameter	Symbol	Min	Max	Unit
Power supply voltage	DVDD	-0.5	5	V
Logic Signal Input Level	V _i	-0.5	DVDD+0.3	V
Operating temperature	T _{op}	-20	70	°C
Storage temperature	T _{ST}	-30	80	°C
Humidity	RH	-	90%(Max60 °C)	RH

■ ELECTRICAL CHARACTERISTICS

DC CHARACTERISTICS

Parameter	Symbol	Min	Typ	Max	Unit
Supply Voltage	VDD	3.0	3.3	3.6	V
	VCOM	2.3	2.5	3.6	V
	VGH	16.4	18.4	20.4	V
	VGL	-7.0	-6.0	-5.0	V
	AVDD	7.8	8.8	9.8	V
Current of power supply	IVDD	-	21	35	mA
	IAVDD	-	30	55	mA
	IGH	-	0.5	1.5	mA
	IGL	-	2.5	4.5	mA
Input voltage 'H' level	V _{IH}	0.7DVDD	-	VDD	V
Input voltage 'L' level	V _{IL}	0	-	0.3VDD	V

Note:Be sure to apply DVDD and VGL to the LCD first , then apply VGH.

■ BACKLIGHT CHARACTERISTICS

Item of backlight characteristics	Symbol	Min.	Typ.	Max.	Unit	Condition
Forward voltage	Vf	-	9.6	-	V	Note 1
Current for LED backlight	IL	-	120	-	mA	Note 1
LED life time		20,000	-	-	Hour	Note 2

Note 1: The LED Supply Voltage is defined by the number of LED at Ta=25°C and IL =20mA for each LED.

Note 2: The “LED life time” is defined as the module brightness decrease to 50% original brightness at Ta=25°C and IL =120mA. The LED lifetime could be decreased if operating IL is larger than 120 mA.

EXTERNAL DIMENSIONS

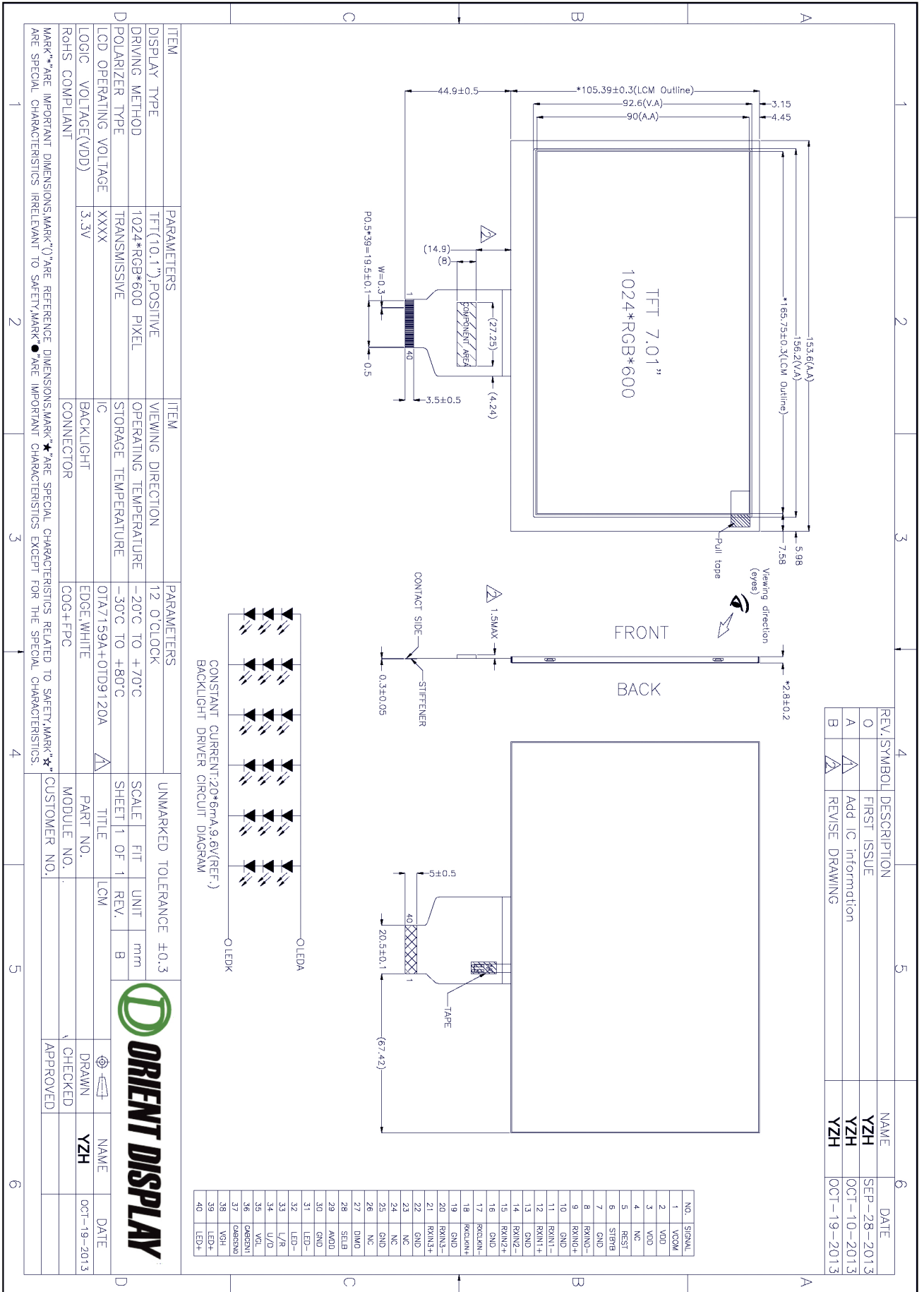

REV./SYMBOL	DESCRIPTION	NAME	DATE
0	FIRST ISSUE	YZH	SEP-28-2013
A	Add IC Information	YZH	OCT-10-2013
B	REVISE DRAWING	YZH	OCT-19-2013

ITEM	PARAMETERS	ITEM	PARAMETERS	UNMARKED TOLERANCE ±0.3
DISPLAY TYPE	TFT(10.1"), POSITIVE	VIEWING DIRECTION	12 O'CLOCK	SCALE
DRIVING METHOD	1024*RGB*600 PIXEL	OPERATING TEMPERATURE	-20°C TO +70°C	FIT
POLARIZER TYPE	TRANSMISSIVE	STORAGE TEMPERATURE	-30°C TO +80°C	UNIT
LCD OPERATING VOLTAGE	XXXX	OTA1759A+OTD9120A		mm
LOGIC VOLTAGE(VDD)	3.3V	EDGE, WHITE		REV.
ROHS COMPLIANT		COG+FPG		B
		CONNECTOR		TITLE
				LCM
				PART NO.
				MODULE NO.
				CUSTOMER NO.
				DRAWN
				CHECKED
				APPROVED
				NAME
				DATE



■ ELECTRO-OPTICAL CHARACTERISTICS

Item of electro-optical characteristics	Symbol	Condition	Min	Typ	Max	Unit	Remark	Note
Response time	Tr+ Tf		–	25	50	ms	Fig.1	4
Contrast ratio	Cr		400	500	–	---	FIG 2.	1
Luminance uniformity	δ WHITE		60	75	–	%	FIG 2.	3
Surface Luminance	Lv		220	250	–	cd/m ²	FIG 2.	2
Viewing angle range	θ	∅ = 90°	60	70	–	deg	FIG 3.	6
		∅ = 270°	55	65	–	deg	FIG 3.	
		∅ = 0°	60	70	–	deg	FIG 3.	
		∅ = 180°	60	70	–	deg	FIG 3.	
CIE (x, y) chromaticity	Red x	θ=0° ∅=0° Ta=25°C	0.586	0.601	0.616	-	FIG 2.	5
	Red y		0.309	0.324	0.339	-		
	Green x		0.291	0.301	0.311	-		
	Green y		0.552	0.567	0.582	-		
	Blue x		0.133	0.143	0.153	-		
	Blue y		0.159	0.174	0.189	-		
	White x		0.294	0.304	0.314	-		
	White y		0.329	0.339	0.349	-		

Note1. Contrast Ratio(CR) is defined mathematically by the following formula. For more information see FIG 2.:

$$\text{Contrast Ratio} = \frac{\text{Average Surface Luminance with all white pixels (P1, P2, P3, P4, P5)}}{\text{Average Surface Luminance with all black pixels (P1, P2, P3, P4, P5)}}$$

Note2. Surface luminance is the LCD surface from the surface with all pixels displaying white. For more information see FIG 2.

$$L_v = \text{Average Surface Luminance with all white pixels (P1, P2, P3, P4, P5)}$$

Note3. The uniformity in surface luminance (δ WHITE) is determined by measuring luminance at each test position 1 through 5, and then dividing the maximum luminance of 5 points luminance by minimum luminance of 5 points luminance. For more information see FIG 2.

$$\delta \text{ WHITE} = \frac{\text{Minimum Surface Luminance with all white pixels (P1, P2, P3, P4, P5)}}{\text{Maximum Surface Luminance with all white pixels (P1, P2, P3, P4, P5)}}$$

Note4. Response time is the time required for the display to transition from White to black(Rise Time, Tr) and from black to white(Decay Time, Tf). For additional information see FIG 1.

Note5. CIE (x, y) chromaticity, The x,y value is determined by screen active area position NO.5 For more information see FIG 2.

Note6. Viewing angle is the angle at which the contrast ratio is greater than 2. For TFT module the contrast ratio is greater than 10. The angles are determined for the horizontal or x axis and the vertical or y axis with respect to the z axis which is normal to the LCD surface. For more information see FIG 3.

Note7. For Viewing angle and response time testing, the testing data is base on Autronic-Melchers's ConoScope. Series Instruments. For contrast ratio, Surface Luminance, Luminance uniformity and CIE, the testing data is base on TOPCON's BM-5 photo detector or compatible.

Note8. For TFT module, Gray scale reverse occurs in the direction of panel viewing angle

FIG.1. The definition of Response Time

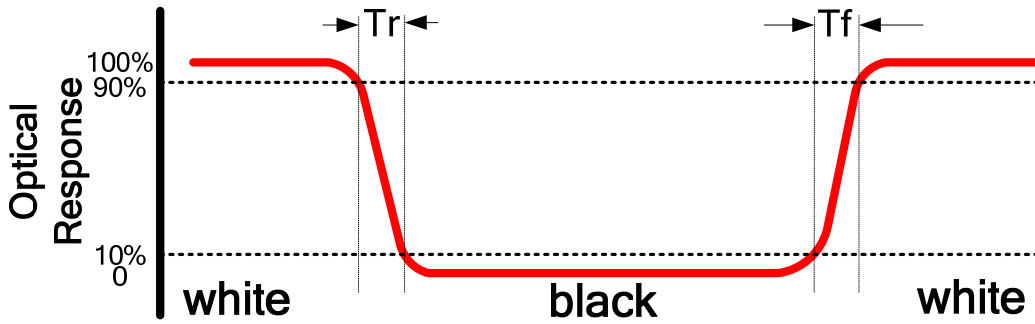

FIG.2. Measuring method for Contrast ratio, surface luminance, Luminance uniformity, CIE (x, y) chromaticity

A : 5 mm
 B : 5 mm
 H, V : Active Area
 Light spot size $\varnothing=5\text{mm}$, 500mm distance from the LCD surface to detector lens
 measurement instrument is TOPCON's luminance meter BM-5

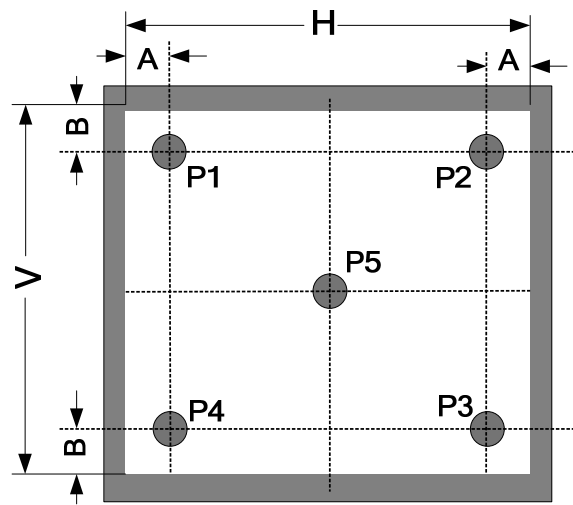
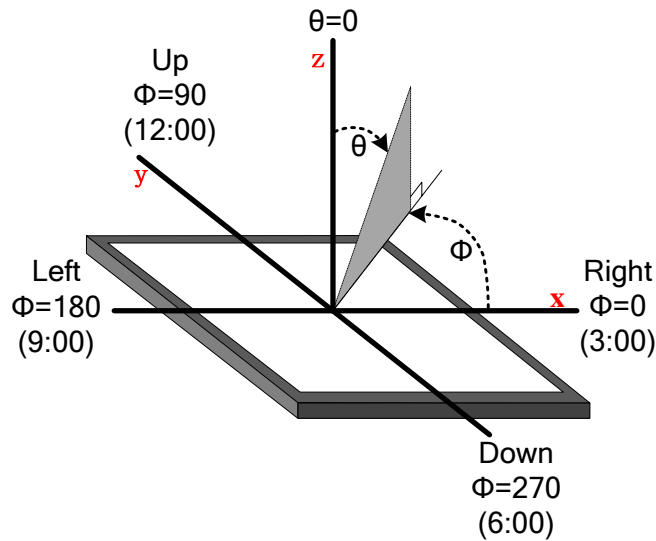

FIG.3. The definition of viewing angle



■ INTERFACE DESCRIPTION

Interface NO.	NAME	I/O or connect to	DESCRIPTION
1	VCOM	P	Common voltage
2-3	VDD	P	Power Voltage for digital circuit
4	GND	-	Not connect
5	REST	I	Global reset pin
6	STBYB	I	Standby mode , normally pull high STBYB="1", normal operation MODE="0", timing control, source driver will turn off,All out put are high-Z
7	GND	P	Power Ground
8	RXIN0-	I	-LVDS differential data input
9	RXIN0+	I	+LVDS differential data input
10	GND	P	Power Ground
11	RXIN1-	I	-LVDS differential data input
12	RXIN1+	I	+LVDS differential data input
13	GND	P	Power Ground
14	RXIN2-	I	-LVDS differential data input
15	RXIN2+	I	+LVDS differential data input
16	GND	P	Power Ground
17	RXCLKIN-	I	-LVDS differential clock input
18	RXCLKIN+	I	+LVDS differential clock input
19	GND	P	Power Ground
20	RXIN3-	I	-LVDS differential data input
21	RXIN3+	I	+LVDS differential data input
22	GND	P	Power Ground
23-24	NC	-	Not connect
25	GND	P	Power Ground
26	NC	-	Not connect
27	DIM0	O	Backlight CABC controller signal output
28	SELB	I	6bit/8bit mode select H:6bit / L:8bit
29	AVDD	P	Power for Analog Circuit
30	GND	P	Power Ground
31-32	LED-	P	LED Cathode
33	L/R	I	Source right or left sequence control.L/R="H"---left to right; L/R="L"—right to left
34	U/D	I	gate up or down scan control. U/D="L"---up to down; U/D="H"---down to up
35	VGL	P	Gate OFF voltage
36	CABCEN1	I	CABC Enable Control Input
37	CABCEN0	I	CABC Enable Control Input
38	VGH	P	Gate ON voltage
39-40	LED+	P	LED Anticathode

MODULE FUNCTION DESCRIPTION

1.Switching Characteristics for LVDS Receiver

Item	Symbol	Min	Typ	Max	Unit	Remark
Differential Input High Threshold	Vth	-	-	100	mV	VCM=1.2V
Differential Input Low Threshold	Vtl	-100	-	-	mV	
Input Current Differential Input Voltage	IIN	-10	-	+10	uA	
	VID	0.1	-	0.6	V	
Common Mode Voltage Offset	VCM	0.7	1.2	1.6	V	

2.Bit LVDS input

2.1 6 bit LVDS input

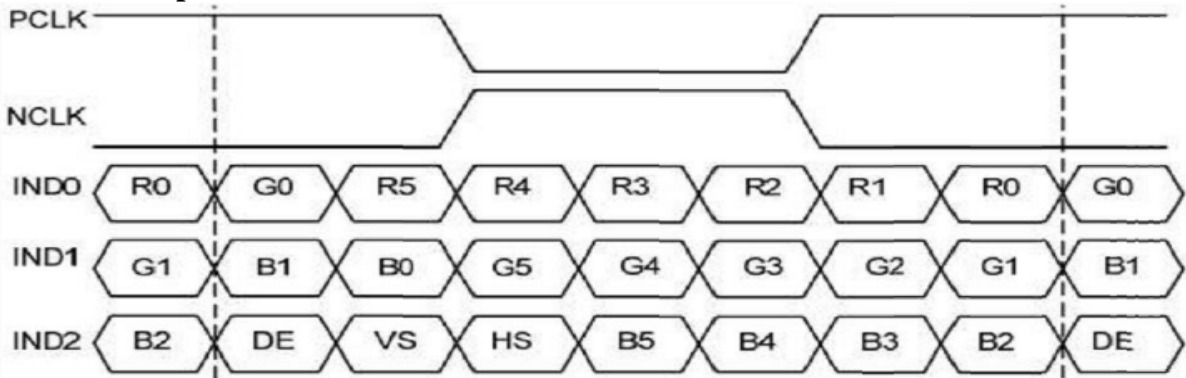

2.2 8 bit LVDS input

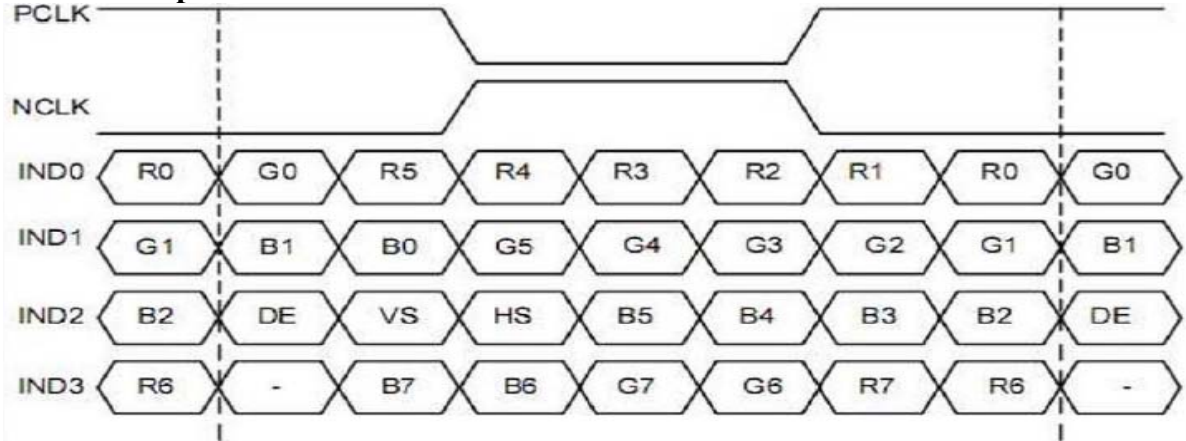

3.DC Electrical Characteristics

LVDS mode (Receiver Differential Input PIND0-PIND3, NIND0-NIND3, PINC, NINC)

Parameter	Symbol	Min	Typ	Max	Unit	Conditions
Differential input high threshold voltage	RxVTH	-	-	0.1	V	RxVCM=1.2V
Differential input low threshold voltage	RxVTL	-0.1	-	-	V	
Input voltage range (singled-end)	RxVIN	0	-	2.4	V	
Differential input common mode voltage	RxVCM	VID / 2	-	2.1 - VID / 2	V	
Differential input voltage	VID	0.2	-	0.6	V	
Differential input leakage current	RVxliz	-10	-	+10	uA	
LVDS Digital Operating Current	Iddlvs	-	TBD	TBD	mA	Fdk =65MHZ, VDD=3.3V
LVDS Digital Standby Current	Istlvs	-	TBD	TBD	uA	Clock & all Functions are stopped

Single end signals

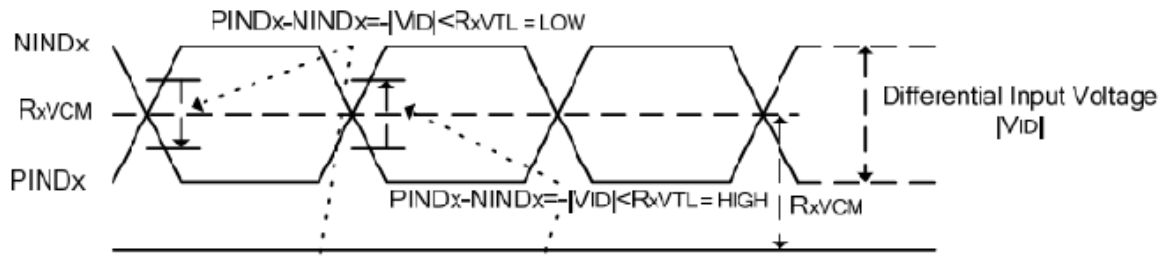

Differential signals

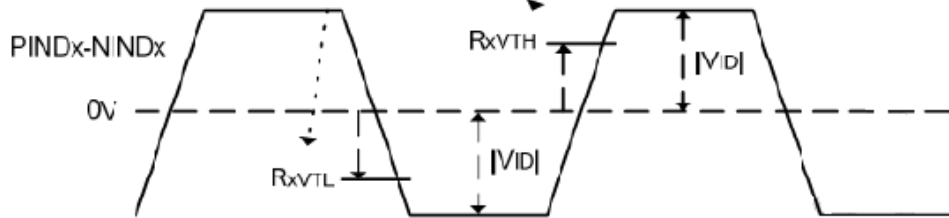

3.AC Electrical Characteristics

LVDS mode

Parameter	Symbol	Min	Typ	Max	Unit	Conditions
Clock frequency	RxFCLK	26.2	-	71	MHz	
Input data skew margin	TRSKM	500	-	-	ps	$ VID = 400mV$
						$RxVCM = 1.2V$
						$RxFCLK = 71MHz$
Clock high time	TLVCH	-	$4/(7 \times RxFCLK)$	-	ns	
Clock low time	TLVCL	-	$3/(7 \times RxFCLK)$	-	ns	
VSD setup time	TenPLL	-	-	150	us	

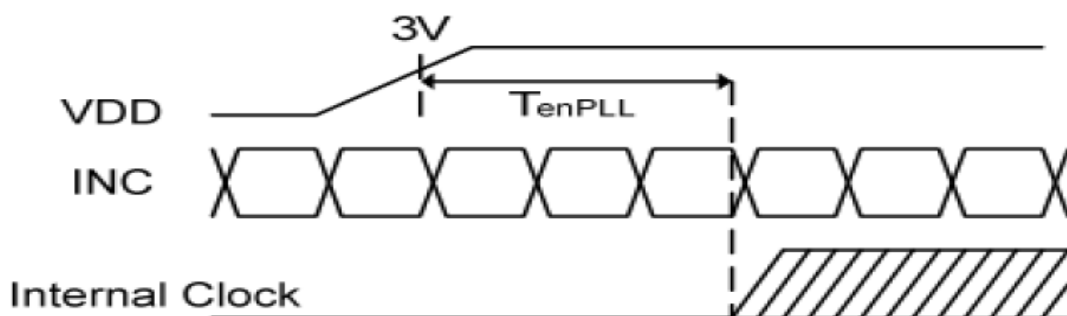
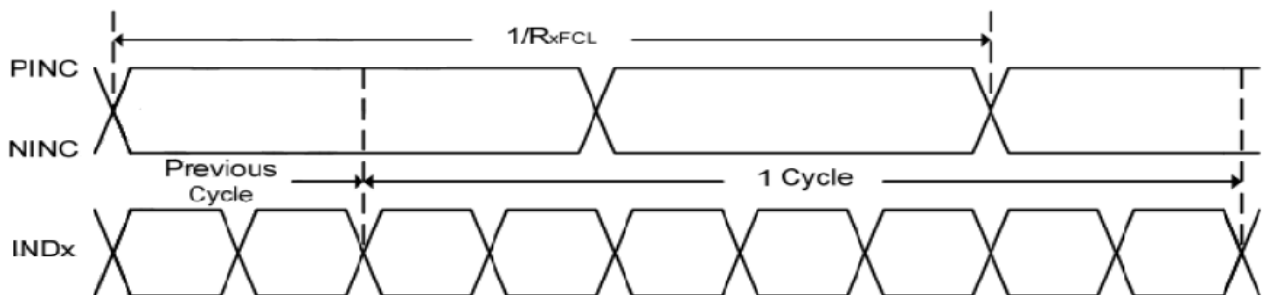

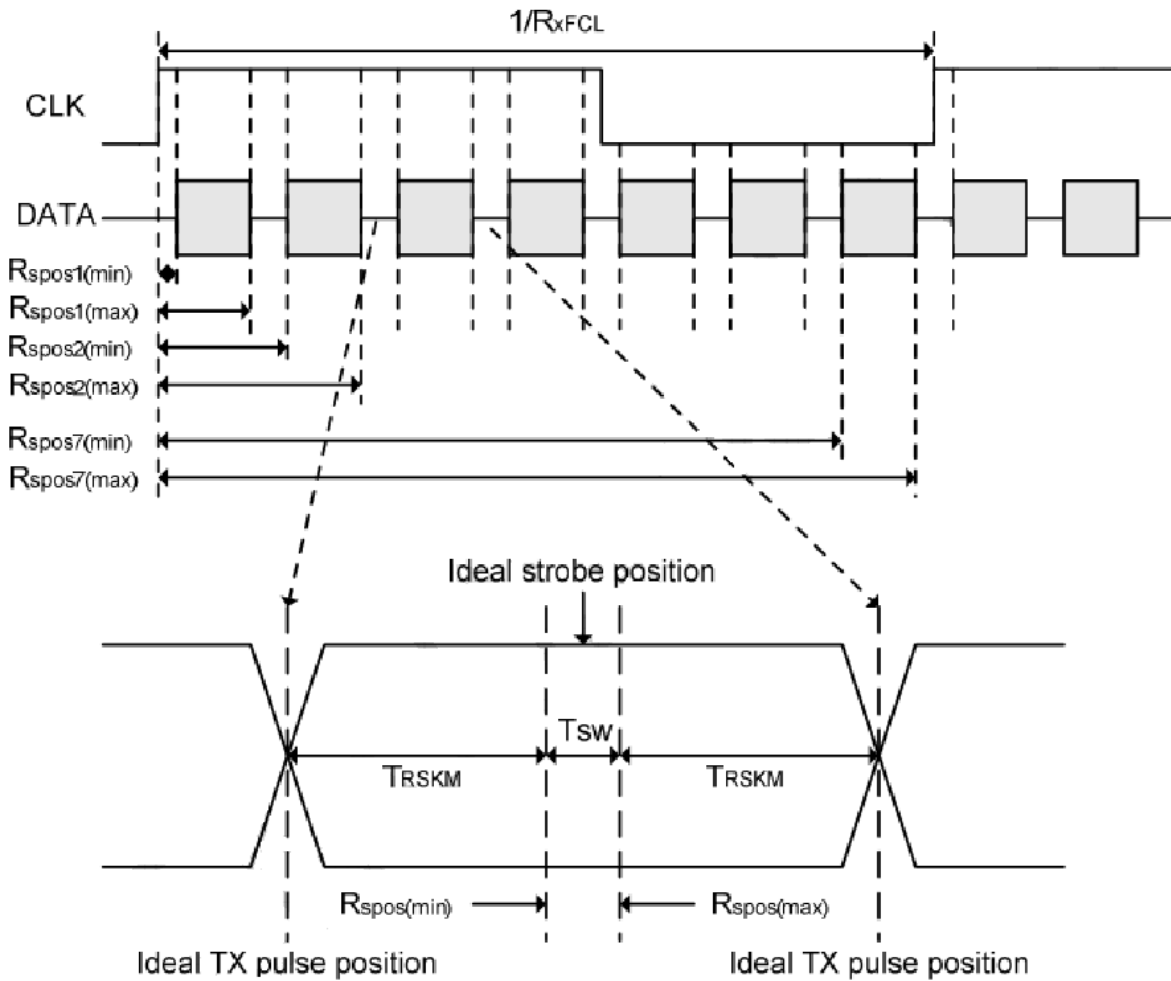

T_{RSKM} : Receiver strobe margin
 R_{SPOS} Receiver strobe position
 T_{SW} : Strobe width (internal data sampling window)

SSC tolerance of LVDS receiver

Symbol	Parameter	Conditions	Min	Typ	Max	Unit
SSCMF	Modulation Freq.	-	23	-	93	KHz
SSCMR	Modulation Rate	LCDS clock=71MHz Center spread	-	-	±3	%

Output timing table

Parameter	Symbol	Min	Typ	Max	Unit	Conditions
DCLK Frequency	Fclk	-	65	71	MHz	VDD=2.3V-3.6V
DCLK Cycle Time	Tclk	14.1	15.4	-	Ns	
DCLK Pulse Duty	Tewh	40	50	60	%	TCLK
Time from HSD to Source Output	Thso	-	64	-	DCLK	
Time from HSD to LD	Thld	-	64	-	DCLK	
Time from HSD to STV	Thstv	-	2	-	DCLK	
Time from HSD to CKV	Thckv	-	20	-	DCLK	
Time from HSD to OEV	Thoev	-	4	-	DCLK	
LD Pulse Width	Twld	-	10	-	DCLK	
CKB Pulse Width	Twckv	-	66	-	DCLK	
CEV Pulse Width	Twoev	-	74	-	DCLK	

4.Power Signal sequence

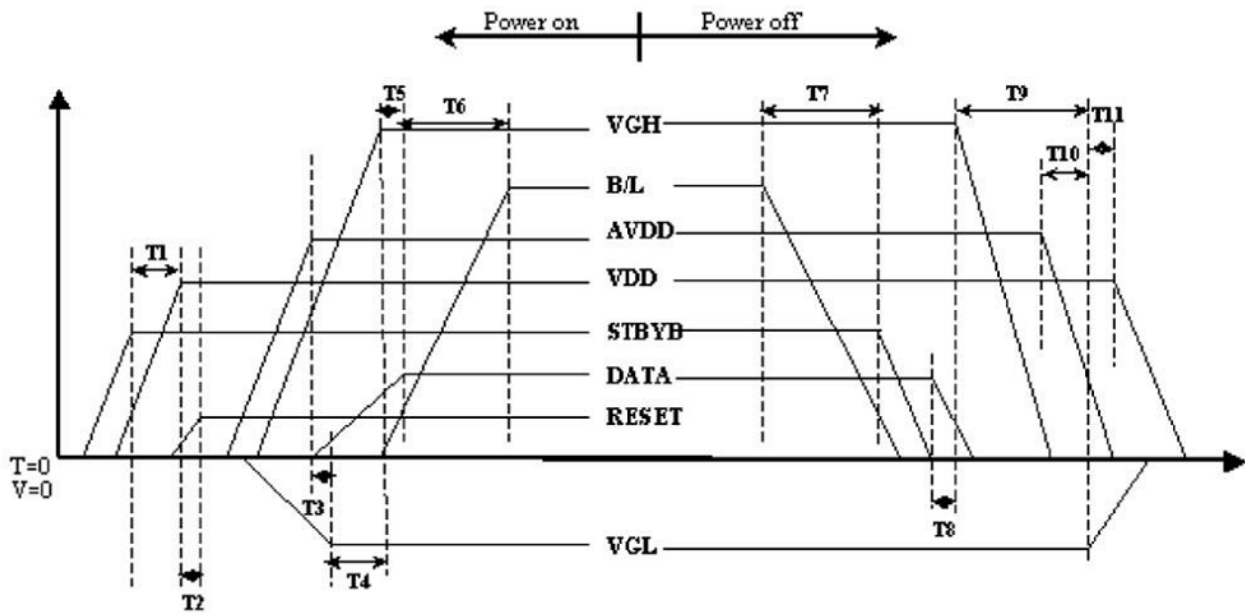

Item	Min	Typ	Max	Unit
T1	0	--	--	ms
T2	50	--	--	ms
T3	5	--	--	ms
T4	10	--	--	ms
T5	20	--	--	ms
T6	50	--	--	ms
T7	20	--	--	ms
T8	10	--	--	ms
T9	20	--	--	ms
T10	10	--	--	ms
T11	20	--	--	ms

■ REFERENCE APPLICATION CIRCUIT

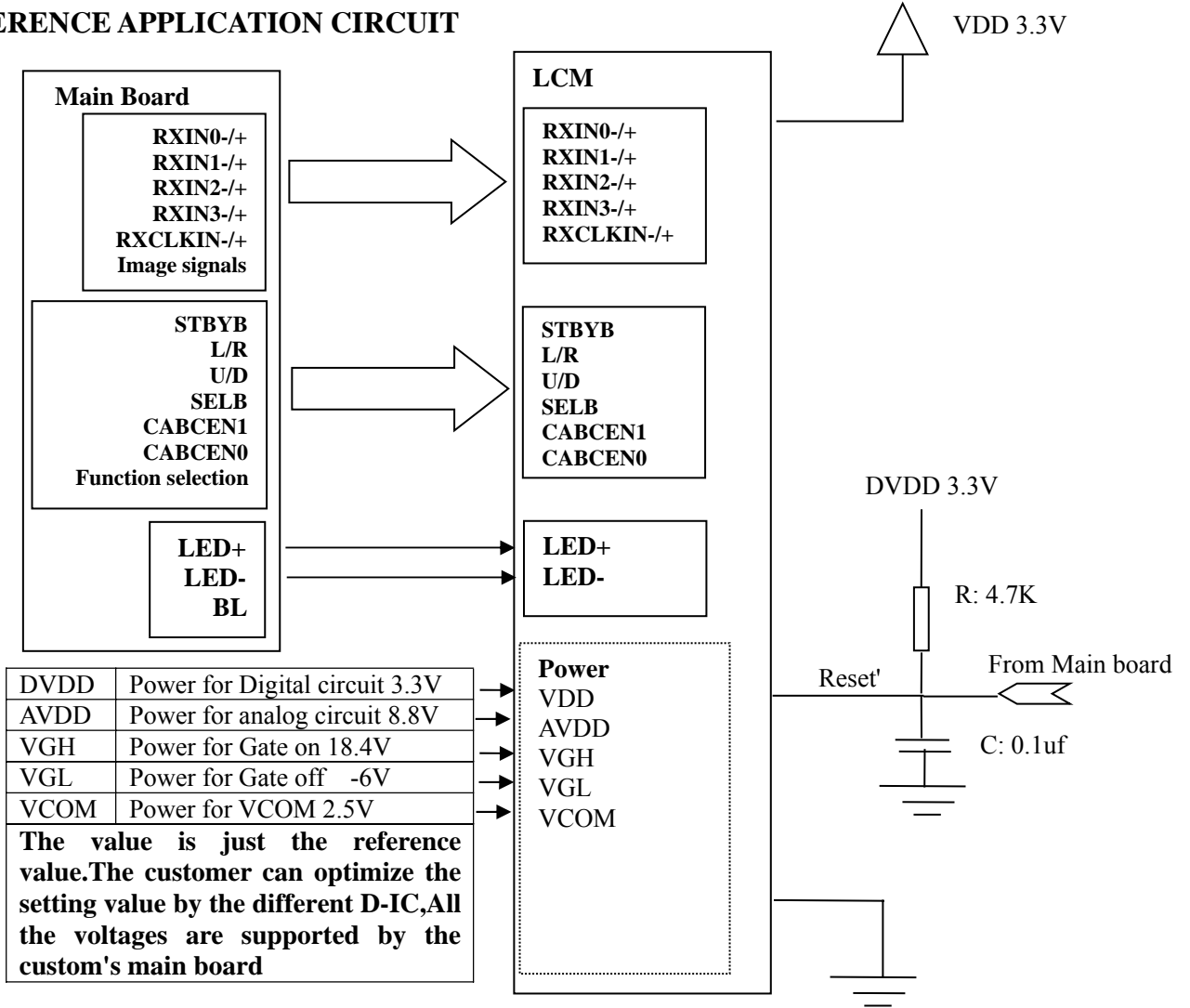

Function Selection:

	1(default)	0		1	0(default)
L/R:			U/D		

L/R,U/D is the selection of the image update direction ,Normally please use the default value.

Note: More information please reference the Spec of OTA7159A

■ RELIABILITY TEST CONDITIONS

No.	Test Item	Test Condition	Inspection after test
1	High Temperature Storage	80±2°C/240 hours	Inspection after 2~4hours storage at room temperature, the sample shall be free from defects: 1.Air bubble in the LCD; 2.Sealleak; 3.Non-display; 4.missing segments; 5.Glass crack; 6.Current Idd is twice higher than initial value.
2	Low Temperature Storage	-30±2°C/240 hours	
3	High Temperature Operating	70±2°C/120 hours	
4	Low Temperature Operating	-20±2°C/120 hours	
5	Temperature Cycle	-20±2°C~25~70±2°C×10cycles (30min.) (5min.) (30min.)	
6	Damp Proof Test	50°C±5°C×90%RH/120 hours	
7	Vibration Test	Frequency: 10Hz~55Hz~10Hz Amplitude: 1.5mm, X, Y, Z direction for total 3hours (Packing condition)	
8	Dropping test	Drop to the ground from 1m height, one time, every side of carton. (Packing condition)	
9	ESD test	Voltage:±8KV R: 330Ω C: 150pF Air discharge, 10time	

Remark:

- 1.The test samples should be applied to only one test item.
- 2.Sample size for each test item is 5~10pcs.
- 3.For Damp Proof Test, Pure water(Resistance>10MΩ) should be used.
- 4.In case of malfunction defect caused by ESD damage, if it would be recovered to normal state after resetting, it would be judged as a good part.
- 5.EL evaluation should be excepted from reliability test with humidity and temperature: Some defects such as black spot/blemish can happen by natural chemical reaction with humidity and Fluorescence EL has.
- 6.Failure Judgment Criterion: Basic Specification, Electrical Characteristic, Mechanical Characteristic, Optical Characteristic.

■ INSPECTION CRITERION

This specification is made to be used as the standard acceptance/rejection criteria for Normal LCM Product.

1 Sample plan

Sampling plan according to GB/T2828.1-2003/ISO 2859-1 : 1999 and ANSI/ASQC Z1.4-1993, normal level 2 and based on:

Major defect: AQL 0.65

Minor defect: AQL 1.5

2. Inspection condition

● Viewing distance for cosmetic inspection is about 30cm with bare eyes, and under an environment of 20~40W light intensity, all directions for inspecting the sample should be within 45° against perpendicular line. (Normal temperature 20~25°C and normal humidity 60±15%RH).

● Driving voltage

The Vop value from which the most optimal contrast can be obtained near the specified Vop in the specification (Within ±0.5V of the typical value at 25°C.).

3. Definition of inspection zone in LCD.

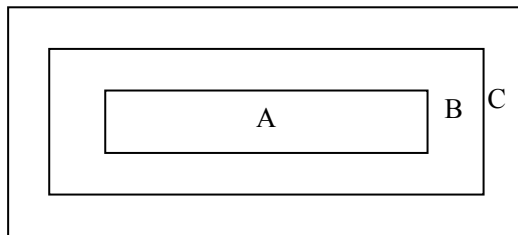

Zone A: character/Digit area

Zone B: viewing area except Zone A (ZoneA+ZoneB=minimum Viewing area)

Zone C: Outside viewing area (invisible area after assembly in customer's product)

Fig.1 Inspection zones in an LCD.

Note: As a general rule, visual defects in Zone C are permissible, when it is no trouble for quality and assembly of customer's product.

4. Inspection Standard

4.1 Major Defect

Item No	Items to be inspected	Inspection Standard	Classification of defects
4.1.1	All functional defects	1) No display 2) Display abnormally 3) Missing vertical, horizontal segment 4) Short circuit 5) Back-light no lighting, flickering and abnormal lighting.	Major
4.1.2	Missing	Missing component	
4.1.3	Outline dimension	Overall outline dimension beyond the drawing is not allowed.	

4.2 Cosmetic Defect

4.2.1 Module Cosmetic Criteria

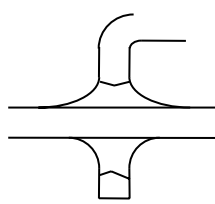
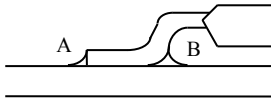
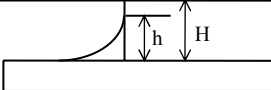
No.	Item	Judgement Criterion	Partition
1	Difference in Spec.	None allowed	Major
2	Pattern peeling	No substrate pattern peeling and floating	Major
3	Soldering defects	No soldering missing No soldering bridge No cold soldering	Major Major Minor
4	Resist flaw on Printed Circuit Boards	visible copper foil ($\varnothing 0.5\text{mm}$ or more) on substrate pattern	Minor
5	Accretion of metallic Foreign matter	No accretion of metallic foreign matters (Not exceed $\varnothing 0.2\text{mm}$)	Minor Minor
6	Stain	No stain to spoil cosmetic badly	Minor
7	Plate discoloring	No plate fading, rusting and discoloring	Minor
8	Solder amount	a. Soldering side of PCB Solder to form a 'Filet' all around the lead. Solder should not hide the lead form perfectly. (too much) b. Components side (In case of 'Through Hole PCB')  Solder to reach the Components side of PCB.	Minor
	2. Flat packages	Either 'Toe' (A) or 'Seal' (B) of the lead to be covered by 'Filet'.  Lead form to be assume over solder.	Minor
	3. Chips	$(3/2) H \geq h \geq (1/2) H$ 	Minor

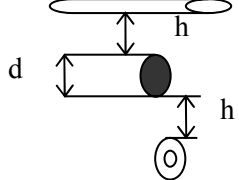
9	Solder ball/Solder splash	<p>a. The spacing between solder ball and the conductor or solder pad $h \geq 0.13\text{mm}$. The diameter of solder ball $d \leq 0.15\text{mm}$.</p> <p>b. The quantity of solder balls or solder Splashes isn't beyond 5 in 600mm^2.</p> <p>c. Solder balls/Solder splashes do not violate minimum electrical clearance.</p> <p>d. Solder balls/Solder splashes must be entrapped/encapsulated Or attached to the metal surface.</p> <p>NOTE: Entrapped/encapsulated/attached is intended to mean that normal service environment of the product will not cause a solder ball to become dislodged.</p>		Minor
				Minor
				Major
				Minor

4.2.2Cosmetic Criteria (Non-Operating)

No.	Defect	Judgment Criterion	Partition										
1	Spots	In accordance with <i>Screen Cosmetic Criteria (Operating) No.1.</i>	Minor										
2	Lines	In accordance with <i>Screen Cosmetic Criteria (Operating) No.2.</i>	Minor										
3	Bubbles in polarizer	<table border="1" style="width: 100%; border-collapse: collapse;"> <thead> <tr> <th>Size : d mm</th> <th>Acceptable Qty in active area</th> </tr> </thead> <tbody> <tr> <td style="text-align: center;">$d \leq 0.3$</td> <td style="text-align: center;">Disregard</td> </tr> <tr> <td style="text-align: center;">$0.3 < d \leq 1.0$</td> <td style="text-align: center;">3</td> </tr> <tr> <td style="text-align: center;">$1.0 < d \leq 1.5$</td> <td style="text-align: center;">1</td> </tr> <tr> <td style="text-align: center;">$1.5 < d$</td> <td style="text-align: center;">0</td> </tr> </tbody> </table>	Size : d mm	Acceptable Qty in active area	$d \leq 0.3$	Disregard	$0.3 < d \leq 1.0$	3	$1.0 < d \leq 1.5$	1	$1.5 < d$	0	Minor
Size : d mm	Acceptable Qty in active area												
$d \leq 0.3$	Disregard												
$0.3 < d \leq 1.0$	3												
$1.0 < d \leq 1.5$	1												
$1.5 < d$	0												
4	Scratch	In accordance with spots and lines operating cosmetic criteria. When the light reflects on the panel surface, the scratches are not to be remarkable.	Minor										
5	Allowable density	Above defects should be separated more than 30mm each other.	Minor										
6	Coloration	Not to be noticeable coloration in the viewing area of the LCD panels. Back-lit type should be judged with back-lit on state only.	Minor										
7	Contamination	Not to be noticeable.	Minor										

4.2.3 Cosmetic Criteria (Operating)

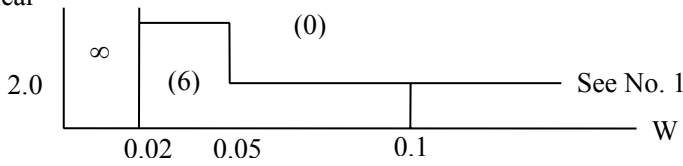
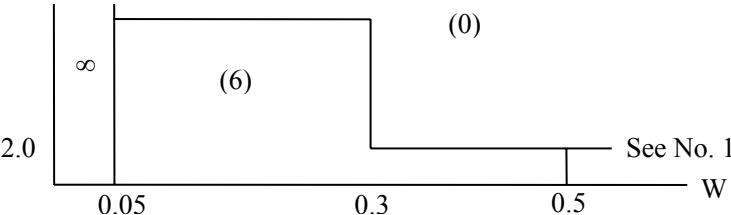
No.	Defect	Judgment Criterion	Partition																																												
1	Spots	<p>A) Clear</p> <table border="1" data-bbox="443 376 1278 707"> <thead> <tr> <th>Lcd size</th> <th>Size : d mm</th> <th>Acceptable Qty in active area</th> </tr> </thead> <tbody> <tr> <td rowspan="4">Lcd size ≤ 8.0'</td> <td>d ≤ 0.1</td> <td>Disregard</td> </tr> <tr> <td>0.1 < d ≤ 0.2</td> <td>6</td> </tr> <tr> <td>0.2 < d ≤ 0.3</td> <td>2</td> </tr> <tr> <td>0.3 < d</td> <td>0</td> </tr> <tr> <td rowspan="4">Lcd size > 8.0'</td> <td>d ≤ 0.1</td> <td>Disregard</td> </tr> <tr> <td>0.1 < d ≤ 0.3</td> <td>10</td> </tr> <tr> <td>0.3 < d ≤ 0.5</td> <td>5</td> </tr> <tr> <td>0.5 < d</td> <td>0</td> </tr> </tbody> </table> <p>Note : Including pin holes and defective dots which must be within one pixel size; Total defective point shall not exceed 6 pcs no more than 8 inch LCD and 10PCS for more than 8 inch LCD.</p> <p>B) Unclear</p> <table border="1" data-bbox="443 898 1278 1283"> <thead> <tr> <th>Lcd size</th> <th>Size : d mm</th> <th>Acceptable Qty in active area</th> </tr> </thead> <tbody> <tr> <td rowspan="4">Lcd size ≤ 8.0'</td> <td>d ≤ 0.2</td> <td>Disregard</td> </tr> <tr> <td>0.2 < d ≤ 0.5</td> <td>6</td> </tr> <tr> <td>0.5 < d ≤ 0.7</td> <td>2</td> </tr> <tr> <td>0.7 < d</td> <td>0</td> </tr> <tr> <td rowspan="5">Lcd size > 8.0'</td> <td>d ≤ 0.2</td> <td>Disregard</td> </tr> <tr> <td>0.2 < d ≤ 0.5</td> <td>10</td> </tr> <tr> <td>0.5 < d ≤ 0.7</td> <td>3</td> </tr> <tr> <td>0.7 < d ≤ 1.0</td> <td>1</td> </tr> <tr> <td>1.0 < d</td> <td>0</td> </tr> </tbody> </table> <p>Note : Total defective point shall not exceed 6 pcs for no more than 8 inch LCD and 10PCS for more than 8 inch LCD.</p>	Lcd size	Size : d mm	Acceptable Qty in active area	Lcd size ≤ 8.0'	d ≤ 0.1	Disregard	0.1 < d ≤ 0.2	6	0.2 < d ≤ 0.3	2	0.3 < d	0	Lcd size > 8.0'	d ≤ 0.1	Disregard	0.1 < d ≤ 0.3	10	0.3 < d ≤ 0.5	5	0.5 < d	0	Lcd size	Size : d mm	Acceptable Qty in active area	Lcd size ≤ 8.0'	d ≤ 0.2	Disregard	0.2 < d ≤ 0.5	6	0.5 < d ≤ 0.7	2	0.7 < d	0	Lcd size > 8.0'	d ≤ 0.2	Disregard	0.2 < d ≤ 0.5	10	0.5 < d ≤ 0.7	3	0.7 < d ≤ 1.0	1	1.0 < d	0	Minor
Lcd size	Size : d mm	Acceptable Qty in active area																																													
Lcd size ≤ 8.0'	d ≤ 0.1	Disregard																																													
	0.1 < d ≤ 0.2	6																																													
	0.2 < d ≤ 0.3	2																																													
	0.3 < d	0																																													
Lcd size > 8.0'	d ≤ 0.1	Disregard																																													
	0.1 < d ≤ 0.3	10																																													
	0.3 < d ≤ 0.5	5																																													
	0.5 < d	0																																													
Lcd size	Size : d mm	Acceptable Qty in active area																																													
Lcd size ≤ 8.0'	d ≤ 0.2	Disregard																																													
	0.2 < d ≤ 0.5	6																																													
	0.5 < d ≤ 0.7	2																																													
	0.7 < d	0																																													
Lcd size > 8.0'	d ≤ 0.2	Disregard																																													
	0.2 < d ≤ 0.5	10																																													
	0.5 < d ≤ 0.7	3																																													
	0.7 < d ≤ 1.0	1																																													
	1.0 < d	0																																													
2	Lines	<p>A) Clear</p>  <p>Note : () - Acceptable Qty in active area L - Length (mm) W - Width (mm) ∞ - Disregard</p> <p>B) Unclear</p>  <p>'Clear' = The shade and size are not changed by V_{op}. 'Unclear' = The shade and size are changed by V_{op}.</p>	Minor																																												

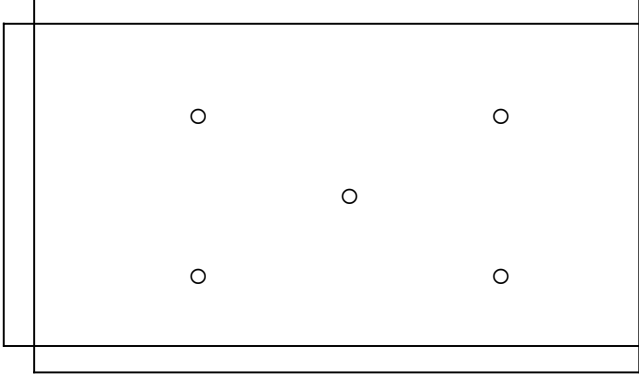
3	Rubbing line	Not to be noticeable.	Minor
4	Allowable density	Above defects should be separated more than 10mm each other.	Minor
5	Rainbow	Not to be noticeable.	Minor
6	Dot size	To be 95% ~ 105% of the dot size (Typ.) in drawing. Partial defects of each dot (ex. pin-hole) should be treated as 'Spot'. (see <i>Screen Cosmetic Criteria (Operating) No.1</i>)	Minor
7	Uneven brightness (only back-lit type module)	<p>Uneven brightness must be $B_{MAX} / B_{MIN} \leq 2$</p> <ul style="list-style-type: none"> - B_{MAX} : Max. value by measure in 5 points - B_{MIN} : Min. value by measure in 5 points <p>Divide active area into 4 vertically and horizontally. Measure 5 points shown in the following figure.</p>  <p style="text-align: center;">○ : Measuring points</p>	Minor

Note :

- (1) Size : $d = (\text{long length} + \text{short length}) / 2$
- (2) The limit samples for each item have priority.
- (3) Complex defects are defined item by item, but if the numbers of defects are defined in above table, the total number should not exceed 10.
- (4) In case of 'concentration', even the spots or the lines of 'disregarded' size should not allowed. Following three situations should be treated as 'concentration'.
 - 7 or over defects in circle of $\varnothing 5\text{mm}$.
 - 10 or over defects in circle of $\varnothing 10\text{mm}$.
 - 20 or over defects in circle of $\varnothing 20\text{mm}$.