



**SPECIFICATION
FOR
LCD MODULE**

**MODULE NO: AFE800480I-6.5N-9292A-T
REVISION NO: A01**

Customer's Approval:

--

	SIGNATURE	DATE
PREPARED BY (RD ENGINEER)		
CHECKED BY		
APPROVED BY		

DOCUMENT REVISION HISTORY

Sample Version	Doc. Version	DATE	DESCRIPTION	CHECKED BY
01	A	2012-02-03	First Release.	

CONTENTS

List	Description	Page No.
1	GENERAL DESCRIPTION	4
2	MECHANICAL SPECIFICATIONS	4
3	BLOCK DIAGRAM	5
4	DIMENSIONAL OUTLINE	6
5	PIN DESCRIPTION	7
6	TIMING CHARACTERISTICS	10
7	ELECTRICAL CHARACTERISTICS	10
8	AC CHARACTERISTICS	12
9	OPTICAL CHARACTERISTICS	15
10	PACKAGE	17
11	RELIABILITY	18
12	SPECIFICATION OF QUALITY ASSURANCE	19
13	GENERAL PRECAUTIONS	28

1. GENERAL DESCRIPTION:

Display & LCD Type:800* (RGB) *480,TFT-Panel

Viewing Direction: 6 O' clock

Backlight Type: White LED

2. MECHANICAL SPECIFICATIONS:

ITEM	SPECIFICATION	UNIT
DISPLAY SIZE	6.5	inch
OUTLINE DIMENSIONS	155.2*89.4*6.9	mm
DISPLAY MODE	Normally White	-
INTERFACE TYPE	RGB	-

***See attached drawing for details.**

3.BLOCK DIAGRAM:

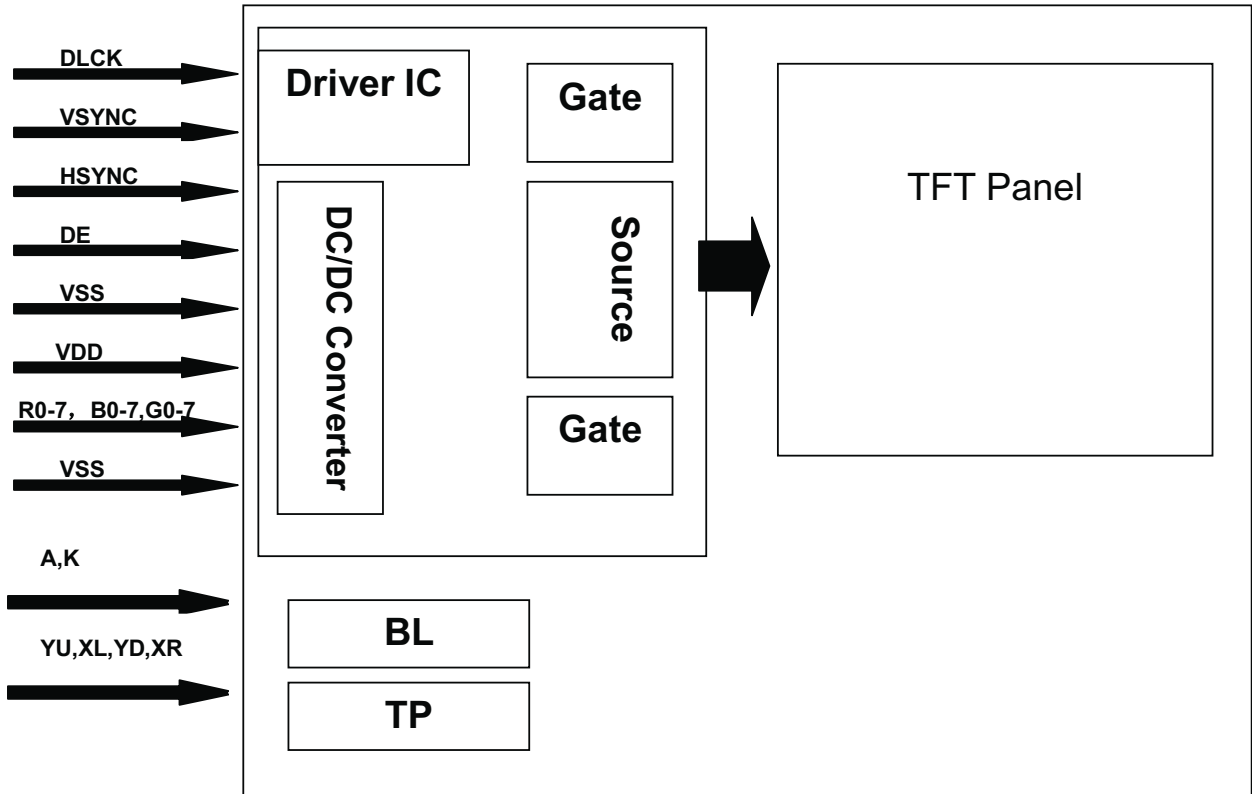

5. PIN DESCRIPTION:

FPC Connector is used for module electronics interface. The recommended model is FH12A-50S-0.5SH manufactured by Hirose.

Pin No.	Symbol	I/O	Function	Remark
1	V_{LED+}	P	Power for LED backlight (Anode)	
2	V_{LED+}	P	Power for LED backlight (Anode)	
3	V_{LED-}	P	Power for LED backlight (Cathode)	
4	V_{LED-}	P	Power for LED backlight (Cathode)	
5	GND	P	Power ground	
6	V_{COM}	I	Common voltage	
7	DV_{DD}	P	Power for Digital Circuit	
8	MODE	I	DE/SYNC mode select	Note 1
9	DE	I	Data Input Enable	
10	VS	I	Vertical Sync Input	
11	HS	I	Horizontal Sync Input	
12	B7	I	Blue data (MSB)	
13	B6	I	Blue data	
14	B5	I	Blue data	
15	B4	I	Blue data	
16	B3	I	Blue data	

25	G2	I	Green data	
26	G1	I	Green data	
27	G0	I	Green data (LSB)	
28	R7	I	Red data (MSB)	
29	R6	I	Red data	
30	R5	I	Red data	
31	R4	I	Red data	
32	R3	I	Red data	Note 1
33	R2	I	Red data	
34	R1	I	Red data	
35	R0	I	Red data (LSB)	
36	GND	P	Power Ground	
37	DCLK	I	Sample Clock	
38	GND	P	Power Ground	
39	L/R	I	Left/Right Selection	
40	U/D	I	Up/Down Selection	
41	V _{OH}	P	Gate ON Voltage	
42	V _{OT}	P	Gate OFF Voltage	Note 2
43	AV _{DD}	P	Power for Analog Circuit	Note 2
44	RESET	I	Global reset pin	
45	NC	-	No Connection	
46	V _{COM}	I	Common Voltage	
47	DITHB	I	Dithering function	
48	GND	P	Power Ground	
49	NC	-	No Connection	
50	NC	-	No Connection	

I: Input, O: Output, P: Power

Note 1: DE/SYNC model select. Normally pull high.

When select DE mode, MODE = "1", VS and HS must pull high.

When select SYNC model, MODE = "0", DE must be grounded.

Note 2: When input 18 bits RGB data, the two low bits or R, G and B data must be grounded.

Note 3: Data shall be latched at the falling edge of DCLK.

TOUCH PANEL PIN

P1	YU	I	Touch Panel PIN
P2	XR	I	Touch Panel PIN
P3	YD	I	Touch Panel PIN
P4	XL	I	Touch Panel PIN

Note:

Note1: ADJ adjust brightness to control Pin,Pulse duty the bigger the brighte

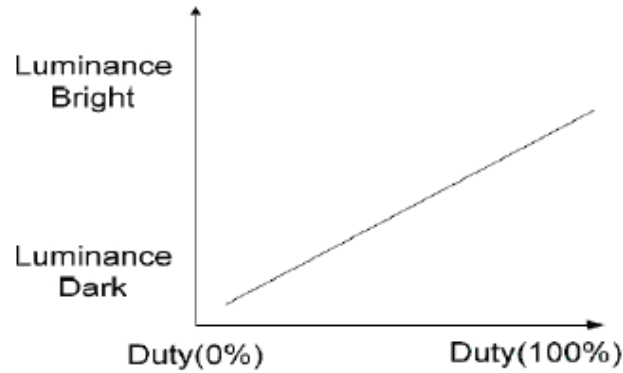

Note 2: ADJ signal=0~3.3V;Operating frequency:100~300Hz.

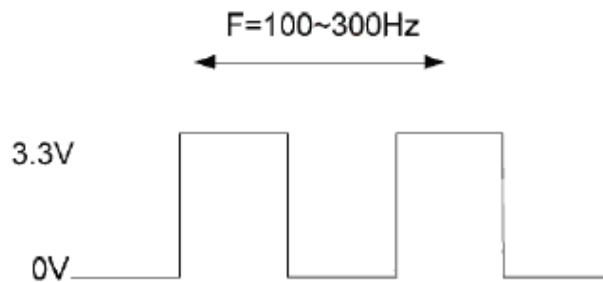

Note 3: DE Mode: Mode="H", HS floating and VS floating.
HV Mode: Mode="L" and DE floating.

Note 4: Selection of scanning mode

Setting of scan control input		Scanning direction
U/D	L/R	
GND	V _{CC}	Up to down, left to right
V _{CC}	GND	Down to up, right to left
GND	GND	Up to down, right to left
V _{CC}	V _{CC}	Down to up, left to right

6. MAXIMUM ABSOLUTE LIMIT:

Item	Symbol	Value	Unit
Power supply voltage for logic	V_{DD}	3.0~5.0	V
Input voltage	V_{in}	$V_{DD}+0.3$	V
Operating temperature	T_{opr}	-20 to 70	°C
Storage temperature	T_{stg}	-30 to 80	°C

Note: Note1: Absolute maximum rating is the limit value beyond which the IC may be broken.

They do not assure operations.

Note2: Background color changes slightly depending on ambient temperature. This Phenomenon is reversible.

$T_a \leq 70^\circ\text{C}$: 75%RH max

$T_a > 70^\circ\text{C}$: absolute humidity must be lower than the humidity of 75%RH at 70°C

Note3: T_a at -30°C will be <48hrs, at 80°C will be <120hrs

7. ELECTRICAL CHARACTERISTICS

7-1 DC Characteristics ($V_{DD}=3.3\text{V}, T_a=25^\circ\text{C}$)

Item	Symbol	Min	Type	Max	Unit	Test condition
Operating voltage	V_{DD}	3.1	3.3	3.5	V	-
Supply current	I_{DD}	-	TBD	-	mA	$V_{DD}=3.3\text{V}, T_a=25^\circ\text{C}$
Input voltage	V_{IH}	$0.7V_{DD}$	-	V_{DD}	V	-
	V_{IL}	0	-	$0.3V_{DD}$	V	
Input leakage current	I_{IL}	-	TBD	-	μA	$V_{IN}=V_{DD}$ or V_{SS}

Note: Voltage greater than above may damage the module.

All voltages are specified relative to $V_{SS}=0\text{V}$.

7-2 Backlight Electrical-optical Characteristics

1. Stander Lamp Styles (Edge Lighting Type):

The LED chips are distributed over the edge light area of the illumination unit, which gives the less power consumption:

2. The Main Advantages of the LED Backlight are as following:

2.1 The brightness of the backlight can simply be adjusted by a resistor or a potentiometer.

3. Data About LED Backlight:

Item	Symbol	MIN	TYP	MAX	UNIT	Test Condition	Note
Supply Voltage	Vf	-	9.3	-	V	If=160mA	-
Supply Current	If	-	160	-	mA	-	-
Reverse Voltage	Vr	-	-	5	V	-	-
Power dissipation	Pd	-	1500	-	mW	-	-
Luminous Intensity for LCM	-	250	320	-	Cd/m ²	If=160mA	-
Uniformity for LCM	-	70	75	-	%	If=160mA	-
Backlight Color	White						

NOTE:

1. Uniformity = Min/Max * 100%
2. LED life time defined as follows:
The final brightness is at 70% of original brightness;
Measured Method: (X*Y: Light Area);

7-3. Touch screen panel specifications:

Item	Symbol	Min.	Type.	Max.	unit	Remark
Transparency	-	-	82	-	%	JIS K-7105
Haze	-	-	1	-	%	JIS K-7105
Hardness Of Surface	-	-	3	-	H	500g/45°
FPC Peeling Strength	-	5		-	N	Upward 90°
FPC Bending	-	-	3	-	cycle	R=1.0, 90°
Input Force	-	-		80	gf	-
Rated Voltage	V touch			7	V	DC
X-axis Resistance	Rx	350		950		FPC PIN
X-axis Resistance	Ry	100		450		
Linearity	-	-	±1.5	±2.0	%	-
Chattering	-	-	-	20	ms	-
Insulation Resistance	Ri	10	-	-	MΩ	-
Notes Life	-	1,00,000	-	-	Times	-
Input Life	-	1,000,000	-	-	Times	-

8. AC CHARACTERISTICS ($V_{DD}=3.3V$, $T_A=25^{\circ}C$)

8.1 Input Signal Characteristics:

Item	Symbol	Values			Unit	Remark
		Min	Typ	Max		
HS setup time	T_{hst}	8	-	-	ns	
HS hold time	T_{hhd}	8	-	-	ns	
VS setup time	T_{vst}	8	-	-	ns	
VS hold time	T_{vhd}	8	-	-	ns	
Data setup time	T_{dsu}	8	-	-	ns	
Data hold time	T_{dhd}	8	-	-	ns	
DE setup time	T_{esu}	8	-	-	ns	
DE hold time	T_{ehd}	8	-	-	ns	
DV_{DD} Power On Slew Rate	T_{POR}	-	-	20	ms	From 0 to 90% DV_{DD}
RESET Pulse width	T_{Rst}	1	-	-	ms	
DCLK cycle time	T_{coh}	20	-	-	ns	
DCLK pulse duty	T_{cwh}	40	50	60	%	

Item	Symbol	Values			Unit	Remark
		Min	Typ	Max		
Horizontal Display Area	thd	-	800	-	DCLK	
DCLK Frequency	fclk	26.4	33.3	46.8	MHz	
One Horizontal Line	th	862	1056	1200	DCLK	
HS pulse width	thpw	1	-	40	DCLK	
HS Blanking	thb	46	46	46	DCLK	
HS Front Porch	thfp	16	210	354	DCLK	

Item	Symbol	Values			Unit	Remark
		Min	Typ	Max		
Vertical Display Area	twd	-	480	-	TH	
VS period time	T_v	510	525	650	TH	
VS pulse width	tvpw	1	-	20	TH	
VS Blanking	tvb	23	23	23	TH	
Data Front Porch	tvfp	7	22	147	TH	

8.2 Clock and Data Input Waveform:

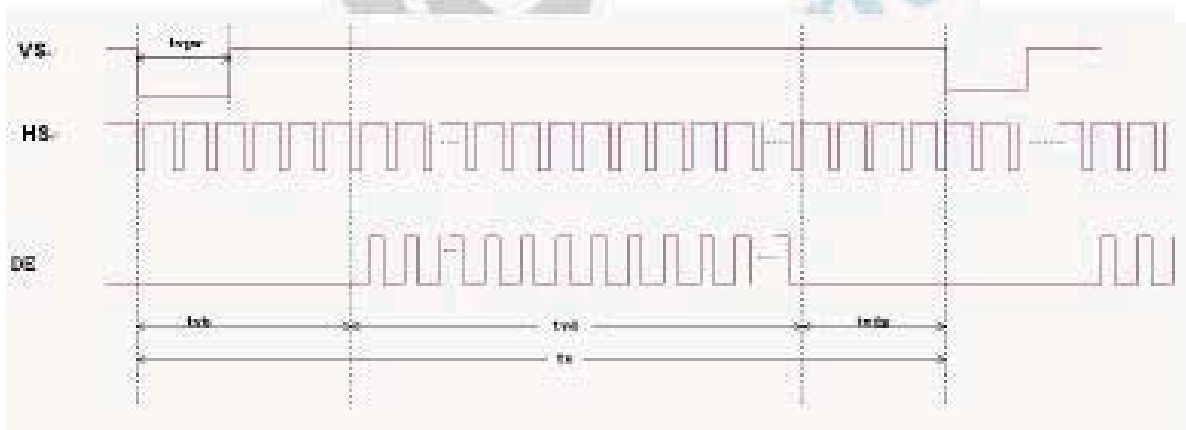

8.3 Power Sequence

1. Power on:

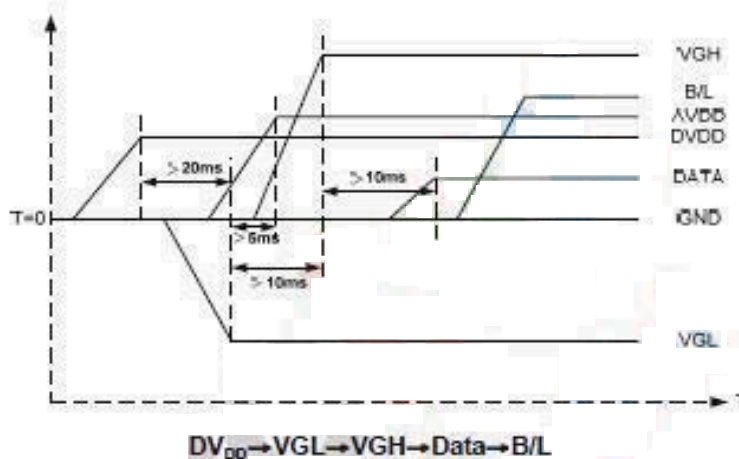

2. Power off:

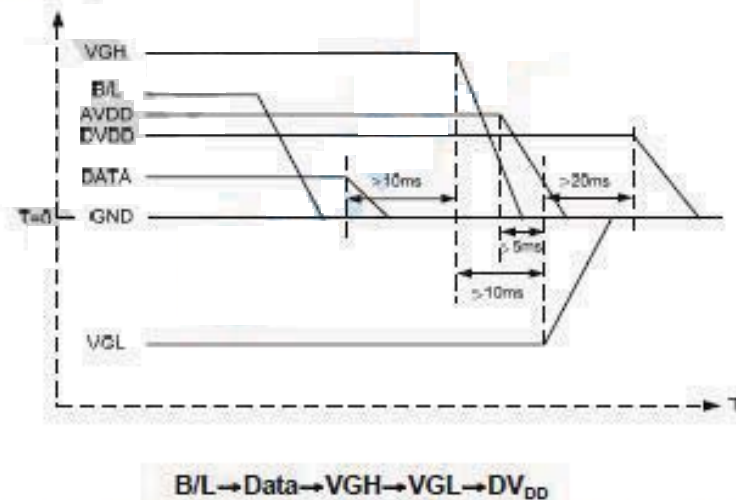

Note: Data include DCLK,POL,OEV,CKV,STVU,STVD,STHL,STHR,LD,R0~R5,G0~G5,B0~B5

Note :

- (1) The supply voltage of the external system for the module input should be the same as the definition of V_{DD} .
- (2) Apply the lamp voltage within the LCD operation range. When the back-light turns on before the LCD operation or the LCD turns off before the back-light turns off, the display may momentarily become white.
- (3) In case of $V_{DD} = \text{off level}$, please keep the level of input signal on the low or keep a high impedance.
- (4) TP4 should be measured after the module has been fully discharged between power off and on period.
- (5) Interface signal shall not be kept at high impedance when the power is on.

9. OPTICAL CHARACTERISTICS:

No.	ITEM		Symbol	Conditions	Specification			Unit	Note
					Min	Typ	Max		
1	Response Time		Tr+Tf	25°C	-	15	-	Ms	(1)(2)
2	Transmittance (With PL)		T(%)	-	-	7.1	-	-	-
3	Contrast Rate		Cr	$\theta=0$, Normal viewing angle	-	500	-	-	(1)(3)
4	Viewing Angle	Hor.	θR	CR>10	-	70	-	Deg	-
			θL		-	70	-		
		Ver.	$\theta+$		-	50	-		
			$\theta-$		-	70	-		

Measure Conditions:

1. Measure surrounding : dark room;
2. Ambient temperature: $25\pm 2^\circ\text{C}$;
3. 30min.warm-up time.

Note Definition:

Note(1)Viewing angle range:

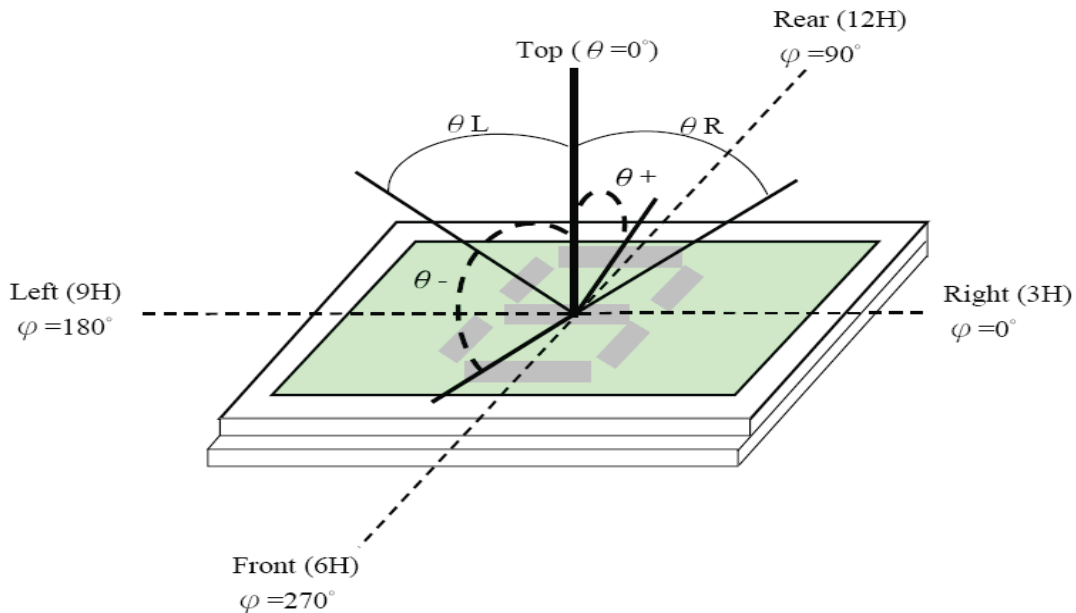

Note(2) Response Time:

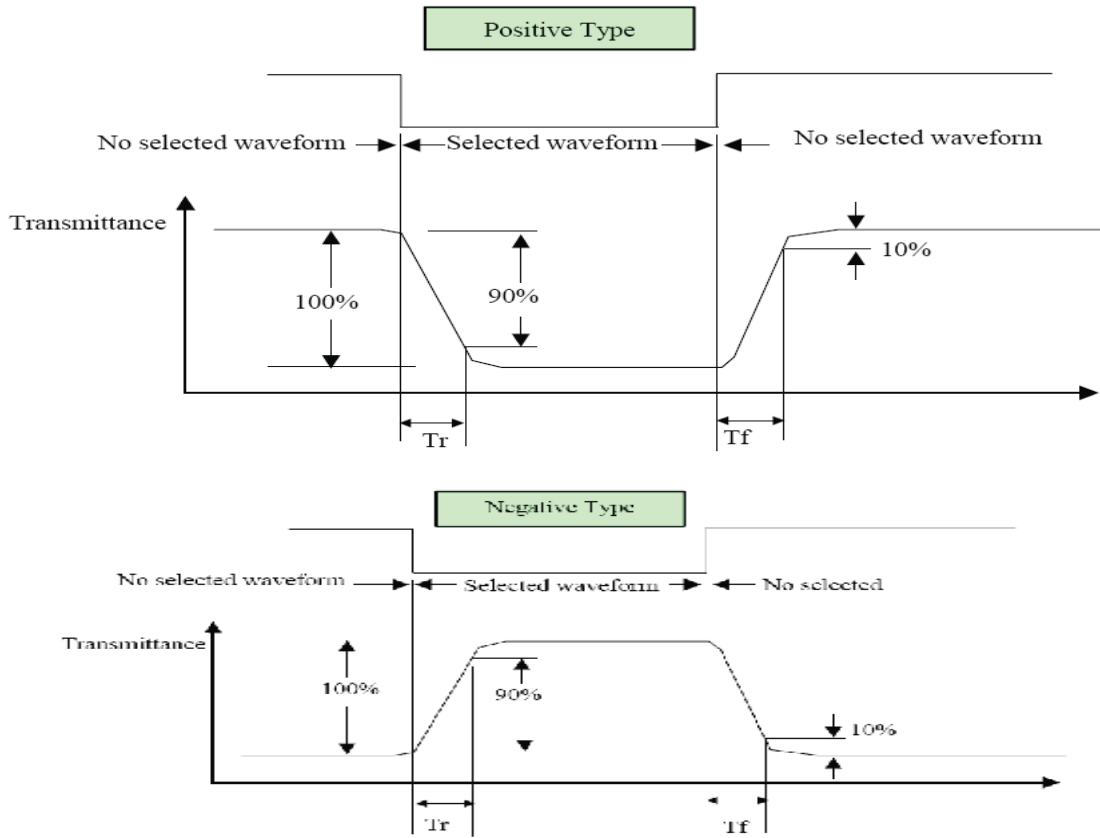

Note(3) Contrast Ratio Definition:

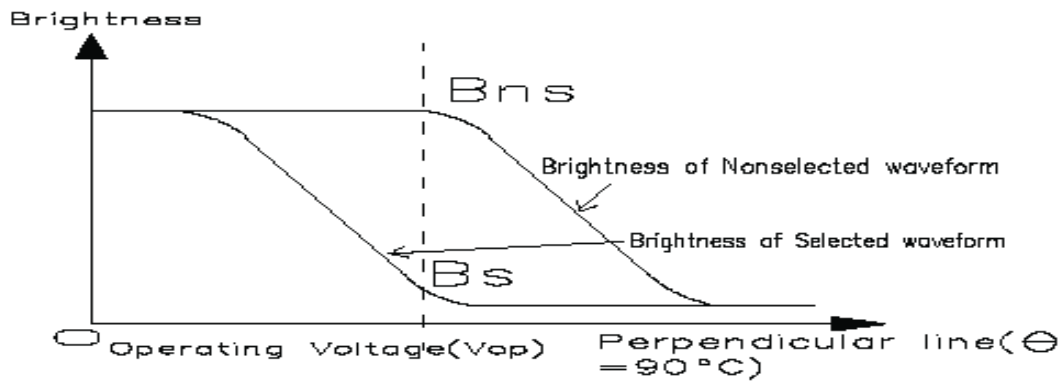

$$\text{Contrast Ratio (Cr)} = \frac{\text{Luminance with all pixel white}}{\text{Luminance with all pixel black}}$$

10. PACKAGE

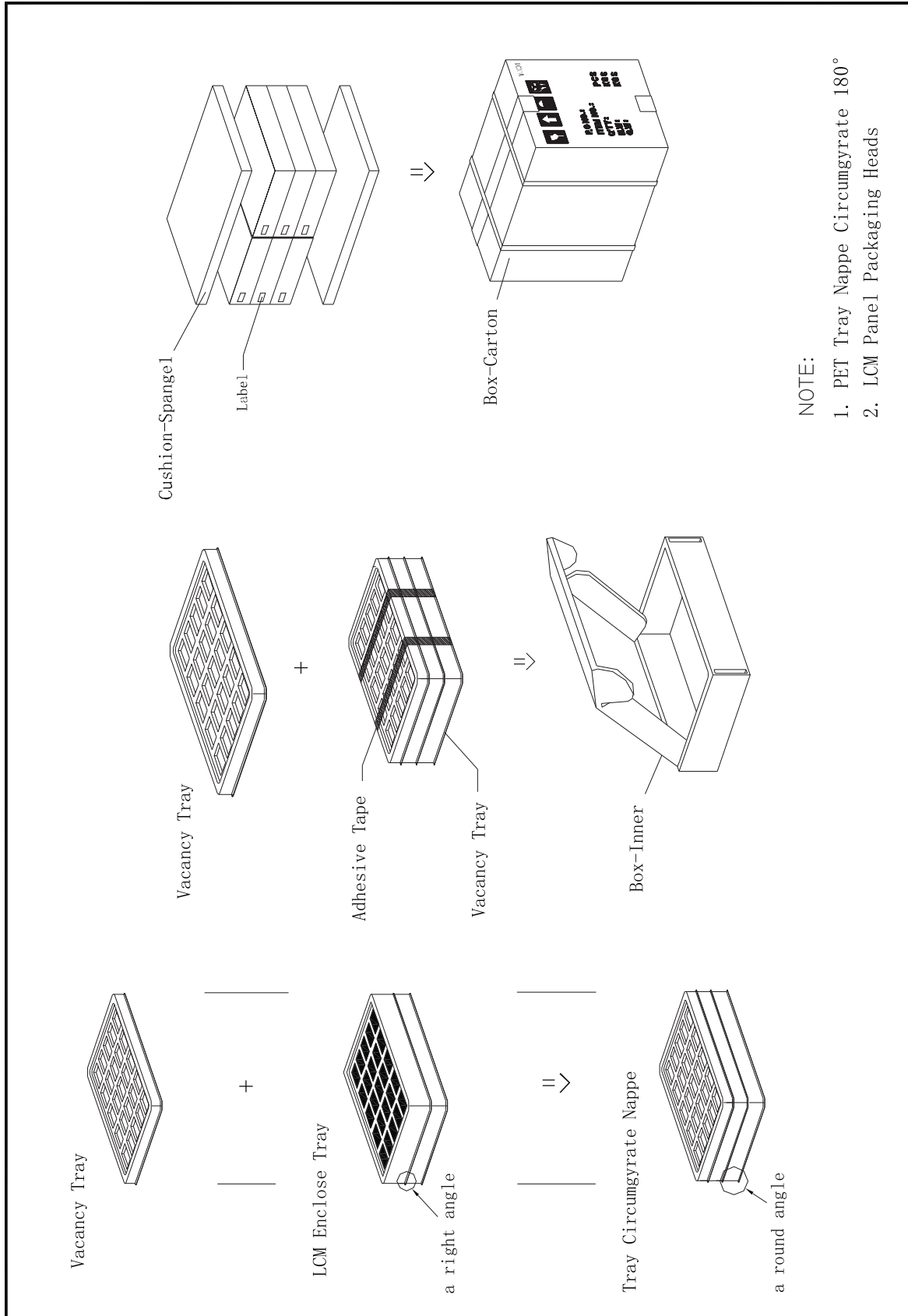

NOTE:

1. PET Tray Nappe Circumgyrate 180°
2. LCM Panel Packaging Heads

11. STANDARD SPECIFICATION FOR RELIABILITY:

Item	Condition	Time (hrs)	Assessment
High temp. Storage	80°C	120	No abnormalities in functions and appearance
High temp. Operating	70°C	120	
Low temp. Storage	-30°C	120	
Low temp. Operating	-20°C	120	
Humidity	40°C/ 90%RH	120	
Thermal Shock Temp. Cycle	-20°C ← 25°C → 70°C (0.5 hour ← 5 min → 0.5 hour)	10cycles	

Functions, performance, appearance, etc. shall be free from remarkable deterioration within 50,000 hours under ordinary operating and storage conditions room temperature (25±10°C), normal humidity (45±20% RH), and in area not exposed to direct sun light. (Life time of backlight, please refer to Data about backlight.)

Testing Conditions and Inspection Criteria:

For the final test the testing sample must be stored at room temperature for 24 hours, after the tests listed in up Table, Standard specifications for Reliability have been executed in order to ensure stability.

Item	Test Model	In section Criteria
Current Consumption	Refer To Specification	The current consumption should conform to the product specification.
Contrast	Refer To Specification	After the tests have been executed, the contrast must be larger than half of its initial value prior to the tests.
Appearance	Visual inspection	Defect free.

12.SPECIFICATION OF QUALITY ASSURANCE:

12.1 Purpose

This standard for Quality Assurance should affirm the quality of LCD Module products to supply to purchaser by Orient Display.

12.2 Standard for Quality Test

a. Inspection:

Before delivering, the supplier should take the following tests, and affirm the quality of product.

b. Electro-Optical Characteristics:

According to the individual specification to test the product.

c. Test of Appearance Characteristics:

According to the individual specification to test the product.

d. Test of Reliability Characteristics:

According to the definition of reliability on the specification for testing products.

e. Delivery Test:

Before delivering, the supplier should take the delivery test.

(i) Test method: According to MIL-STD105E.General Inspection Level II take a single time.

(ii) The defects classify of AQL as following:

Major defect: AQL = 0.65

Minor defect: AQL = 2.5

Total defects: AQL = 2.5

12.3 Nonconforming Analysis & Deal With Manners

a. Nonconforming Analysis:

(i) Purchaser should supply the detail data of non- conforming sample and the non- conforming.

(ii) After accepting the detail data from purchaser, the analysis of nonconforming should be finished in two weeks.

(iii) If supplier can not finish analysis on time, must announce purchaser before two weeks.

b. Disposition of nonconforming:

(i) If find any product defect of supplier during assembly time, supplier must change the good product for every defect after recognition.

(ii) Both supplier and customer should analyze the reason and discuss the disposition of nonconforming when the reason of nonconforming is not sure.

12.4 Agreement items

Both sides should discuss together when the following problems happen.

a. There is any problem of standard of quality assurance, and both sides think that it must be modified.

b. There is any argument item which does not record in the standard of quality assurance.

c. Any other special problem.

12.5 Standard of The Product Appearance Test

a. Manner of appearance test: This specification should be applied for both light on and off situation.

(i) The test must be under 20W × 2 or 40W fluorescent light, and the distance of view must be at 30±5cm.

(ii) When test the model of transmissive product must add the reflective plate.

(iii) The test direction is base on about around 10° of vertical line (Left graph)

(iii) Temperature: 25±5°C Humidity: 65±10%RH

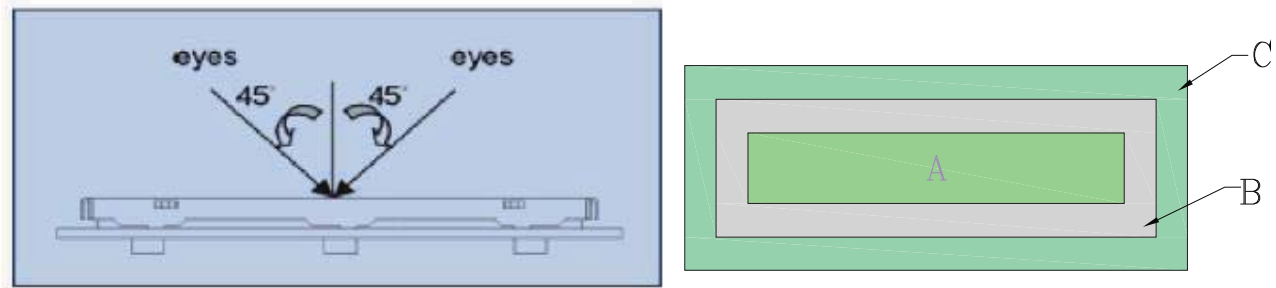

(iv) Definition of area (Right graph)

A. Area: Viewing area. B. Area: Out of viewing area.(Outside viewing area)

b. Basic principle:

(i) It will accord to the AQL when the standard can not be described.

(ii) The sample of the lowest acceptable quality level must be discussed by both supplier and customer when any dispute happened.

(iii) Must add new item on time when it is necessary.

c. Standard of inspection: (Unit: mm)

Allowable limits defined in follow Dot defect Table should be met for each white, black , R, G, B raster.

The limits apply to the entire area. Missing white in 60% or more of typical (one color, R or G or B) pixel aperture is defined as a bright defect, less than 60% is acceptable .Black spot in 60% or more of typical pixel aperture is defined as a dark defect, less than 60% is acceptable.

Dot defect table:

Item		White dot defect	Black dot defect	Total
1	Defect counts	3	3	3
2	Combined defect Counts	No combined dot defect allowed. Two Single dot defect that within 5mm during each dot defect should be counted as combined dot defect.		

12.6 Inspection specification

AQL inspection standard

Sampling method: MIL-STD-105E, Level II, single sampling

Classify	Item		Note	AQL
Major	Display state	Short or open circuit	1	0.65
		Contrast defect (dim, ghost)		
		LC leakage		
		Flickering		
		No display		
		Wrong viewing direction	2	
		Wrong Back-light	7	
	Non-display	Flat cable or pin reverse	9	
		Wrong or missing component	10	
Minor	Display state	Background color deviation	2	2.5
		Black spot and dust	3	
		Line defect	4	
		Scratch		
		Rainbow	5	
		Pin hole	6	
	Polarizer	Bubble and foreign material	3	
		Scratch	4	
	PCB,FPC	Scratch	4	
	Soldering	Poor connection	8	
	Wire	Poor connection	9	
	LCD	CHIP OUT	11	

Note on defect classification:

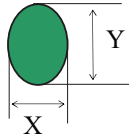
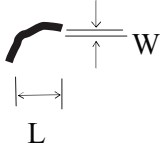
No.	Item	Criterion																				
1	Short or open circuit	Not allow																				
	LC leakage																					
	Flickering																					
	No display																					
	Wrong viewing direction																					
	Wrong Back-light																					
2	Contrast defect	Refer to approval sample																				
	Background color deviation																					
3	<p>Point defect, Black spot, dust (incl. Polarizer) ex.: dirt under polarizer, Pinhole of reflector ,glass scratch, dirt under glass,scratch on polarizer $\phi = (X+Y)/2$</p>	<div style="display: flex; align-items: center; justify-content: center;">  <table border="1" data-bbox="911 816 1317 1085"> <thead> <tr> <th>Point Size</th> <th>Acceptable Qty.</th> </tr> </thead> <tbody> <tr> <td>$\phi \leq 0.10$</td> <td>Disregard</td> </tr> <tr> <td>$0.10 < \phi \leq 0.20$</td> <td>3</td> </tr> <tr> <td>$0.20 < \phi \leq 0.25$</td> <td>2</td> </tr> <tr> <td>$0.25 < \phi \leq 0.30$</td> <td>1</td> </tr> <tr> <td>$\phi > 0.30$</td> <td>0</td> </tr> </tbody> </table> </div> <p style="text-align: center;">Unit: mm</p>	Point Size	Acceptable Qty.	$\phi \leq 0.10$	Disregard	$0.10 < \phi \leq 0.20$	3	$0.20 < \phi \leq 0.25$	2	$0.25 < \phi \leq 0.30$	1	$\phi > 0.30$	0								
Point Size	Acceptable Qty.																					
$\phi \leq 0.10$	Disregard																					
$0.10 < \phi \leq 0.20$	3																					
$0.20 < \phi \leq 0.25$	2																					
$0.25 < \phi \leq 0.30$	1																					
$\phi > 0.30$	0																					
4	Line defect	<div style="display: flex; align-items: center; justify-content: center;">  <table border="1" data-bbox="888 1295 1401 1526"> <thead> <tr> <th></th> <th>Line</th> <th>Acceptable Qty.</th> </tr> <tr> <th>L</th> <th>W</th> <th></th> </tr> </thead> <tbody> <tr> <td>---</td> <td>$0.015 \geq W$</td> <td>Disregard</td> </tr> <tr> <td>$3.0 \geq L$</td> <td>$0.03 \geq W$</td> <td rowspan="2">2</td> </tr> <tr> <td>$2.0 \geq L$</td> <td>$0.05 \geq W$</td> </tr> <tr> <td>$1.0 \geq L$</td> <td>$0.1 > W$</td> <td>1</td> </tr> <tr> <td>---</td> <td>$0.05 < W$</td> <td>Applied as point defect</td> </tr> </tbody> </table> </div> <p style="text-align: center;">Unit: mm</p>		Line	Acceptable Qty.	L	W		---	$0.015 \geq W$	Disregard	$3.0 \geq L$	$0.03 \geq W$	2	$2.0 \geq L$	$0.05 \geq W$	$1.0 \geq L$	$0.1 > W$	1	---	$0.05 < W$	Applied as point defect
	Line	Acceptable Qty.																				
L	W																					
---	$0.015 \geq W$	Disregard																				
$3.0 \geq L$	$0.03 \geq W$	2																				
$2.0 \geq L$	$0.05 \geq W$																					
$1.0 \geq L$	$0.1 > W$	1																				
---	$0.05 < W$	Applied as point defect																				
5	Rainbow	Not more than two color changes across the viewing area																				

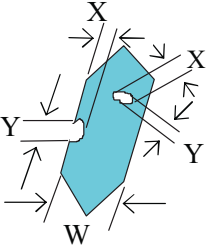
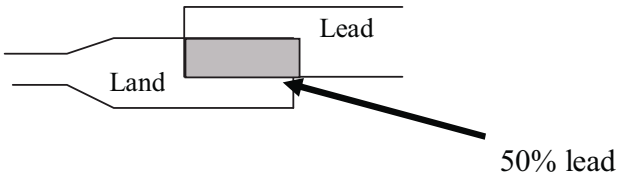
No.	Item	Criterion								
6	<p style="text-align: center;">Segment pattern W = Segment width $\phi = (X+Y)/2$</p>	<p>(1) Pin hole $\phi < 0.15\text{mm}$ is acceptable.</p> <div style="display: flex; justify-content: space-around; align-items: center;">  <table border="1" data-bbox="993 472 1438 653"> <thead> <tr> <th>Point Size</th> <th>Acceptable Qty</th> </tr> </thead> <tbody> <tr> <td>$\phi \leq 1/4W$</td> <td>Disregard</td> </tr> <tr> <td>$1/4W < \phi \leq 1/2W$</td> <td>1</td> </tr> <tr> <td>$\phi > 1/2W$</td> <td>0</td> </tr> </tbody> </table> <p style="text-align: right;">Unit: mm</p> </div>	Point Size	Acceptable Qty	$\phi \leq 1/4W$	Disregard	$1/4W < \phi \leq 1/2W$	1	$\phi > 1/2W$	0
Point Size	Acceptable Qty									
$\phi \leq 1/4W$	Disregard									
$1/4W < \phi \leq 1/2W$	1									
$\phi > 1/2W$	0									
7	Back-light	<p>(1) The color of backlight should correspond its specification. (2) Not allow flickering</p>								
8	Soldering	<p>(1) Not allow heavy dirty and solder ball on PCB or FPC. (The size of dirty refer to point and dust defect) (2) Over 50% of lead should be soldered on Land.</p> <div style="text-align: center;">  </div>								
9	Wire	<p>(1) Copper wire should not be rusted (2) Not allow crack on copper wire connection. (3) Not allow reversing the position of the flat cable. (4) Not allow exposed copper wire inside the flat cable.</p>								
10	PCB,FPC	<p>(1) Not allow screw rust or damage. (2) Not allow missing or wrong putting of component.</p>								

11

LCD

2.1.1 chip on the surface

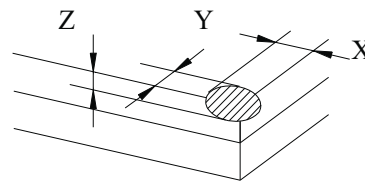
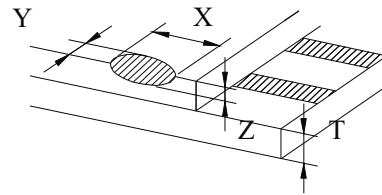
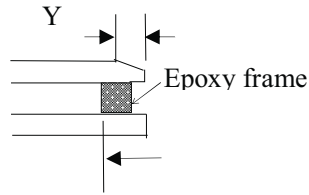
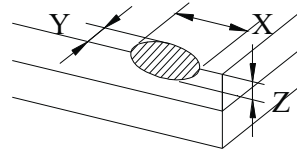

Note: A:LCD Length

X	Y	Z
$>1/8A$	$\leq 0.3\text{mm}$	$\leq 1/2T$
$\leq 1/8A$	Not enter into epoxy frame	$\leq T$
	Not enter into the inner edge of epoxy	$\leq 1/2T$

11

LCD

2.1.2 chip on the terminal

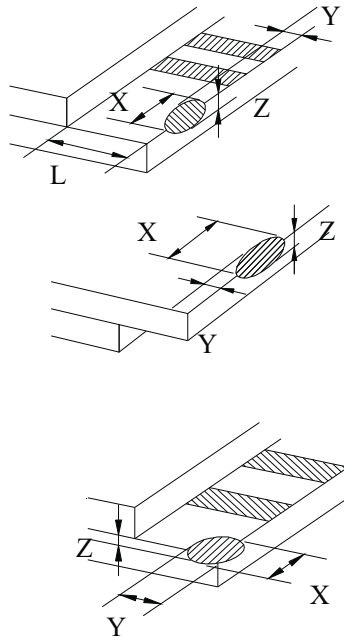

X	Y	Z
$>1/8A$	$\leq 0.3\text{mm}$	$\leq 1/2T$
$\leq 1/8A$	$\leq 1/2L$	$\leq T$
$\leq 1/8A \& \leq 1\text{mm}$	$\leq L$	$\leq T$
$\leq 1/8A \& \leq 2\text{mm}$	$\leq L$	$\leq 1/2T$

Note: A:LCD Length.

the distance between crack and contact pad must be greater than the width of 1st contact pad.

2.1.3 chip out on between side

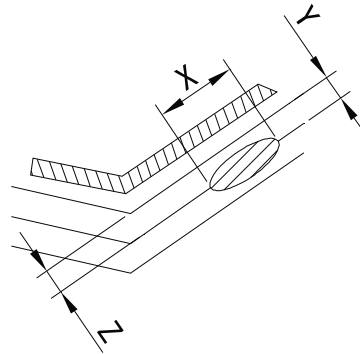

11

LCD

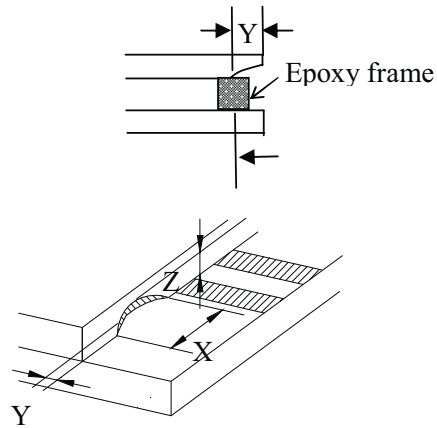

X	Y	Z
$\leq 1/8A$	Not enter into epoxy frame	$Z \leq 2T$
	Not enter into 1/2 epoxy frame	$Z \leq 1/2T$

Note: A : LCD Length

2.1.4 including corner chip and side chip

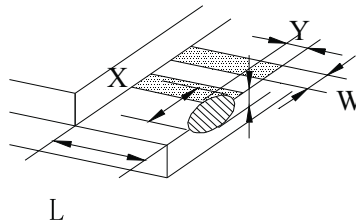

Note: A:LCD Length

X	Y	Z
$>1/8A$	$\leq 1/6L$	$\leq 1/2T$
$\leq 1/8A$	$\leq 1/3L$	
$\leq 1/4W$	$\leq 2/3L$	

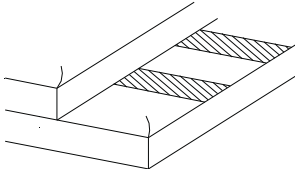
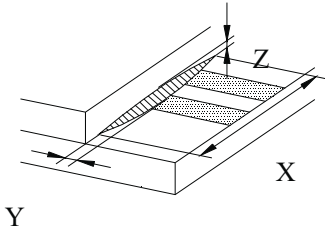
11	LCD	<p>2.2 Chip out</p>  <ol style="list-style-type: none"> 1) Chip out is that crackles extend to inner edge. 2) Crackles round epoxy frame will be rejected. 3) Chip out on the terminal will be rejected: $Z=T$ length $>1\text{mm}$ or $Z<T$ length $>2\text{mm}$ 4) The chip out at ITO will be rejected. 							
		<p>2.3 Poor cutting</p>  <table border="1" data-bbox="698 1010 1146 1241"> <thead> <tr> <th>X</th> <th>Y</th> <th>Z</th> </tr> </thead> <tbody> <tr> <td>$>1/8$ A</td> <td>≤ 0.3</td> <td>$\leq 1/2T$</td> </tr> <tr> <td>$\leq 1/8$ A</td> <td>According to drawing</td> <td>$1/2T \leq Z \leq T$</td> </tr> </tbody> </table> <p>Note : A: LCD Length.</p>	X	Y	Z	$>1/8$ A	≤ 0.3	$\leq 1/2T$	$\leq 1/8$ A
X	Y	Z							
$>1/8$ A	≤ 0.3	$\leq 1/2T$							
$\leq 1/8$ A	According to drawing	$1/2T \leq Z \leq T$							
12	SMT	<p>According to the <Acceptable of electronic assemblies> IPC-A-610C class 2 stander. Component missing or function defect are Major defect ,the others are Minor defect.</p>							
<p>Any one out of the specification will be rejected.</p>									

13. GENERAL PRECAUTIONS

(1) Mounting Method

The panel of the LCD Module consists of two thin glass plates with polarizers which easily get damaged since the Module is fixed by utilizing fitting holes in the printed circuit board. Extreme care should be taken when handling the LCD Modules.

(2) Caution of LCD handling & cleaning

When cleaning the display surface, use soft cloth with solvent (recommended below) and wipe lightly.

- Isopropyl alcohol
- Ethyl alcohol
- Trichlorotrifluoroethane

Do not wipe the display surface with dry or hard materials that will damage the polarizer surface. Do not use the following solvent:

- Water
- Ketone
- Aromatics

(3) Caution against static charge

The LCD Module use C-MOS LSI drivers, so we recommend that you connect any unused input terminal to VDD or VSS, do not input any signals before power is turned on. And ground your body, Work/assembly table. And assembly equipment to protect against static electricity.

(4) Packaging

Modules use LCD elements, and must be treated as such. Avoid intense shock and falls from a height.

- To prevent modules from degradation. Do not operate or store them exposed directly to sunshine or high temperature/humidity.

(5) Caution for operation

- It is indispensable to drive LCD's within the specified voltage limit since the higher voltage than the limit shorten LCD life. An electrochemical reaction due to direct current causes LCD deterioration, Avoid the use of direct current drive.
- Response time will be extremely delayed at lower temperature than the operating temperature range and on the other hand at higher temperature LCD's show dark color in them.

However those phenomena do not mean malfunction or out of order with LCD's which will come back in the specified operating temperature range.

- If the display area is pushed hard during operation, some font will be abnormally displayed but it resumes normal condition after turning off once.

- As light dew depositing on terminals is a cause for electro-chemical reaction resulting in terminal open circuit.

Usage under the relative condition of 40°C, 50%RH or less is required.

(6) Storage

In the case of storing for a long period of time (for instance, for years) for the purpose or replacement use, The following ways are recommended.

- Storage in a polyethylene bag with sealed so as not to enter fresh air outside in it, And with no desiccant.

- Placing in a dark place where neither exposure to direct sunlight nor light is.

Keeping temperature in the specified storage temperature range.

- Storing with no touch on polarizer surface by the anything else. (It is recommended to store them as they have been contained in the inner container at the time of delivery)

(7) Safety

- It is recommendable to crash damaged or unnecessary LCD into pieces and wash off liquid crystal by using solvents such as acetone and ethanol which should be burned up later.

- When any liquid crystal leaked out of a damaged glass cell comes in contact with your hands, please wash it off well with soap and water.

Limited Warranty

The LCM of Orient Display are not consumer products, but may be incorporated by Orient Display's customers into consumer products or components thereof, Orient Display does not warrant that its components are fit for any such particular purpose.

1. The liability of Orient Display is limited to repair or replacement on the terms set forth below. Orient Display will not be responsible for any subsequent or consequential events or injury or damage to any personnel or user including third party personnel and/or user. Unless otherwise agreed in writing between Orient Display and the customer, Orient Display will only replace or repair any of its LCM which is found defective electrically or visually when inspected in accordance with Orient Display.
2. No warranty can be granted if any of the precautions state in handling liquid crystal display above has been disregarded. Broken glass, scratches on polarizer mechanical damages as well as defects that are caused accelerated environment tests are excluded from warranty.
3. In returning the LCM, they must be properly packaged; there should be detailed description of the failures or defect.

Orient Display reserves the right to change this specification.

- END -