



145 Royal Crest Court Unit 42 Markham, ON, Canada L3R 9Z4
Tel: 905-477-1166 Fax: 905-477-1782 <http://www.orientdisplay.com>

SPECIFICATION FOR LCM MODULE

MODULE NO.: AFA320240CT-5.6-A03
DOC. REVISION01

Customer Approval:

--

	SIGNATURE	DATE
PREPARED BY (RD ENGINEER)		
PREPARED BY (QA ENGINEER)		
CHECKED BY		
APPROVED BY		

DOCUMENT REVISION HISTORY

Version	DATE	DESCRIPTION	CHANGED BY
00	2010-08-30	First issue	

CONTENTS

1. Functions & Features	2
2. Mechanical specifications	2
3. Block diagram	2
4. Dimensional Outline	3
5. Pin description	4
6. Maximum absolute limit	4
7. Electrical characteristics	4
8. Backlight Characteristics	5
9. Electro-Optical characteristics	5
10. Timing Characteristics	6
11. Control and Display Instruction	7~9
12. Quality Specifications	10~18

1. Functions & Features

1.1. Format	: 320x240 Dots
1.2. LCD mode	: Transmissive
1.3. Viewing direction	: 6 O'clock
1.4. Display color	: Black/White
1.5. Operation temp	: -20~70 °C
1.6. Storage temp	: -30~80 °C
1.7. Power supply voltage (V _{DD})	: 3.3V
1.8. LED power voltage	: 5.0V
1.9. Backlight color	: White(LED)
1.10 LCM Contrast ratio	: 500:1
1.11 LCM Brightness	: 200 nit(eye)
1.12. RoHS standard	

2. MECHANICAL SPECIFICATIONS

2.1. Module size	: 160.0mm(L)*109.0mm(W)*12.5 max mm (H)
2.2. Viewing area	: 115.0mm(L)*87.0mm(W)
2.3. Dot pitch	: 0.1176(W)*0.3528(H) mm
2.4. Weight	: Approx.

3. BLOCK DIAGRAM

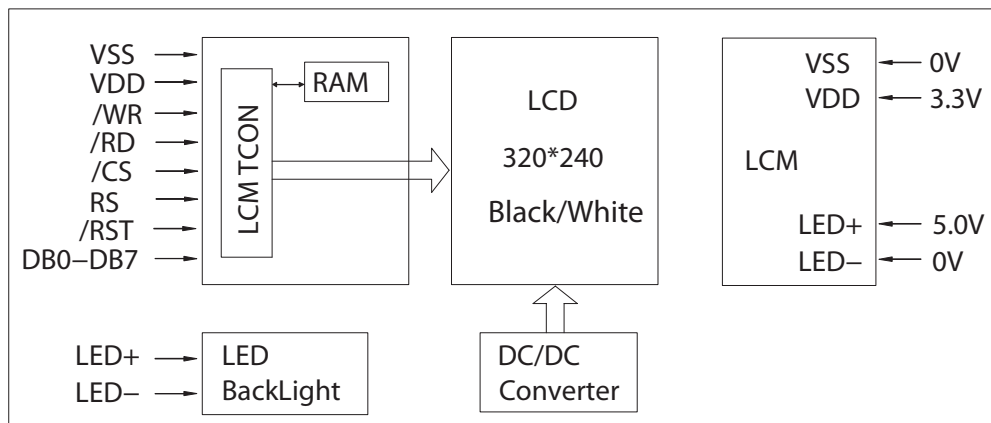

Figure 1. Block diagram

4. DIMENSIONAL OUTLINE

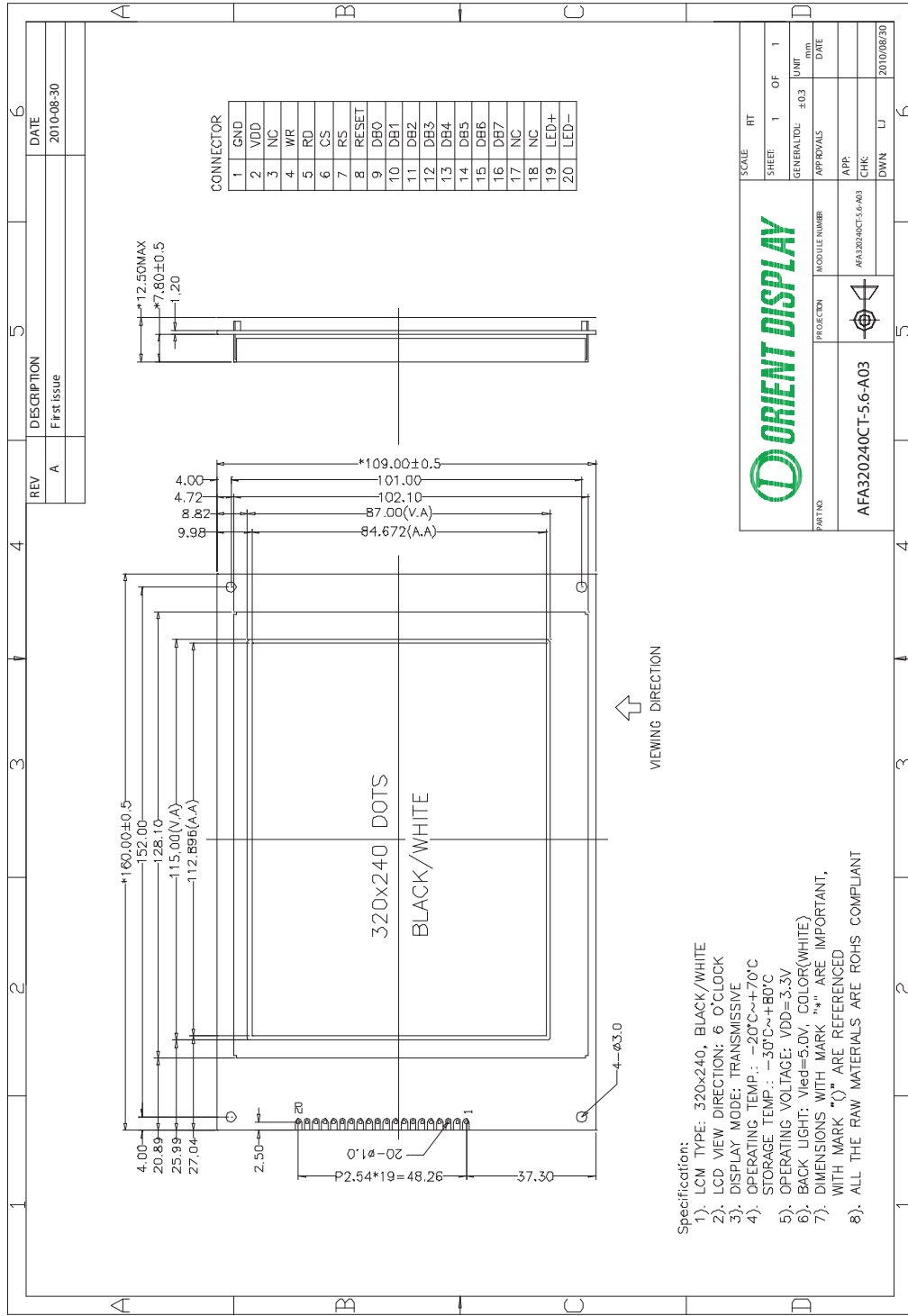

Figure 2. Dimensional outline

5. PIN DESCRIPTION

No.	Symbol	Function
1	VSS	GND
2	VDD	Logic supply voltage (+3.3V)
3	NC	No connection
4	/WR	Write signal
5	/RD	Read signal
6	/CS	Chip enable signal
7	RS	Register selection (H:Data register, L:Instruction register)
8	/RST	Reset signal (L)
9-16	DB0~DB7	Data bus line
17	NC	No connection
18	NC	No connection
19	LED+	Power supply for backlight(+5.0V)
20	LED-	Power supply for backlight(0V)

6. MAXIMUM ABSOLUTE LIMIT

Item	Symbol	MIN	MAX	Unit
Supply Voltage for Logic	V_{DD}	-0.3	7.0	V
Input Voltage	V_{in}	-0.3	$V_{DD}+0.3$	V
Supply Current (Without Backlight)	$I_{DD}(Ta = 25^{\circ}C)$		240	mA
Supply Current for Backlight	$I_F(Ta = 25^{\circ}C)$	---	380	mA
Reverse Voltage for Backlight	$V_R(Ta = 25^{\circ}C)$	---	5.5	V
Operating Temperature	Top	-20	70	$^{\circ}C$
Storage Temperature	Tst	-30	80	$^{\circ}C$

7. ELECTRICAL CHARACTERISTICS

Item	Symbol	Condition	Min	Typ	Max	Unit
Supply Voltage for Logic	$V_{DD}-V_{SS}$	$Ta = 25^{\circ}C$	3.1	3.3	3.5	V
Input High Voltage	V_{IH}	$Ta = 25^{\circ}C$	$0.8V_{DD}$	---	V_{DD}	V
Input Low Voltage	V_{IL}	$Ta = 25^{\circ}C$	0	---	$0.2V_{DD}$	V
Output High Voltage	V_{OH}	$Ta = 25^{\circ}C$	$0.8V_{DD}$	---	V_{DD}	V
Output Low Voltage	V_{OL}		0	---	$0.2V_{DD}$	V
Supply Current (Without Backlight)	I_{DD}	$Ta = 25^{\circ}C$	--	200	240	mA

8. BACKLIGHT CHARACTERISTICS

Ta = 25°C

Item	Symbol	Condition	Min	Typ	Max	Unit
Forward Voltage	V _F	V _{led} =5.0V	48	5.0	5.2	V
Forward Current	I _R	V _{led} =5.0V	---	135	---	mA
Luminous Intensity (With LCD dots off)	I _V	V _{led} =5.0V	150	200	---	Cd/m ²
LED Backlight Color	White					

Item	Symbol	Condition	Min	Typ	Max	Unit
LED Life time	---	Ta = 25°C Humidity: 70% below Forward Current: 20mA	---	50,000	---	Hr

9. ELECTRO-OPTICAL CHARACTERISTICS

(VDD=3.3V, V_{led}=5.0V, Ta = 25°C)

Item	Symbol	Condition	Min	Typ	Max	Unit
Viewing angle (CR≥10)	θ _L	=180°(9 o'clock)	60	70	---	degree
	θ _R	=0°(3 o'clock)	60	70	---	
	θ _T	=90°(12 o'clock)	40	50	---	
	θ _B	=270°(6 o'clock)	60	70	---	
Response time	T _{on}	Normal θ = 0°	---	10	20	ms
	T _{off}		---	15	30	ms
Contrast ratio	Cr		450	500	---	---
Luminance	L1		150	200		Cd/m ²

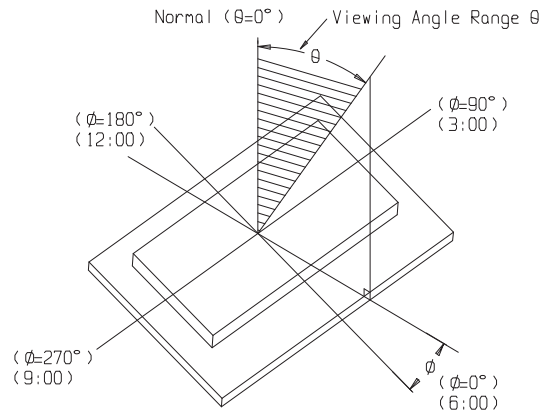
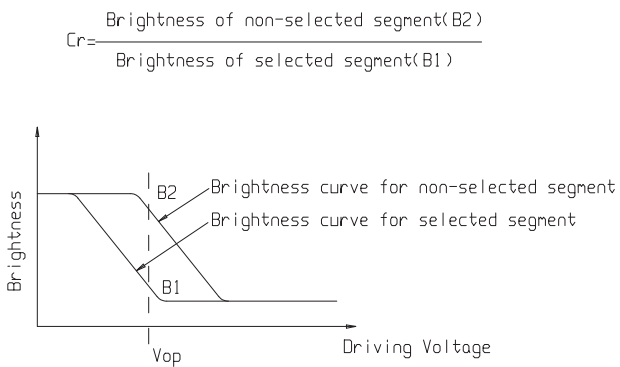

10. TIMING CHARACTERISTICS

10.1 Interface Timing

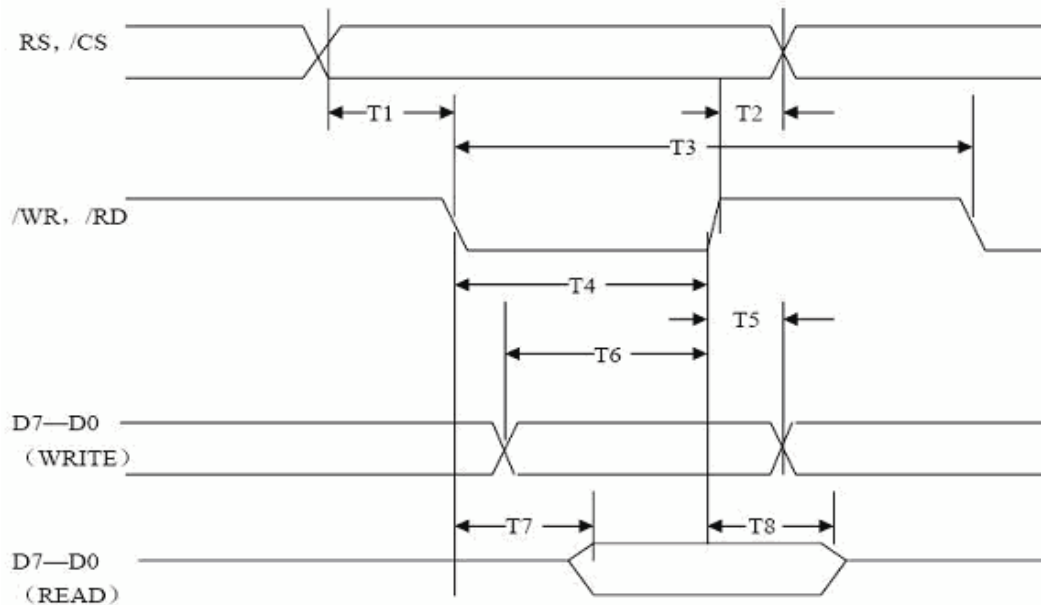

Figure 4. 8080 family Interface Timing

10.2 MCU Interface

Signal	Symbol	Parameter	VDD=3.1-3.5V		Unit	Condition
			Min	Max		
RS,/CS	T2	Address hold time	10	-	ns	CL=100pF
	T1	Address setup time	0	-	ns	
/WR,/RD	T3	System cycle time	350	-	ns	
	T4	Strobe pulsewidth	180	-	ns	
D0-D7	T5	Data hold time	80	-	ns	
	T6	Data setup time	120	-	ns	
	T7	/RD Access time	-	50	ns	
	T8	Output disable time	10	50	ns	

11. CONTROL AND DISPLAY INSTRUCTION

11.1 Instruction

Command (Hex)	Command Code								Function				
	/CS	RS	/WR	/RD	D7	D6	D5	D4		D3	D2	D1	D0
0x80	0	0	0	1	1	0	0	0	0	0	0	0	0
0x81	0	0	0	1	1	0	0	0	0	0	0	0	1
0x82	0	0	0	1	1	0	0	0	0	0	0	1	0
0x83	0	0	0	1	1	0	0	0	0	0	0	1	1
0x84	0	0	0	1	1	0	0	0	0	0	1	0	0
0x85	0	0	0	1	1	0	0	0	0	0	1	0	1
0x86	0	0	0	1	1	0	0	0	0	0	1	1	0
0x87	0	0	0	1	1	0	0	0	0	0	1	1	1
0xa0	0	0	0	1	1	0	1	0	0	0	0	0	0
0xa1	0	0	0	1	1	0	1	0	0	0	0	0	1
0xfc	0	0	0	1	1	1	1	1	1	1	0	0	0
0xfd	0	0	0	1	1	1	1	1	1	1	0	1	0
Address set X(0~39) Y(0~239)	0	0	0	1	0	0	--	--	--	--	--	--	--
	0	0	0	1	0	--	--	--	--	--	--	--	--
Write data	0	1	0	1									
Read data	0	1	1	0									

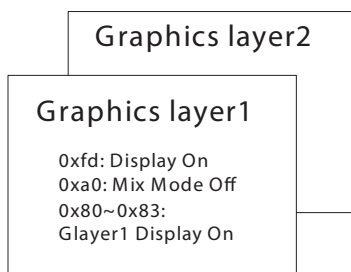

Figure 5.

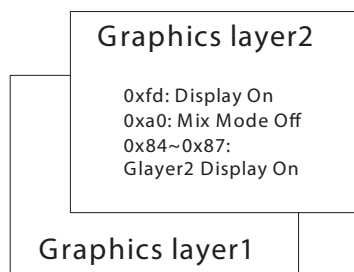

Figure 6.

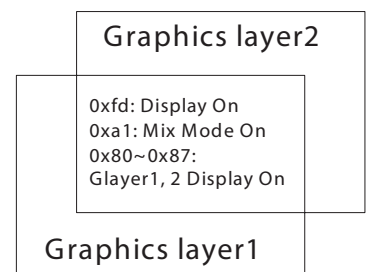

Figure 7.

11.2 Display Data format(Black/White)

MSB				LSB			
DB7	DB6	DB5	DB4	DB3	DB2	DB1	DB0

11.3 Program Example

```
// VDD=3.3V , Vled+=5.0V
#include <reg51.h>
#define uint unsigned int
#define uchar unsigned char

sbit CS   = P3^2;
sbit RS   = P3^3;
sbit WRR  = P3^4;
sbit RDD  = P3^5;
sbit RST  = P3^6;

void wcomd(uchar ch)
{
    RDD=1;RS=0;
    CS=0;
    P1=ch;
    WRR=0;
    WRR=1;
    CS=1;
}

void wdata(uchar ch)
{
    RDD=1;RS=1;
    CS=0;
    P1=ch;
    WRR=0;
    WRR=1;
    CS=1;
}

unsigned char rdata(void)
{
    uchar ch;
    WRR=1;RS=1;
    CS=0;
    P1=0xff;
    RDD=0;
    ch=P1;
    RDD=1;
    CS=1;
    return(ch);
}

void initial()
{
    wcomd(0xfd);    //display on
    wcomd(0xa0);    //mix off
    wcomd(0x80);    //display on Glayer1
}
```

```

void waddr(uint xdat,uint ydat)
{
    wcomd(xdat);
    wcomd(ydat);
}

void disp_all(uchar xsdata)
{
    uint j,k;
    waddr(0x00,0x00);
    for(k=0;k<240;k++)
    {
        for(j=0;j<40;j++)
        { wdata(xsdata);}
    }
}

void main(void)
{
    RST=0;delay(50);RST=1;delay(20);
    initial();
    while(1)
    {
        wcomd(0x80);           //display glayer1 (0x80~0x83)
        disp_all(0xaa);       //write display data
        delay(200);

        wcomd(0x87);           //display glayer2 (0x84~0x87)
        disp_all(0x55);       //write display data
        delay(200);

        wcomd(0xa1);           //mix mode on
        delay(200);
        wcomd(0xa0);           //mix mode off
        delay(200);

        wcomd(0xfc);           //display off
        delay(200);
        wcomd(0xfd);           //display on
        delay(200);

        .....
    }
}

```

12.QUALITY SPECIFICATIONS

12.1 Standard of the product appearance test

Manner of appearance test: This inspection should be performed in using 20W x 2 fluorescent lamps. Distance between LCM and fluorescent lamps should be 100 cm or more. Distance between LCM and inspector eyes should be 30 cm or more.

Viewing direction for inspection is 45° from vertical against LCM.

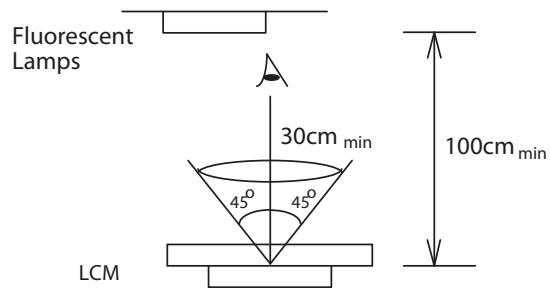

Definition of zone:

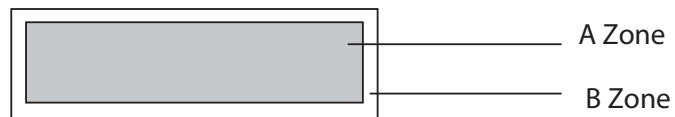

A Zone: Active display area (minimum viewing area).

B Zone: Non-active display area (outside viewing area).

12.2 Specification of quality assurance

AQL inspection standard

Sampling method: MIL-STD-105E, Level II, single sampling

Defect classification (Note: * is not including)

Classify	Item		Note	AQL
Major	Display state	Short or open circuit	1	0.65
		LC leakage		
		Flickering		
		No display		
		Wrong viewing direction		
		Contrast defect (dim, ghost)	2	
		Back-light	1,8	
	Non-display	Flat cable or pin reverse	10	
Wrong or missing component		11		
Minor	Display state	Background color deviation	2	1.0
		Black spot and dust	3	
		Line defect, Scratch	4	
		Rainbow	5	
		Chip	6	
		Pin hole	7	
	Polarizer	Protruded	12	
		Bubble and foreign material	3	
	Soldering	Poor connection	9	
	Wire	Poor connection	10	
	TAB	Position, Bonding strength	13	

Note on defect classification

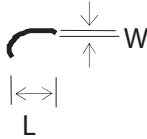
No.	Item	Criterion																				
1	Short or open circuit	Not allow																				
	LC leakage																					
	Flickering																					
	No display																					
	Wrong viewing direction																					
	Wrong Back-light																					
2	Contrast defect	Refer to approval sample																				
	Background color deviation																					
3	Point defect, Black spot, dust (including Polarizer) $\varphi = (X+Y)/2$	 <table border="1" data-bbox="922 919 1318 1188"> <thead> <tr> <th>Point Size</th> <th>Acceptable Qty.</th> </tr> </thead> <tbody> <tr> <td>$\varphi \leq 0.10$</td> <td>Disregard</td> </tr> <tr> <td>$0.10 < \varphi \leq 0.20$</td> <td>3</td> </tr> <tr> <td>$0.20 < \varphi \leq 0.25$</td> <td>2</td> </tr> <tr> <td>$0.25 < \varphi \leq 0.30$</td> <td>1</td> </tr> <tr> <td>$\varphi > 0.30$</td> <td>0</td> </tr> </tbody> </table> <p>Unit: mm</p>	Point Size	Acceptable Qty.	$\varphi \leq 0.10$	Disregard	$0.10 < \varphi \leq 0.20$	3	$0.20 < \varphi \leq 0.25$	2	$0.25 < \varphi \leq 0.30$	1	$\varphi > 0.30$	0								
Point Size	Acceptable Qty.																					
$\varphi \leq 0.10$	Disregard																					
$0.10 < \varphi \leq 0.20$	3																					
$0.20 < \varphi \leq 0.25$	2																					
$0.25 < \varphi \leq 0.30$	1																					
$\varphi > 0.30$	0																					
4	Line defect, Scratch	 <table border="1" data-bbox="857 1348 1356 1583"> <thead> <tr> <th colspan="2">Line</th> <th>Acceptable Qty.</th> </tr> <tr> <th>L</th> <th>W</th> <th></th> </tr> </thead> <tbody> <tr> <td>---</td> <td>$0.015 \geq W$</td> <td>Disregard</td> </tr> <tr> <td>$5.0 \geq L$</td> <td>$0.03 \geq W$</td> <td rowspan="2">2</td> </tr> <tr> <td>$5.0 \geq L$</td> <td>$0.05 \geq W$</td> </tr> <tr> <td>$5.0 \geq L$</td> <td>$0.1 > W$</td> <td>1</td> </tr> <tr> <td>---</td> <td>$0.05 < W$</td> <td>Applied as point defect</td> </tr> </tbody> </table> <p>Unit: mm</p>	Line		Acceptable Qty.	L	W		---	$0.015 \geq W$	Disregard	$5.0 \geq L$	$0.03 \geq W$	2	$5.0 \geq L$	$0.05 \geq W$	$5.0 \geq L$	$0.1 > W$	1	---	$0.05 < W$	Applied as point defect
Line		Acceptable Qty.																				
L	W																					
---	$0.015 \geq W$	Disregard																				
$5.0 \geq L$	$0.03 \geq W$	2																				
$5.0 \geq L$	$0.05 \geq W$																					
$5.0 \geq L$	$0.1 > W$	1																				
---	$0.05 < W$	Applied as point defect																				
5	Rainbow	Not more than two color changes across the viewing area.																				

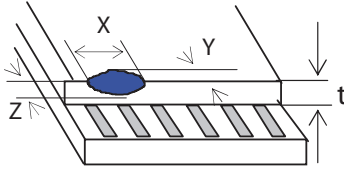
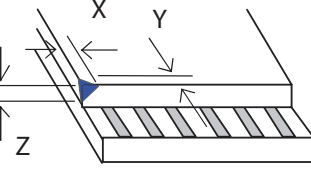
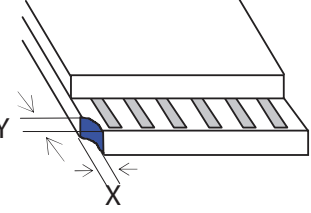
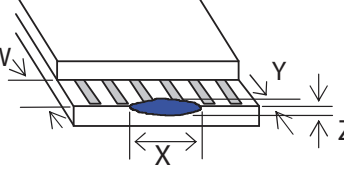
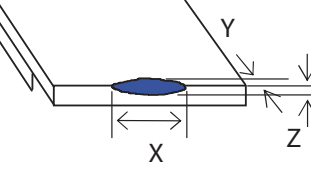
No	Item	Criterion																																	
6	<p>Chip</p> <p>Remark: X: Length direction Y: Short direction Z: Thickness direction t: Glass thickness W: Terminal Width</p>	 <p>Acceptable criterion</p> <table border="1" data-bbox="982 409 1339 493"> <thead> <tr> <th>X</th> <th>Y</th> <th>Z</th> </tr> </thead> <tbody> <tr> <td>≤ 2</td> <td>0.5mm</td> <td>$\leq t/2$</td> </tr> </tbody> </table>  <p>Acceptable criterion</p> <table border="1" data-bbox="974 703 1339 777"> <thead> <tr> <th>X</th> <th>Y</th> <th>Z</th> </tr> </thead> <tbody> <tr> <td>≤ 3</td> <td>0.5mm</td> <td>$\leq t$</td> </tr> </tbody> </table>  <p>Acceptable criterion</p> <table border="1" data-bbox="982 966 1339 1081"> <thead> <tr> <th>X</th> <th>Y</th> <th>Z</th> </tr> </thead> <tbody> <tr> <td>≤ 3</td> <td>≤ 2</td> <td>$\leq t$</td> </tr> <tr> <td colspan="2">shall not reach to ITO</td> <td></td> </tr> </tbody> </table>  <p>Acceptable criterion</p> <table border="1" data-bbox="974 1312 1339 1386"> <thead> <tr> <th>X</th> <th>Y</th> <th>Z</th> </tr> </thead> <tbody> <tr> <td>Disregard</td> <td>≤ 0.2</td> <td>$\leq t$</td> </tr> </tbody> </table>  <p>Acceptable criterion</p> <table border="1" data-bbox="974 1575 1307 1648"> <thead> <tr> <th>X</th> <th>Y</th> <th>Z</th> </tr> </thead> <tbody> <tr> <td>≤ 5</td> <td>≤ 2</td> <td>$\leq t/3$</td> </tr> </tbody> </table>	X	Y	Z	≤ 2	0.5mm	$\leq t/2$	X	Y	Z	≤ 3	0.5mm	$\leq t$	X	Y	Z	≤ 3	≤ 2	$\leq t$	shall not reach to ITO			X	Y	Z	Disregard	≤ 0.2	$\leq t$	X	Y	Z	≤ 5	≤ 2	$\leq t/3$
X	Y	Z																																	
≤ 2	0.5mm	$\leq t/2$																																	
X	Y	Z																																	
≤ 3	0.5mm	$\leq t$																																	
X	Y	Z																																	
≤ 3	≤ 2	$\leq t$																																	
shall not reach to ITO																																			
X	Y	Z																																	
Disregard	≤ 0.2	$\leq t$																																	
X	Y	Z																																	
≤ 5	≤ 2	$\leq t/3$																																	

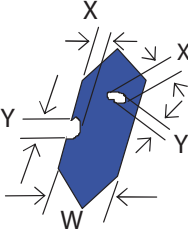
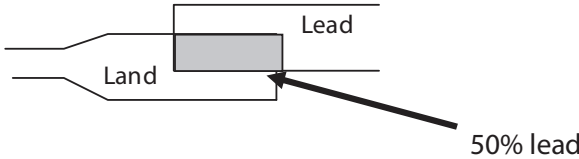
No.	Item	Criterion								
7	Segment pattern $W = \text{Segment width}$ $\phi = (X+Y)/2$	(1) Pin hole $\phi < 0.10\text{mm}$ is acceptable.  <table border="1" data-bbox="917 535 1331 703"> <thead> <tr> <th>Point Size</th> <th>Acceptable Qty</th> </tr> </thead> <tbody> <tr> <td>$\phi \leq 1/4W$</td> <td>Disregard</td> </tr> <tr> <td>$1/4W < \phi \leq 1/2W$</td> <td>1</td> </tr> <tr> <td>$\phi > 1/2W$</td> <td>0</td> </tr> </tbody> </table> <p style="text-align: center;">Unit: m m</p>	Point Size	Acceptable Qty	$\phi \leq 1/4W$	Disregard	$1/4W < \phi \leq 1/2W$	1	$\phi > 1/2W$	0
Point Size	Acceptable Qty									
$\phi \leq 1/4W$	Disregard									
$1/4W < \phi \leq 1/2W$	1									
$\phi > 1/2W$	0									
8	Back-light	(1) The color of backlight should correspond its specification. (2) Not allow flickering								
9	Soldering	(1) Not allow heavy dirty and solder ball on PCB. (The size of dirty refer to point and dust defect) (2) Over 50% of lead should be soldered on Land. 								
10	Wire	(1) Copper wire should not be rusted (2) Not allow crack on copper wire connection. (3) Not allow reversing the position of the flat cable. (4) Not allow exposed copper wire inside the flat cable.								
11*	PCB	(1) Not allow screw rust or damage. (2) Not allow missing or wrong putting of component.								

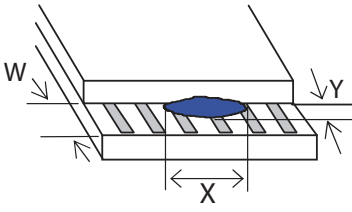
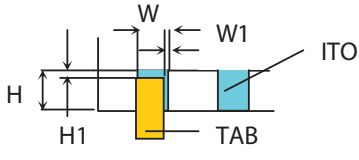
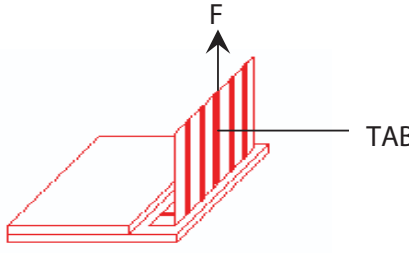
No	Item	Criterion
12	Protruded W: Terminal Width	 <p>Acceptable criteria: $Y \leq 0.4$</p>
13	TAB	<p>1. Position</p>  <div style="border: 1px solid black; padding: 5px; width: fit-content; margin-left: auto;"> $W1 \leq 1/3W$ $H1 \leq 1/3H$ </div> <p>2 TAB bonding strength test</p>  <p>$P (=F/TAB \text{ bonding width}) \geq 650\text{gf/cm}$,(speed rate: 1mm/min) 5pcs per SOA (shipment)</p>
14	Total no. of acceptable Defect	<p>A. Zone</p> <p>Maximum 2 minor non-conformities per one unit. Defect distance: each point to be separated over 10mm</p> <p>B. Zone</p> <p>It is acceptable when it is no trouble for quality and assembly in customer's end product.</p>

12.3 Reliability of LCM

Reliability test condition:

Item	Condition	Time (hrs)	Assessment
High temp. Storage	80°C	48	No abnormalities in functions and appearance
High temp. Operating	70°C	48	
Low temp. Storage	-30°C	48	
Low temp. Operating	-20°C	48	
Humidity	40°C/ 90%RH	48	
Temp. Cycle	-20°C ← 25°C → 70°C (30 min ← 5 min → 30min)	10cycles	

Recovery time should be 24 hours minimum. Moreover, functions, performance and appearance, etc. shall be free from remarkable deterioration within 50,000 hours under ordinary operating and storage conditions room temperature ($20 \pm 8^\circ\text{C}$), normal humidity (below $45 \pm 20\%$ RH), and in the area not exposed to direct sun light. The life time is not content the life time of the LED (for the life time of LED which decay only 50%, in the industry the experience value is 50000 hours, but there are not any experimentation data to support this).

12.4 Precaution for using LCD/LCM

LCD/LCM is assembled and adjusted with a high degree of precision. Do not attempt to make any alteration or modification. The followings should be noted.

General Precautions:

1. LCD panel is made of glass. Avoid excessive mechanical shock or applying strong pressure onto the surface of display area.
2. The polarizer used on the display surface is easily scratched and damaged. Extreme care should be taken when handling. To clean dust or dirt off the display surface, wipe gently with cotton, or other soft material soaked with isopropyl alcohol, ethyl alcohol or trichlorotrifluoroethane, do not use water, ketone or aromatics and never scrub hard.
3. Do not tamper in any way with the tabs on the metal frame.
4. Do not make any modification on the PCB without consulting Orient Display.
5. When mounting a LCM, make sure that the PCB is not under any stress such as bending or twisting. Elastomer contacts are very delicate and missing pixels could result from slight dislocation of any of the elements.

6. Avoid pressing on the metal bezel, otherwise the elastomer connector could be deformed and lose contact, resulting in missing pixels and also cause rainbow on the display.
7. Be careful not to touch or swallow liquid crystal that might leak from a damaged cell. Any liquid crystal adheres to skin or clothes, wash it off immediately with soap and water.

Static Electricity Precautions:

1. CMOS-LSI is used for the module circuit; therefore operators should be grounded whenever he/she comes into contact with the module.
2. Do not touch any of the conductive parts such as the LSI pads; the copper leads on the PCB and the interface terminals with any parts of the human body.
3. Do not touch the connection terminals of the display with bare hand; it will cause disconnection or defective insulation of terminals.
4. The modules should be kept in anti-static bags or other containers resistant to static for storage.
5. Only properly grounded soldering irons should be used.
6. If an electric screwdriver is used, it should be grounded and shielded to prevent sparks.
7. The normal static prevention measures should be observed for work clothes and working benches.
8. Since dry air is inductive to static, a relative humidity of 50-60% is recommended.

Soldering Precautions:

1. Soldering should be performed only on the I/O terminals.
2. Use soldering irons with proper grounding and no leakage.
3. Soldering temperature: $280^{\circ}\text{C} \pm 10^{\circ}\text{C}$
4. Soldering time: 3 to 4 second.
5. Use eutectic solder with resin flux filling.
6. If flux is used, the LCD surface should be protected to avoid spattering flux.
7. Flux residue should be removed.

Operation Precautions:

1. The viewing angle can be adjusted by varying the LCD driving voltage V_o .
2. Since applied DC voltage causes electro-chemical reactions, which deteriorate the display, the applied pulse waveform should be a symmetric waveform such that no DC component remains. Be sure to use the specified operating voltage.
3. Driving voltage should be kept within specified range; excess voltage will shorten display life.
4. Response time increases with decrease in temperature.
5. Display color may be affected at temperatures above its operational range.
6. Keep the temperature within the specified range usage and storage. Excessive temperature and humidity could cause polarization degradation, polarizer peel-off or generate bubbles.
7. For long-term storage over 40°C is required, the relative humidity should be kept below 60%, and avoid direct sunlight.

Limited Warranty

Orient Display LCDs and modules are not consumer products, but may be incorporated by OD's customers into consumer products or components thereof, Orient Display does not warrant that its LCDs and components are fit for any such particular purpose.

1. The liability of Orient Display is limited to repair or replacement on the terms set forth below. Orient Display will not be responsible for any subsequent or consequential events or injury or damage to any personnel or user including third party personnel and/or user. Unless otherwise agreed in writing between Orient Display and the customer, Orient Display will only replace or repair any of its LCD which is found defective electrically or visually when inspected in accordance with Orient Display general LCD inspection standard. (Copies available on request)
2. No warranty can be granted if any of the precautions state in handling liquid crystal display above has been disregarded. Broken glass, scratches on polarizer mechanical damages as well as defects that are caused accelerated environment tests are excluded from warranty.
3. In returning the LCD/LCM, they must be properly packaged; there should be detailed description of the failures or defect.